

BELGIAN SCIENCE POLICY



# Belgian global change research 1990-2002

Assessment and integration report



Main editors:

**G. den Ouden, M. Vanderstraeten**

Scientific editors:

**R. Ceulemans, M. De Mazière, I. Nijs,  
J.-P. Vanderborght, J.-P. van Ypersele,  
R. Wollast, R. Zander**

.be

Results of global change research activities realised between 1990 and 2002, supported by the Belgian Federal Science Policy Office (BELSPO), were subject to an assessment and integration in 2003 and 2004. This process focussed on a selection of scientific information, based on data provided by Belgian researchers, and resulted in two reports:

- ✓ Belgian global change research 1990 – 2002 : Assessment and integration report
- ✓ Belgian global change research 1990 – 2002 : Synthesis of the assessment and integration report

This report is the extended assessment and integration report. The synthesis of this report is available in Dutch, English and French. Both reports emphasise the following four topics:

- ✓ Atmospheric composition changes
- ✓ Climate change
- ✓ The role of the ocean in global change
- ✓ Global change impacts on ecosystems



# **Belgian global change research 1990-2002**

**Assessment and integration report**

Main editors:

**G. den Ouden, M. Vanderstraeten**

Scientific editors:

**R. Ceulemans, M. De Mazière, I. Nijs,  
J.-P. Vanderborght, J.-P. van Ypersele,  
R. Wollast, R. Zander**



## Introduction

Authors: G. den Ouden and M. Vanderstraeten

With contributions from: D. Cox, N. Henry, F. Monteny, M. Van Cauwenberghe, and A. Van Der Werf (BELSPO)

## Chapter 1: Atmospheric composition changes: causes and processes involved

Science editors: R. Zander (ULg-GIRPAS) and M. De Mazière (BIRA / IASB)

With contributions from: E. Arijis (BIRA / IASB), C. Bingen (BIRA / IASB), B. Barret (BIRA / IASB), M. Claeys (UA), R. Colin (ULB-SPECAT), H. De Backer (IRM / KMI), S. Fally (ULB-SPECAT), D. Fonteyn (BIRA / IASB), D. Fussen (BIRA / IASB), D. Gillotay (BIRA / IASB), F. Hendrick (BIRA / IASB), J.-C. Lambert, (BIRA / IASB), W. Maenhaut (UGent-INW), E. Mahieu (ULg-GIRPAS), C. Mensink (VITO), J.-F. Muller (BIRA / IASB), J. Peeters (KULeuven), R. Van Grieken (UA-MiTAC), M. Van Roozendaal (BIRA / IASB), C. Vinckier (KULeuven-PAC)

## Chapter 2: Climate change

Science editor: J.-P. van Ypersele (UCL-ASTR)

Supported by: Ph. Van Haver, S. Vanhomwegen, E. Vanvyve, V. Coulon and Ph. Marbaix (UCL-ASTR)

With contributions from: A. Berger (UCL-ASTR), F. Charlet (UGent-RCMG), C. Cocquyt (UGent-PAE), M. Crucifix (UCL-ASTR), M. De Batist (UGent-RCMG), H. Declerck (VUB-DG), N. Fagel (ULg-URAP), Th. Fichet (UCL-ASTR), H. Goosse (UCL-ASTR), Ph. Huybrechts (VUB-DG), R. Lorrain (ULB-GLACIOL), E. Mahieu (ULg-GIRAS), F. Pattyn (VUB-DG), P.-D. Plisnier (KMMA / MRAC), J. Smits (ULg-CEME), J.-L. Tison (ULB-GLACIOL), C. Tricot (IRM / KMI), W. Vyverman (UGent-PAE), P. Willenz (IRSNB / KBIN), R. Zander (ULg-GIRPAS)

## Chapter 3: The role of the ocean in global change

Science editors: R. Wollast and J.-P. Vanderborght (ULB-OCEAN)

Supported by: M. Loijens (ULB-OCEAN)

With contributions from: L. André (KMCA/MRAC), W. Baeyens (VUB-ANCH), S. Becquevort (ULB-ESA), A. Borges (ULg-OCEANCHEM), N. Brion (VUB-ANCH), D. Cardinal (KMCA/MRAC), L. Chou (ULB-OCEAN), F. Dehairs (VUB-ANCH), B. Delille (ULg-OCEANCHEM), M. Elskens (VUB-ANCH), M. Frankignoulle (ULg-OCEANCHEM), A. Mouchet (ULg-LPAP), C. Lancelot (ULB-ESA), M. Leermakers (VUB-ANCH), G. Pichot (IRSNB/KBIN), V. Rousseau (ULB-ESA), V. Schoemann (ULB-ESA), R. Van Grieken (UA-MiTAC), M. Vincx (UGent-MARBIOL)

## Chapter 4: Global change impact on ecosystems

Science editors: R. Ceulemans and I. Nijs (UA-PLECO)

Supported by: L. Van Peer (UA-PLECO)

With contributions from: P. Boeckx (UGent-ISOFYS), L. François (ULg-LPAP), E. Le Boulengé (UCL-ECOL), H. Geist (UCL-GEOG), R. Lemeur (UGent-PLANTECO), P. Meire (UA-ECOBÉ), C. Sohier (FUSAGx-UHAGx), V. Van Haesebroeck (UA-ECOBÉ), B. van Wesemael (UCL-GEOG), F. Veroustraete (VITO-TAP)

Overall review: Ph. Bourdeau (ULB-IGEAT), J. Tack (IGBP national committee and Belgian Biodiversity Platform) and M. Stelandre (BELSPO).

Illustrative material: various researchers and institutions.

### In Memoriam Prof. Roland Wollast

During the finalisation of the current report, our science editor Roland Wollast passed away on 28 July 2004. We all remember him as an outstanding scientist and as a very dedicated person both within his scientific domain of marine sciences as well as with regard to his excellent multi-disciplinary approach in integrating his science with other natural science domains of which this report was his latest effort.



**R**esearch is the cornerstone of any science. Its goal is to improve our general understanding of things around us. With increasing understanding of relationships between natural and anthropogenic activities, global change research is crucial to selecting policy objectives related to environmental protection, human well-being and economic development. It is recognised as a major pillar of the European Sustainable Development Strategy (Göteborg 2001) and of the implementation plan of the UN World Summit on Sustainable Development (Johannesburg 2002). Current European research policy towards global change research tends to reinforce cooperation between European and global research initiatives.

Results of global change research activities realised between 1990 and 2002, supported by the Belgian Federal Science Policy Office (BELSPO), were subject to an assessment and integration. This process focussed on a selection of scientific information and resulted in the following two reports:

- ✓ Belgian global change research 1990 – 2002: Assessment and integration report
- ✓ Belgian global change research 1990 – 2002: Synthesis of the assessment and integration report

The thematic sections of the assessment and integration report are structured around policy-relevant questions and answers. Apart from policy-supporting tools and neutral advice, this 'state-of-the-art' knowledge document also provides an overview of the relevant scientific knowledge and expertise in Belgium. It seeks to explain what the challenges are that global change puts before us, what views Belgian and international scientists hold about global change and its impact, what their research results are and how these can contribute to better decision-making and policy development.

The active and enthusiastic involvement of so many scientists in producing this report and the good collaborative spirit among them proves that there is a 'Belgian global change research community', sharing knowledge and ideas. Although the task was complex and very different from their daily work, they experienced the translation process of research outputs into a policy-oriented document as interesting and instructive. A large proportion of the scientists that contributed to this process is unfamiliar with policy actors and views the area between these actors and themselves as a twilight zone. They have expressed the feeling that this report will contribute to bridging the gap.

To make this assessment and integration report accessible to both policymakers and the general public, an additional concise interpretation has been drafted by a science writer. This resulted in a synthesis report that has been further edited by the main editors G. den Ouden and M. Vanderstraeten in close co-operation with the science editors named hereafter.

Within Belgium, the 'Scientific support plan for a sustainable development policy' (SPSD) programme is one of the major initiatives funding global change research. The Belgian Federal Science Policy Office also acknowledges the importance of other partners, international or Belgian, that contribute to the funding of Belgian global change research.

I would like to thank the science editors from the complete 'Assessment and integration report': R. Zander (ULg-GIRPAS), M. De Mazière (BIRA / IASB), J.-P. van Ypersele (UCL-ASTR), R. Wollast and J.-P. Vanderborght (ULB-OCEAN), and R. Ceulemans and I. Nijs (UA-PLECO). In particular, I wish to pay tribute to Prof. Wollast, who passed away recently. His last contribution to the production of this report proved his scientific expertise, his skill at synthesizing, and his holistic view of global change issues. His death is a great loss to the international scientific community.

I wish to express my sincere gratitude to all the scientists on whose work the report is based and those who participated actively in the assessment and integration process, to the involved BELSPO colleagues, as well as to the science writer, reviewers, translators and language revisers. I hope that such fruitful collaboration will continue.



Dr. Philippe Mettens,  
Chairman of the Board of Directors





<b>Editors and Contributors</b>	<b>3</b>
<b>Foreword</b>	<b>5</b>
<b>Executive Summary</b>	<b>11</b>
<b>Introduction</b>	
<b>What is Global Change?</b>	<b>19</b>
<b>Global Change research</b>	<b>20</b>
Why is research on global change important?	
How is global change research organised?	
<b>Providing policymakers with results and expertise related to BELSPO projects</b>	<b>22</b>
What types of research outputs are there?	
What are the transfer mechanisms?	
What is the facilitating role of BELSPO?	
<b>The Assessment and Integration process</b>	<b>25</b>
What are the aims of this report?	
How was this report prepared?	
<b>1. Atmospheric composition changes: causes and processes involved</b>	
<b>1.1 How did stratospheric ozone evolve in the 1990s, will it recover, and how does it affect climate and UV irradiance levels at the surface?</b>	<b>29</b>
1.1.1 Introduction	
1.1.2 Do we understand the Arctic O <sub>3</sub> depletion processes?	
1.1.3 How has O <sub>3</sub> changed over highly populated northern mid-latitude regions?	
1.1.4 What is the impact of stratospheric aerosols on O <sub>3</sub> depletion?	
1.1.5 What is the impact of ozone layer depletion on climate and UV radiation at ground level?	
1.1.6 Is stratospheric ozone layer depletion under control and when will it recover?	
<b>1.2 Can we quantify the evolution of the tropospheric ozone content and the related roles of VOC and nitrogen emissions?</b>	<b>38</b>
1.2.1 Introduction	
1.2.2 How is the background tropospheric O <sub>3</sub> changing, does it affect climate, and how will it evolve in the future?	
1.2.3 What have been the observed trends in episodic peak concentrations of tropospheric ozone and VOC emissions over Europe and Belgium in the 1990s?	
1.2.4 Is it necessary to reduce emissions of O <sub>3</sub> precursors other than VOCs in the future?	
1.2.5 Can we quantify the role of natural and anthropogenic VOCs in the troposphere?	
<b>1.3 Tropospheric aerosols: what are their physico-chemical characteristics, their sources, and their impacts on climate forcing and human health, and is there a change?</b>	<b>45</b>
1.3.1 Introduction	
1.3.2 What are the major aerosol components and can we achieve mass closure?	
1.3.3 Can we quantify the natural and anthropogenic contributions to aerosol formation?	
1.3.4 Can we quantify the aerosol contribution to direct and indirect climate forcing?	
1.3.5 What are the effects of tropospheric aerosols on human health?	
1.3.6 Does and will Belgium meet European standards for particulate matter?	
<b>1.4 How have further Belgian activities contributed to atmospheric research strategies from the regional to the global scale?</b>	<b>52</b>
1.4.1 Introduction	
1.4.2 What has been gained from synergistic exploitation of different observing systems?	
1.4.3 Has atmospheric research benefited from recent progress in modelling studies?	
1.4.4 What original contributions have been made to international atmospheric databases?	
1.4.5 How have laboratory studies contributed to databases relevant to atmospheric research?	
<b>1.5 Concluding remarks</b>	<b>61</b>
<b>2. Climate change</b>	
<b>2.1 How is the earth's climate changing now?</b>	<b>65</b>
2.1.1 Introduction	
2.1.2 Temperature	
2.1.3 Precipitation and atmospheric moisture	
2.1.4 Sea level	
2.1.5 Sea ice	
2.1.6 Tropical regions	
<b>2.2 Is present climate change different from past climate change?</b>	<b>72</b>
2.2.1 Introduction	
2.2.2 Reconstruction of past climates	

2.3	Why has the climate changed in the past?	75
2.3.1	Introduction	
2.3.2	External forcings: astronomical factors, solar variability, and volcanic activity	
2.3.3	Internal processes	
2.4	Why is climate changing now?	78
2.4.1	Are greenhouse gases the real cause of the present climate change?	
2.4.2	Can we explain the 20 <sup>th</sup> century sea level rise?	
2.5	How will climate likely change during the 21 <sup>st</sup> century?	83
2.5.1	Global level	
2.5.2	Regional level	
2.5.3	Hydrological level	
2.6	Are unexpected climate events possible in the longer term?	90
2.6.1	Introduction	
2.6.2	Abrupt changes	
2.7	Will climate change affect atmospheric ozone?	95
2.7.1	Stratosphere	
2.7.2	Troposphere	
2.8	Will the Kyoto Protocol save the climate?	98
2.8.1	Why does the climate need to be saved?	
2.8.2	Inertia between emissions and temperature	
2.8.3	Kyoto and climate stabilisation	
2.9	Where has Belgian research made a difference in the international effort?	103
2.10	Key uncertainties to be addressed	108
<b>3.</b>	<b>The role of the ocean in global change</b>	
3.1	Introduction	111
3.2	What are the physical, chemical, and biological processes responsible for CO <sub>2</sub> fluxes at the atmosphere-ocean interface and within the ocean?	112
3.2.1	What are the carbon species present in the ocean?	
3.2.2	What is the process that drives the exchange of CO <sub>2</sub> between the ocean and the atmosphere?	
3.2.3	How is CO <sub>2</sub> transferred to the deep ocean by a physical process?	
3.2.4	What is the influence of biological activity on vertical carbon fluxes?	
3.2.5	What is the role of biogenic carbonate in the marine carbon cycle?	
3.3	How efficiently does the marine system sequester atmospheric CO <sub>2</sub> ?	114
3.3.1	Introduction	
3.3.2	How is CO <sub>2</sub> distributed in surface water and what are the fluxes at the air-sea interface?	
3.3.3	Is the biological pump an important process in the coastal zone and why?	
3.3.4	What is the contribution of the biological pump in the deep ocean and at the margins?	
3.3.5	What are the CO <sub>2</sub> fluxes linked to the carbonate pump?	
3.3.6	How good are global carbon cycle models at simulating the historical uptake of anthropogenic CO <sub>2</sub> by the ocean?	
3.4	What are the interactions between nutrients and the carbon cycle in the aquatic system?	123
3.4.1	Introduction	
3.4.2	Nitrogen	
3.4.3	Phosphorus	
3.4.4	Silica	
3.4.5	Iron	
3.5	Is the enhancement of natural processes that transfer CO <sub>2</sub> from the atmosphere into the deep ocean a realistic alternative for mitigating the greenhouse effect?	130
3.5.1	Introduction	
3.5.2	How efficiently is fertilisation of the ocean likely to enhance the biological pump?	
3.5.3	Can we envisage injecting pure CO <sub>2</sub> directly into the deep ocean?	
3.6	Key scientific Belgian contributions	133
<b>4.</b>	<b>Global change impact on ecosystems</b>	
4.1	What are the impacts of biodiversity loss in a globally changing world and how can it be stopped?	135
4.1.1	How do ecosystems change when biodiversity declines? Does loss of biodiversity alter the effects of climate change?	
4.1.2	Can management practices counteract loss of plant diversity in agricultural systems?	
4.1.3	Are there instruments for predicting species extinctions and developing conservation policies?	
4.2	What are the interactions between ecosystem functioning and CO <sub>2</sub> and non-CO <sub>2</sub> greenhouse gases?	141
4.2.1	Are Belgian terrestrial ecosystems a carbon sink?	
4.2.2	Do non-CO <sub>2</sub> emissions from agriculture contribute significantly to climate change?	

4.2.3	What is the variability of the terrestrial sink on an interannual timescale?	
4.2.4	What is the ratio of anthropogenically emitted carbon to carbon fixation by European forests?	
4.2.5	Can changes in land use and land management increase carbon sequestration?	
4.2.6	Are Belgian forest ecosystems subjected to soil acidification due to excessive deposition of nitrogen from the atmosphere?	
4.2.7	How will the carbon sink of Belgian forests evolve over the 21 <sup>st</sup> century? What are the impacts of climate and CO <sub>2</sub> in this respect?	
4.3	What is the impact of global change on ecosystem structure, functioning, and distribution (impacts other than carbon sequestration)?	156
4.3.1	Are elevated CO <sub>2</sub> and climate warming changing the productivity of Belgian ecosystems (grasslands)?	
4.3.2	Can we control effects of elevated CO <sub>2</sub> and climate warming on grasslands by adjusting management practices?	
4.3.3	What impacts will climate change have on the distribution of vegetation worldwide? How will these changes interfere with carbon sequestration?	
4.4	What is the impact of global change on water resources?	160
4.4.1	What are the possible impacts on the hydrology of Belgian basins? Are some hydrological basins more sensitive than others?	
4.4.2	Will there be changes in soil moisture, groundwater levels, and stream flow?	
4.4.3	What are the possible impacts of climate change on agricultural systems (crop water deficiencies, irrigation needs, crop growth and yield, field accessibility)?	
4.4.4	How sensitive are diverse fen ecosystems to changes in hydrology coinciding with a changing climate?	
4.5	What drives ecosystem change?	165
4.5.1	Introduction	
4.5.2	Is there a single key factor of change?	
4.5.3	Are social drivers more important than biophysical factors?	
4.6	Reflections, conclusions and outlook	169
<b>Annexes</b>		
Annex 1:	Global change related programmes of BELSPO	172
Annex 2:	BELSPO global change research projects	174
Annex 3:	Research products	178
Annex 4:	From research to policy: examples of programmes and organizations involved	192
Annex 5:	Policies and regulations related to global change issues	195
Annex 6:	Belgian research institutions	198
Annex 7:	Acronyms and abbreviations	200
Annex 8:	Abbreviations for chemical compounds and chemical formulae	206
Annex 9:	Units	207
Annex 10:	Funding sources for global change research used by Belgian researchers	208
Annex 11:	References	209



# Executive Summary

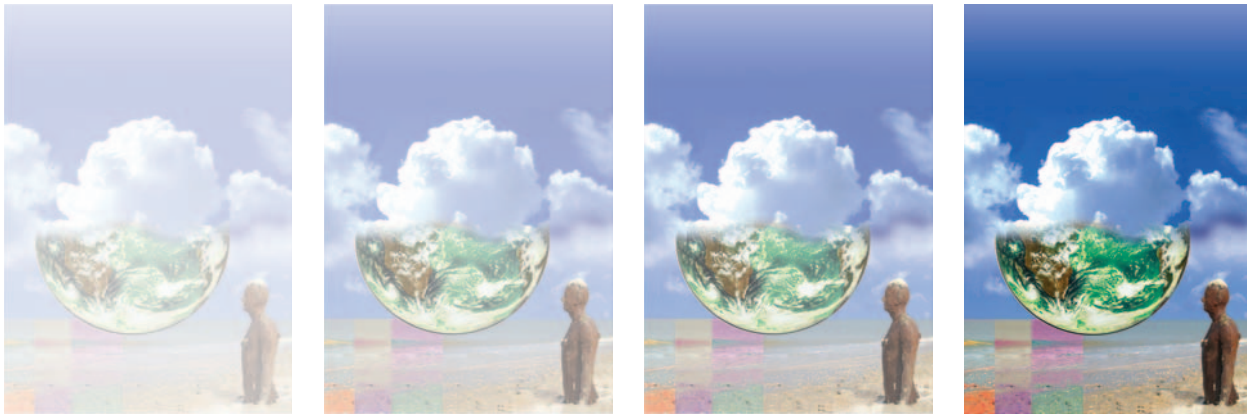

The present Assessment and Integration Report focuses on policy-relevant expertise and findings resulting from BELSPO-funded global change research, and the role of Belgian scientists in international research and policy fora.

The report notably presents striking examples of policy support, policy-relevant questions and answers, and instances of 'sounding the alarm', in which Belgian teams played an important role. It is a concrete attempt to link the relevant Belgian global change research output, products, and expertise to their application in policy preparation, implementation, and monitoring.

The four themes of the report are:

- ✓ Atmospheric composition changes: causes and processes involved
- ✓ Climate change
- ✓ The role of the ocean in global change
- ✓ Global change impact on ecosystems

## **Atmospheric composition changes: causes and processes involved**

Since the middle of the 20<sup>th</sup> century, Belgium has made substantial contributions to atmospheric science research through field, laboratory, and theoretical investigations. When the 'hole' in the stratospheric ozone layer became evident over Antarctica in the early 1980s and concern emerged within the European scientific community as to the weakening of the ozone layer at northern mid- and high latitudes, Belgian groups had the know-how and were readily equipped to tackle this problem. They participated actively in European and international efforts to quantify changes through field observations and identify the causes and processes at work by implementing and operating home-developed atmospheric models. Quasi simultaneously, links between global atmospheric composition changes and climate changes emerged, implying the need of even stronger multidisciplinary coordination at

all levels – from regional to global – for the study of both the troposphere and the stratosphere by means of sophisticated techniques aboard different observation platforms and over extended time periods.

Within this overall evolutionary context, major scientific investigations conducted by Belgian groups dealt with:

- ✓ ***The evolution of total atmospheric ozone and its distribution versus altitude at northern mid-latitudes, in particular above Belgium.*** This research revealed a mean temporal decrease in 'good' ozone in the stratosphere and an increase in 'bad' ozone in the troposphere. With the help of model calculations it was shown that both changes are primarily of anthropogenic origin. Further observations in Uccle (Brussels) showed that observed levels of harmful UV-B irradiance at ground level anti-correlate with levels of stratospheric ozone. Initiatives have been taken to warn the general public about health risks resulting from excessive exposure to the sun in summertime.
- ✓ ***Long-term studies of nitrogen, chlorine, and bromine loadings in the stratosphere, causing most of the erosion of the protective ozone layer.*** Belgian monitoring programmes conducted at four European sites in the framework of the international Network for the Detection of Stratospheric Change (NDSC) have shown that stratospheric chlorine loading above Europe reached a peak at the end of the 1990s, whilst stratospheric bromine loading continued to increase. Model calculations based on decades-long measurements of important source gases (to which Belgium contributed substantially) and on realistic evolutionary scenarios for ozone-depleting halogen compounds (as set out by the

enforced 1987 Montreal Protocol), predict a return of the ozone layer to its pre-ozone-hole state by 2050.

- ✓ ***Quantitative modelling of present and future tropospheric background ozone concentrations and peak events, taking into account observed abundances of key precursors such as Volatile Organic Compounds (VOCs) and nitrogen oxides (NO<sub>x</sub>) and expected changes in their emission.*** Despite recent encouraging signs of reduction of these emissions at northern mid-latitudes (including Europe), resulting from the implementation of directives and strategies such as the Convention on Long-Range Transboundary Air Pollution (CLRTAP) and Clean Air For Europe (CAFE), global precursor scenarios predict that major tropospheric ozone increases will occur in developing countries over the 21<sup>st</sup> century, thus contributing a global positive forcing of the earth's climate system. The influence of Non-methane Volatile Organic Compounds (NVOCs) on tropospheric ozone remains poorly quantified, but related processes are being quantified successfully in Belgian laboratories and implemented into tropospheric modelling codes.
- ✓ ***Monitoring, from aboard satellites, of stratospheric aerosol loading on a quasi-global scale.*** The study of their spatio-temporal distribution between 12- and 35-km altitude has shown that aerosols are among the most varying constituents in the lower stratosphere, capable of exerting negligible to acute regional-scale effects on climate. In particular, major volcanic eruptions, like that of Mount Pinatubo (Philippines) in June 1991, enhance aerosol abundance significantly, worldwide. Belgian scientists were able to show that the aerosol increase

following this event caused temporary depletion of stratospheric ozone above Brussels-Uccle (Belgium) and of nitrogen dioxide over the Jungfrauoch (Switzerland). This is one example of the role of aerosols in stratospheric chemistry. It demonstrates, in addition to direct and indirect impacts of aerosols on climate, the importance of simultaneous long-term monitoring of the particulate and gaseous composition of the stratosphere.

- ✓ ***Consistent observations and chemical and microphysical analyses of tropospheric aerosols, including mass closure determinations.*** These efforts were carried out at various sites, both in Belgium and abroad, primarily within the EUREKA project on the transport and chemical transformation of trace constituents in the troposphere over Europe (EUROTRAC) and within other international projects. It appears that at most near-city, urban background, and kerbside sites, Belgium will not meet European standards for suspended particulate matter levels set for 2010. Road traffic and biomass burning are the major causes of high levels of suspended particulate matter in the troposphere. Based on calculations performed with radiative transfer models, it is now generally agreed that both tropospheric and stratospheric aerosols influence the earth's climate, but their relative impacts remain uncertain. Current levels of suspended particulate matter in ambient air also remain an acute concern from a human health standpoint.
- ✓ ***Sustained efforts to integrate and promote national atmospheric research activities into international systems and programmes.*** To this end, Belgium has contributed significantly to the Integrated Global Observing Strategy (IGOS) through

active participation in international ground-based networks, successive European research campaigns, and numerous projects developed by the international research community under the umbrella of important trans-national research organisations and space agencies. Other important contributions have dealt with the development, calibration, and validation of ground-based, airborne, and space-based sensors of the atmosphere, the aim being to assess their respective qualities and uncertainties and make their results mutually consistent for comparison and complementarity. Important returns for Belgium have been the incorporation of national scientific efforts and findings into European and more global integration strategies. Recognition of Belgian expertise is attested by frequent official invitations to coordinate international cluster-type projects and programmes, to join European and international science panels and advisory groups, steering committees, etc., and to contribute to scientific assessments of worldwide relevance to policy initiatives.

- ✓ ***Continuous laboratory, analytical, and theoretical developments helping to resolve new issues, to improve the quantitative understanding of processes, and to increase confidence in predictive scenarios.*** Related efforts have included developments of instruments and retrieval algorithms, innovative spectroscopic laboratory studies, and kinetic and chemical mechanism calculations, most of them performed as national contributions to international programmes. They have further led to improving and updating fundamental data archives of worldwide relevance, and have helped to reduce uncertainties in model simulations and predictions of long-term

changes in the state of our environment, including atmospheric composition and climate, thus supporting both the Montreal Protocol (1987) and the Kyoto Protocol (1997).

The research results have contributed directly or indirectly (through international research programmes) to the World Meteorological Organization (WMO) Scientific Assessments on Ozone Depletion and to the EUROTRAC-2 Synthesis & Integration Report 'Towards Cleaner Air for Europe - Science, Tools and Application'. Most of the Belgian activities described in Chapter 1 have supported integrated research programmes and directives issued by international coordinating entities such as the European Union (EU), the NDSC, the International Geosphere-Biosphere Programme (IGBP), and the World Climate Research Programme (WCRP), all aiming at better quantification and understanding of global changes, to ensure sustainable development and a safe environment for generations to come.

### **Climate change**

There is no doubt that man's activities have gradually increased the total amount of greenhouse gases in the atmosphere, leading to the prospect that the earth's climate could warm by several degrees Celsius. This would be unprecedented over the past two million years.

Major scientific investigations conducted by Belgian research groups have dealt with:

- ✓ ***Detecting, attributing, and studying the important changes in the global climate system that occurred over the 20<sup>th</sup> century.*** Research groups have been able to quantify (by observation and simulation), e.g., the evolution of the mean air temperature over

the last two centuries, mass changes in the polar ice sheet and the global retreat of glaciers (leading to a significant sea level rise), changes in sea-ice volume, and changes in air and lake temperature in tropical regions. By studying natural changes in the climate system having occurred on time scales of 1,000 to 100,000 years (changes in air temperature, sea level, and land-based ice volume and surface area) as well as the processes having led to these alterations (astronomical factors, solar variability, El Niño Southern Oscillation ENSO,...), the Belgian scientific community has contributed substantially to the crucial detection and attribution issue: evidence for an anthropogenic signal in the climate system. By comparing the evolution of air temperature over the last 150 years as observed and modelled, scientists have determined that most of the warming observed over the last 50 years is attributable to human activities.

- ✓ ***The expected global climate of the 21<sup>st</sup> century under different realistic greenhouse gas emission scenarios.*** In particular, research groups have studied in detail glacier responses to different climate scenarios and the contribution of ice sheet mass changes to sea level changes. Owing to the projected increase in the globally averaged surface temperature, glaciers and ice caps will continue their widespread retreat during the 21<sup>st</sup> century. It has further been found that together, the Greenland and Antarctic ice sheets have contributed so far to a slightly negative change in sea level. On a longer time scale (1,000 years) it has been shown that even with moderate warming the Greenland ice sheet will eventually disappear. Simulations predict a large decrease in sea ice extent during



the third millennium, despite stabilisation of greenhouse gas concentration at its year-2000 value.

- ✓ **Large-scale, high-impact, non-linear, and potentially abrupt events.** Belgian researchers have investigated the potential instability of the Western Antarctic Ice Sheet (which contains enough ice to raise the sea level by 6 m) and have modelled the stability of the thermohaline ocean circulation. These simulations indicate, e.g., that the North Atlantic branch of the circulation system is particularly vulnerable to changes in atmospheric temperature, resulting in a major cooling of the North Atlantic. In addition, biogeochemical surprises could occur. Local destabilisation of gas hydrates, causing abrupt release of large amounts of greenhouse gases into the atmosphere and hence aggravating global warming, has been studied in detail at Lake Baikal (Siberia).
- ✓ **An interesting crossover issue investigated is the effect of climate change on atmospheric (tropospheric and stratospheric) ozone.** An important focus of study is how climate change will affect recovery of the stratospheric ozone layer over time.

The research results have contributed directly or indirectly (by means of international research programmes) to the Assessment Reports of the Intergovernmental Panel on Climate Change (IPCC). The IPCC assesses the available information on the science and impacts of climate change and provides, on request, scientific and technical advice to policymakers (via the Conference of the Parties to the United Nations Framework Convention on Climate Change, UNFCCC). This scientific information is crucial to formulating, on both the regional and global scales, the necessary

adequate and coherent policy measures to tackle the climate change problem (e.g., the Kyoto Protocol).

### **The role of the ocean in global change**

It is presently accepted that about 30% of the anthropogenic CO<sub>2</sub> injected into the atmosphere is transferred to the ocean, where it can be sequestered for up to a thousand years. There are, however, major uncertainties regarding this flux, mainly because little is known about CO<sub>2</sub> transfer at the air-sea interface in the coastal zone, the fate of organic matter produced on the shelf, and the role of the Southern Ocean in the global carbon cycle. Belgian teams have contributed greatly to the study of these three important zones, which are among the priority areas defined by international organisations such as the International Geosphere-Biosphere Programme (IGBP). Their efforts have been widely appreciated by the international scientific community.

The major contributions of Belgian oceanographers to global change studies are:

- ✓ **An estimation of fluxes in various coastal areas in order to reduce uncertainties.** Teams have demonstrated that, even though the coastal area represents only 6% of the total surface of the ocean, air-sea fluxes per unit surface area are one order of magnitude greater than in the open ocean and that uptake of CO<sub>2</sub> by the North Sea and at the North-western Atlantic margin is therefore very significant. In addition, studies carried out in the Southern Ocean allowed better understanding of CO<sub>2</sub> uptake in this high-nutrient, low-chlorophyll area and of its sensitivity to climate change.
- ✓ **The demonstration that organic matter produced on the shelf and exported across the ocean margins can be sequestered for**

**long periods.** Investigations carried out in collaboration with other European teams have demonstrated that a significant part of the organic matter produced on the shelf is exported across the ocean margins and contributes to the so-called biological pump, which transfers carbon from the surface water to the deep water where it can be sequestered for long periods of time. One of the Belgian teams also modelled the large-scale iron fertilization experiment in the Southern Ocean where iron is known to limit the productivity of plankton. It was demonstrated that the additional amount of CO<sub>2</sub> sequestered during the experiment was limited.

- ✓ **Source of nitrogen and phosphorus.** A detailed study of the nutrient cycle has demonstrated that the main source of nitrogen and phosphorus in the coastal zone is the transfer of deep, rich ocean waters onto the shelf. The influence of rivers is less important than expected earlier, except in the river plume of highly disturbed rivers like those discharging into the North Sea. Severe changes in the speciation of plankton have occurred there because of excess nitrogen and phosphorus input and owing to disequilibria with respect to other nutrients such as silica, causing eutrophication of the area and the development of undesirable plankton species.
- ✓ **The role of biogenic calcium carbonate production in the marine carbon cycle.** It was demonstrated that coral reefs generally act as sources of CO<sub>2</sub> for the atmosphere. It was also shown that calcareous skeletons of algae produced in the surface water dissolve rapidly in the water column through CO<sub>2</sub> consumption. The impact of this process on the carbon cycle remains poorly understood.

- ✓ **Development of prognostic models for most of the physical and biogeochemical processes studied.** These models make it possible to predict future changes and the effect of management decisions on the marine ecosystem.

### **Global change impact on ecosystems**

Global change impacts are diverse and often complex. An array of coinciding global changes (rising atmospheric CO<sub>2</sub>, climate-warming, stratospheric ozone depletion, loss of biodiversity, landscape fragmentation, biological invasions, ...) currently affect a series of interrelated processes (productivity, carbon sequestration, water relations, maintenance of biodiversity, ...) across a variety of ecosystems (agricultural, forest, natural, ...). Some processes constitute a global change and an impact at the same time. For example, biodiversity loss is a key component of change across biomes, with repercussions for ecosystem functioning, while it is also an impact of changing patterns in global land use. Impacts on the biosphere may feed back to the factors that cause them. Changes in soil respiration in a warmer climate, for example, can alter the carbon balance of terrestrial ecosystems and reinforce drivers of global warming (elevated CO<sub>2</sub> and other greenhouse gases). Faced with this complexity and multiplicity, Belgian scientists have concentrated on the identification, analysis and forecasting of impacts in many of the aforementioned fields. A series of methods and techniques was developed or implemented, such as experimental simulation of global changes, construction of predictive models, and monitoring. The perspective of this research was both global and local: for example, the study of carbon fluxes in Belgian forests has improved the understanding of the global carbon cycle, but has also clarified the

potential contribution of forest C-sequestration towards meeting standards of the Kyoto Protocol on the Belgian scale. Key findings, knowledge gaps, and tools developed are summarised below.

- ✓ **Belgian agricultural landscapes, half of which consist of grassland, are likely to undergo severe changes over the coming decades.** In a warmer climate, grassland productivity will be enhanced in spring and reduced in summer, which will disturb current pasture usage. Elevated atmospheric CO<sub>2</sub> counteracts the summer loss, but tends to reduce herbage nutrient concentrations.
- ✓ **Apart from being warmer, the future climate will be characterised by more frequent extreme events.** Mitigation of global warming should protect plant diversity by preventing species-rich plant community systems from losing the species most sensitive to such extremes. The effect on species-poor communities should be less pronounced. Future research should give priority to finding ways to make grasslands, and ecosystems in general, more robust. To assist the managers of nature reserves, new tools based on population dynamics have been developed to predict how biodiversity can be optimised by changing ecosystem management.
- ✓ **Models predict significant changes in the world's biome distribution with rising atmospheric CO<sub>2</sub> and global warming.** In particular, there should be substantial reductions in the extent of tundra, and a northward shift in the border between temperate mixed forests and boreal evergreen forests. In Southern Africa, India, Australia, and the Mediterranean,

desertification is expected to expand.

- ✓ **Temperature increase and changing precipitation patterns, and notably decreased rainfall in summer, will affect the hydrological cycle of catchments in our temperate region.** Models predict considerable groundwater deficits in summer, with possible repercussions for drinking-water provision, eutrophication, water quality, aquaculture, etc. Crop water deficiencies will likewise become more frequent and irrigation needs will increase. In wetlands, lowering of the groundwater table in dry summers induces acidification, which enhances phosphorous availability and can alter vegetation composition and plant diversity.
- ✓ **With regard to the fate of the main greenhouse gas CO<sub>2</sub>, models have been developed and data collected that allow quantifying (within wide limits) soil carbon stock patterns and net carbon exchanges by vegetation over the Belgian territory.** The ratio of anthropogenically emitted carbon to carbon fixation by forest vegetation can be calculated for Europe with sufficient accuracy, but terrestrial carbon sinks show very strong inter-annual variability.
- ✓ **Besides CO<sub>2</sub>, various other greenhouse gases such as N<sub>2</sub>O, NO and CH<sub>4</sub> are emitted and taken up by terrestrial ecosystems.** With great uncertainty, their role and impact on Belgian agriculture have been estimated, but results show that the emission factor of N<sub>2</sub>O from Belgian agriculture is above IPCC guidelines. Variable emission and uptake of non-CO<sub>2</sub> greenhouse gases from terrestrial ecosystems is important with respect to



the total greenhouse gas budget when carbon sequestration is considered as a CO<sub>2</sub>-mitigating option.

- ✓ ***Analysis of how ecosystems change when faced with global changes has revealed that change is seldom driven by a single factor.*** Concomitant occurrence of causes is frequent and synergetic factor combinations are even more widespread. Biophysical drivers cannot be studied separately from social drivers, since ecosystem change occurs in a coupled human-environmental system.

# Introduction

## What is Global Change?

---

The term 'Global Change' encompasses various kinds of global issues and interactions related to natural and human-induced changes in the earth's environment. First applied in the 1970s in the social sciences to indicate changes in international social, economic, and political systems, 'Global Change' then became a term used frequently in the natural sciences (1980s) and referring to changes in the earth system. Examples of global environmental change are alterations in atmospheric composition, climate, water resources, land use, land cover, and ecosystems.

The earth's environment is characterised by the global systems of air, water, and land – constituting the physical and chemical environment – and the plants, animals, and humans living therein. The components of this system can also be grouped under the headings Atmosphere, Hydrosphere, Geosphere, Cryosphere, and Biosphere. The constantly evolving interactions between physical, chemical and biological components determine the state or condition of the earth. The complexity of these interactions makes it very difficult to determine causes and effects or to predict future changes. Some changes take place over short time periods (days, months or years), others on time scales of centuries and eons. The rate of some changes seems to be surprisingly high. On a spatial scale, some changes occur over small areas of the earth's surface, while others affect large regions or the whole planet. Some changes are irreversible when a certain threshold is exceeded, this having a negative impact on the carrying capacity of the earth. Other changes may be reversible, but nevertheless give rise to an irreversible impact.

In many instances, a specific change may induce other changes (chain reaction).

Over the last century, human activities have had an increasingly important role in global environmental change. Their impacts on the environment are attributed to an increasing population and an increasing demand for well-being, and in particular to related activities such as industry, agriculture, exploitation of natural resources, and transport. Emissions into the atmosphere from industries, transport, and households can influence air quality and climate. Changes in land use and land cover can disrupt natural ecosystems and biodiversity and affect the chemistry of the atmosphere, hydrosphere, and soils.

In addition to the threat of significant climate change, there is growing concern over the ever-increasing human modification of the global environment and its implications for human well-being. Basic goods and services supplied by the planetary life-support system, such as food, water, air, and an environment conducive to human health, are being affected increasingly by changes in the global environmental system. Droughts cause crop failures, food shortages, malnutrition, and starvation. Persistent drought can turn fertile agricultural land into desert. Shifts in ocean circulation and temperature affect the climate system, the productivity of fisheries, and navigation. Increasing temperatures will affect the melting of polar ice, which in turn will raise the sea level and thus threaten coastal zones. Climate variability may change weather conditions, with all kinds of consequences (e.g., more frequent floods and severe storms, changes in biodiversity).

Global environmental change is a major challenge that humanity faces today. Those who make policy and decisions for our society

need better tools for facing this challenge. Such tools must be developed through improved understanding of the behaviour of the global earth system that defines the environment of our planet and the options available for responding to changes in this complex system.

## **Global Change research**

---

### **Why is research on global change important?**

Global change research provides scientific insight into the functioning of the earth system and the causes and effects of changes in this system. Its aims are to reduce scientific uncertainties, to allow improved impact assessments and risk predictions, to sound the alarm for emerging issues, and to promote the development of monitoring tools and sustainable technologies. Specific research topics addressed in order to assess options for responding to global changes include long-term enhanced greenhouse effects, changes in atmospheric ozone and ultraviolet radiation, natural climate fluctuations, desertification, deforestation, land use and land cover changes, and ecosystems and biodiversity losses.

With an increasing understanding of global change issues, research results provide valuable input into national and international policy, and also into the evaluation of policy decisions. Research is a driving force in the changes of our society, because our future depends on how advances in scientific knowledge and expertise are used. Science supports policymakers in creating new visions and new possibilities for sustainable development and in promoting public debate. Important as they are, scientific expertise and knowledge constitute just one element in the decision-making and policy-preparing process.

### **How is global change research organised?**

Because of its transboundary and complex

nature, global change is a concern that seems to be addressed most effectively through international policies and co-operations. To study global environmental change, its probable consequences, and especially the human dimensions of change, it is necessary to emphasise the complex interactions among the global physical, chemical, biological, and human components, including socio-economic impacts, legal, ethical, and policy issues, and the technological response to change. This requires a multidisciplinary approach.

The scientific community is responding to the challenge of global change through a wide variety of research efforts on the national, regional, and global scales.

### **Worldwide**

The international effort in global change research is organised around four research programmes: the International Geosphere-Biosphere Programme (IGBP), the International Human Dimensions Programme on Global Environmental Change (IHDP), the World Climate Research Programme (WCRP), and the international biodiversity programme DIVERSITAS. These programmes define the international research agenda and aim at synthesising knowledge, but they do not provide funding for research. Individual contributing research projects are funded by international, national and regional agencies around the world. Further information on these programmes can be found at the websites listed in Annexes 4 and 7.

Because of increasing emphasis on broad-scale integration in international earth system science, on changes affecting the system, and on the implications of these changes for global sustainability, the four above-mentioned programmes decided to form the Earth System Science Partnership (ESSP). The goals of this new collaborative platform, established

in 2001, range from finding answers to fundamental questions about the earth system to formulating pro-active measures for making scientifically based contributions to governance for the sustainable management of the global environment. The platform's activities are built around common scientific questions, employ visionary and creative research approaches, and are based on ever-closer collaboration across disciplines, research themes, communities, programmes, nations, and regions. In addition to the four research programmes, the ESSP has identified four cross-cutting research themes requiring development and partnerships across the natural and social sciences: carbon cycle/energy systems, food systems, water resources, and human health.

Another initiative is the International Group of Funding Agencies for Global Change Research (IGFA), a discussion forum for research funding officials from different countries, representatives of the international research programmes, and other leading scientists in the field. Its participants exchange information and identify issues of mutual interest and ways to address these issues through national and co-ordinated international actions. The IGFA fosters the integration and implementation of global change research and its international coordination, with a view to optimising available resources.

## Europe

The environmental topic within European research programmes has evolved from research on environmental protection towards integration of sustainability, then to research in the current Sixth Framework Programme (FP6, 2002-2006). One of the priorities is research on 'Global Change and Ecosystems', which constitutes major support to the EU strategy for Sustainable Development (decided in 2001 at Göteborg and expanded to the international scale at the UN Johannesburg

Summit on Sustainable Development in 2002). 'Global Change and Ecosystems' is intended to strengthen scientific knowledge for the future orientation of Sustainable Development strategy and the EU's Sixth Environment Action Programme (6EAP, 2001-2010).

The European Science Foundation (ESF), with 76 members in 29 countries, promotes the development of European science at the forefront of knowledge by bringing together leading scientists and scholars, as well as research and funding agencies to debate, plan, and implement European research in all fields, including global change. Its first Scientific Forward Look was entitled 'Earth System Science: global problems, global science – Europe's contribution to global change research'. The ESF has taken several initiatives to implement research and networking, one of which is the ESF Collaborative Research Programmes (EUROCORES), designed to bring together national basic research funding agencies to collaborate on preferably multidisciplinary issues of Europe-wide relevance. EuroCLIMATE, for instance, is a EUROCORES programme dealing with palaeoclimate research.

## Belgium

Belgium responded to the IGBP initiative at the end of the 1980s with the launch of its first Global Change programme. The Belgian Federal Science Policy Office (BELSPO) funds global change research mainly via multiannual research programmes (Annex 1), but also in the framework of space activities, support to federal scientific research institutions, and bilateral co-operation agreements. The 1992 United Nations Conference on Environment and Development (UNCED), held in Rio de Janeiro, was a milestone, as it put Sustainable Development high on the political agenda. In 1996, Belgium was among the first countries to establish a research programme on this

topic, entitled 'A Scientific Support Plan for a Sustainable Development Policy' (SPSD). Global change research was an integral part of this programme.

The BELSPO research programmes related to 'Global Change', in particular the SPSP, aim at:

- ✓ consolidating the scientific potential in Belgium;
- ✓ providing scientific support to policy preparation and implementation on the regional, federal, and international scales;
- ✓ stimulating participation of Belgian scientists in international research networks and international assessment and integration efforts;
- ✓ promoting multidisciplinary and networking at project level;
- ✓ integrating and synthesise research results for policy actors and the public at large; and
- ✓ enhancing the dialogue between policy actors and scientists.

Other funding agencies of the Belgian Communities and Regions also support global change research (see Annex 10), not through specific programmes but through direct support to individual projects and institutions.

## **Providing policymakers with results and expertise related to BELSPO projects**

---

### **What types of research outputs are there?**

BELSPO-funded research projects and the scientists involved in them have contributed to the acquisition of knowledge. The scientific results of projects are normally published in peer-reviewed journals and grey literature or integrated into international assessment activities. The projects also provide some

concrete and practical products relevant to the development, implementation, and monitoring of (national and international) policies. Highlights of Belgian contributions are reported in Chapters 1-4. Also generated is policy-relevant expert advice, a form of expertise that Belgian scientists who have been or are still involved in BELSPO projects apply in specific settings, ranging from media communications to active participation in all kinds of councils and committees.

Types of research outputs include: analyses; inventories and surveys; demonstration projects and pilot studies; training products; models (descriptive, predictive, impact); long-term data series; databanks; maps; measuring instruments and calculation methods; standards; methodologies; manuals; indicators; information systems (websites) and discussion fora (e.g., platforms); policy instruments (decision making); and policy recommendations. Further details on policy-relevant products and the use of scientific expertise related to BELSPO global change research activities are listed in Annexes 3 and 4.

Tools developed to support policy actors are, however, not always easily applicable by administrators. Models, for instance, need to be run by specialists unless a specific user interface has been developed, and they are subject to continuous updating as research and conditions evolve. In general, the expertise of scientists remains essential to the proper interpretation and use of research outcomes.

### **What are the transfer mechanisms?**

There is a need for worldwide dialogue between the scientific community and policymakers. It is also necessary to formalise, consolidate, and strengthen initiatives under development and to promote the knowledge base, which is essential to responding effectively and quickly to the great challenges of global change.

Scientific results and expertise become



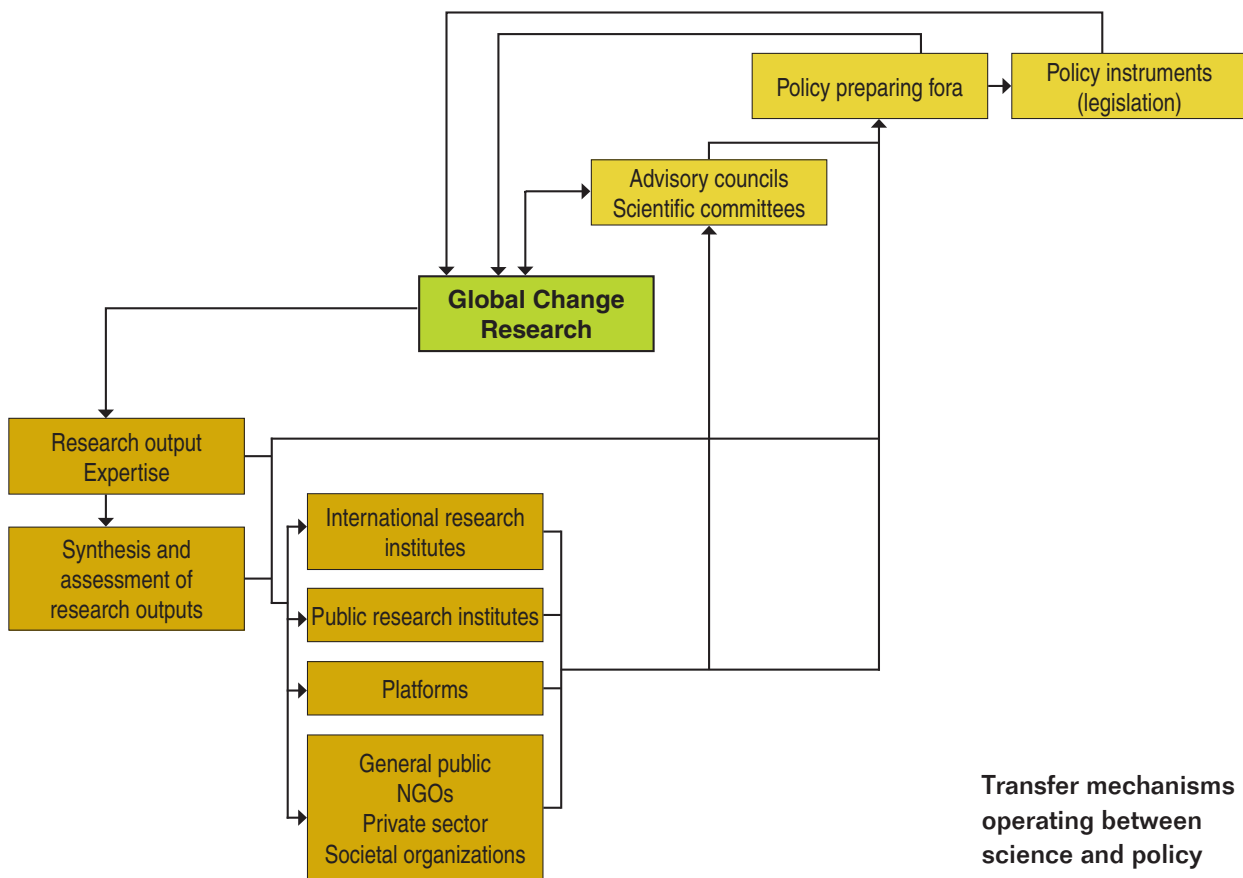

useful information for policy support when they are appropriately integrated into the policy development process via various transfer mechanisms. The figure on this page provides a schematic overview of mechanisms having a potential role to play in the use of global change research for policy development. The figure is based on information provided by Belgian researchers who have been or are still active in BELSPO research programmes.

The figure shows that dissemination of research results and application of scientists' expertise lead to the transfer of research outputs and scientific knowledge to various groups in the public and private domains (who can influence policy actors to prepare legislation and enhance the carrying capacity of society regarding the acceptance and implementation of legislation), and particularly to advisory councils, scientific committees and policy-preparing fora (administrations, working

groups, committees,...). Such fora can include researchers who are appointed because of their personal expertise. Once legislation is produced, scientists can play a role in monitoring the effects of its implementation. Legislation in turn influences the research agendas themselves, through legal obligations or new research orientations. Advisory councils, scientific committees, and policy-preparing fora can also identify further research needs on national and international scales.

Examples of the specific mechanisms of transfer between science and policy in which Belgian scientists are involved include:

### **Integration of individual research results into synthesis and assessment reports.**

Much effort goes into assembling different research output components into broad and more comprehensive pictures and deeper understanding in the context of: (inter)national

research programmes; producing state-of-the-art synthesis reports; and informing policy actors, other scientists, and the public at large. Research results from individual teams receive an added value and become more policy-relevant when aggregated at a higher level within international programmes. At the same time, Belgian researchers involved in these programmes contribute to generating and taking stock of expertise that may be applicable to the Belgian context. Scientific assessments comprise detailed, integrated, state-of-the-art scientific and technical information in a particular area, often accompanied by a synthesis report and/or a specific summary for policymakers. Some assessments are designed specifically to meet the needs of international conventions, e.g., the Millennium Ecosystem Assessment meets the needs of the United Nations conventions on Biodiversity (CBD), Desertification (UNCCD) and Wetlands (Ramsar Convention), the UN Framework Convention on Climate Change (UNFCCC). The climate change assessment issued by the Intergovernmental Panel on Climate Change (IPCC) constituted the basis for developing the UNFCCC and the series of UNEP (United Nations Environment Programme) - WMO (World Meteorological Organization) scientific assessments on ozone depletion led to various amendments and adjustments to the Montreal Protocol. Synthesis and assessment reports also reach international and public research institutes and platforms, as well as the general public, industries, non-governmental organisations (NGOs), and other societal organisations, which can in turn influence policy development at the national and international levels.

#### **Dissemination of research outputs.**

The media is a useful tool to reach the public. In general, scientists make use of general and specialised journals or other communication

media to inform on findings, sound the alarm on upcoming problems, and contribute to awareness building in society. Seminars, workshops, classrooms and Internet are other examples where knowledge and information is disseminated.

#### **Involvement of scientists in international and public research institutes.**

Institutes such as the European 'Joint Research Centre' (JRC) and the 'International Institute for Applied Systems Analysis' (IIASA) are involved in providing assistance, for example to the EC, by integrating research outcomes, developing models, standards, and norms, and responding to direct policy demands. Some Belgian scientists have been active in science policy bridging projects coordinated by these institutes, such as the IIASA study in which a Science and Policy Committee discussed European environmental problems in the next 40 years and the implications of alternative ecologically sustainable development paths. Within the Belgian context, institutes such as the 'Institute for advice and study on sustainable development' (ICEDD) and the 'Flemish institute for technological research' (VITO) respond to specific policy demands.

#### **Involvement of scientists in platforms.**

A new concept introduced by BELSPO is that of thematic platforms where researchers and potential users of research results meet. These platforms promote interactions amongst scientists, between scientists and concerned policymakers, and between scientists and the public. They also advise science policy decision-makers in Belgium (federal and regional) and Europe on specific topics.

**Application of scientific expertise through participation in advisory councils, scientific committees, and policy-preparing fora.**

Scientific support to policy related to global change issues is varied and takes place at different levels: local, regional, national, European, and global. Policy-preparing fora contribute to the drafting of legislation. Annex 5 lists legislation towards which Belgian researchers have actively contributed scientific support. This list also refers to relevant research outputs as described in the thematic Chapters 1–4.

## **Contribution of scientists to shaping (inter)national research agendas.**

As members of scientific committees and expert groups in research organisations and programmes, scientists can influence the setting of research agendas.

## **What is the facilitating role of BELSPO?**

One of BELSPO's tasks is to develop and implement research actions and programmes. The policy-relevant research themes of the programmes are based on international agreements and European directives with which Belgium must comply in the areas concerned and on national initiatives (e.g., in the framework of the governmental declaration, the federal plan for a sustainable development policy, legislation and directives in preparation). Acquiring all necessary scientific knowledge required to provide answers to questions in the field of global change is far beyond the scope of individual regions, countries, and disciplines. BELSPO programmes aim to stimulate contributions to international research efforts and thus to focus on a selection of research themes in which Belgian expertise exists or could be developed. Determining the full programme content is a process of dialogue between BELSPO, the responsible Minister, and the programme steering committees consisting of representatives of the Federal, Regional, and Community administrations.

Calls for research proposals are organised, and proposals undergo peer review by foreign experts. After examination by the programme steering committees, the Minister approves the recommended proposals, which are then managed by BELSPO. Specific information on BELSPO programmes related to global change is presented in Annex 1.

Strategic tools have been introduced into the programmes to increase project effectiveness (e.g., the promotion of multidisciplinary research and project user groups, project clustering). Additional support mechanisms include the organisation of workshops and symposia where scientists and policymakers meet, programme and project information is disseminated, and where press contacts on policy relevant issues take place. Occasionally, specific reports are produced and scientists are invited to take part in policy-preparing fora. Discussion platforms constitute a specific supporting action within the SPSPD. The currently active platforms are 'Biodiversity' and 'Indicators'.

BELSPO programme managers are involved in several policy-preparing fora at the national and international level, where they have the opportunity to exchange information regarding their respective research programmes, notably on relevant research projects and results, and bring back new elements to be included in future research programmes. Examples are given in Annex 4. In addition, administrators participate in the user groups of BELSPO projects, exchange information with scientists, and promote assessment and integration exercises.

## **The Assessment and Integration process**

### **What are the aims of this report?**

The present Assessment and Integration Report represents the state-of-the-art in public-policy-relevant knowledge on global change research funded by the Belgian Federal Science Policy

Office (BELSPO) since 1990 (it also includes some related research as far back as 1985). In this report, 'policy support' refers to the provision of tools (e.g., methods, models, instruments), data, knowledge, and expertise to public administrations at the national and international levels in order to contribute to policy development, implementation, and monitoring and awareness building. The policy domains span sustainable development, natural resource management (conservation and use), and sectoral policy areas such as the environment, agriculture, energy, forestry, water, air, and fisheries.

This Assessment and Integration Report is just one of the initiatives taken towards improved integration of research results into information relevant to policymaking. It focuses in particular on:

- ✓ questions and answers regarding global change topics related to research projects funded by BELSPO within the natural sciences;
- ✓ contextual information to help policymakers understand the complex nature of global change topics in their right proportions;
- ✓ the significance of acquired scientific results for decision-making, detailing scientific outputs in layman's language;
- ✓ highlights of acquired expertise in Belgium;
- ✓ current uncertainties and knowledge gaps and their implications for policymaking at the local, regional, national, European, and global levels;
- ✓ policy-supporting products and services;
- ✓ emerging issues and 'sounding the alarm' topics that anticipate upcoming questions and problems; and
- ✓ transfer mechanisms operating between science and policy on global change related topics.

Apart from policy actors, the report is also of interest to scientists, because it:

- ✓ provides a 'window' to their research results;
- ✓ places their contributions in a common context, e.g., policy relevance;
- ✓ integrates their contributions with those of other Belgian scientists; and
- ✓ fosters understanding, co-operation, synergy, and networking between them.

It thus provides an 'added value' with respect to individual projects. Furthermore, this report gives a compact though incomplete picture of past research activities and state-of-the-art science, which might be used as an input for preparing future research actions, e.g., by providing an opportunity to identify gaps for further research.

### **How was this report prepared?**

The Assessment and Integration Report is the result of a process of analysing and structuring information that encompassed:

- ✓ collecting, classifying, and integrating scientific results;
- ✓ analysing scientific knowledge and creating an inventory of expertise;
- ✓ translating results into stakeholders' language; and
- ✓ enhancing the accessibility of scientific information to (non-)scientists.

BELSPO sometimes produces synthesis reports after 10 years of research in a specific area, mostly written by one or several scientists, based on final project reports, specific symposia, and publications. Preparation of this Assessment and Integration Report required the active involvement of all global change scientists and policy actors who have been or remain active in BELSPO research programmes. Four teams of

science editors from the Belgian global change science community - with broad experience in their domain and in assessment and policy support - were invited to supervise the scientific inputs. A consultant and BELSPO staff guided them. Their combined expertise encompassed the four major themes upon which BELSPO natural science research programmes have focused: atmospheric composition changes, climate change, role of the ocean, and impacts on ecosystems. Based on final project reports and BELSPO publications, the science editors discussed the methodology for producing the report and drafted general questions to structure the report. A questionnaire on science-policy mechanisms, policy support, and Belgian contributions to outstanding scientific findings was distributed to all BELSPO-funded global change research teams. The information collected was analysed and integrated. The above approach was chosen because of:

- ✓ the complexity of 'Global Change' issues (interwovenness);
- ✓ the diversity of scientific disciplines involved;
- ✓ the interaction of different spatial and temporal scales ('glocality');
- ✓ the necessity to promote multidisciplinary, networking, and dialogue between scientists and policymakers;
- ✓ the need to interpret the policy relevance of research results as presented in the final BELSPO project reports; and
- ✓ the opportunity to integrate individual research results into a broader scientific and policy context.

Over the period January-June 2003, the science editors met several times. A general Information Meeting for all interested BELSPO-funded global change scientists and a Residential Workshop in Oostende with a large group of scientists resulted in structuring the report,

formulating clear, striking, and recognisable questions to which answers could be produced (on the basis of BELSPO-funded projects), and selecting illustrations. After external specialists had reviewed the full report, the science editors finalised the drafting during 2004.

In order to keep the process efficient and to minimise the influence of policy actors on the scientific editors' approach, participation of these actors was restricted to those formally linked to BELSPO research via the Programme Steering Committee of the Second Scientific Support Plan for a Sustainable Development Policy (SPSD-II) - part 'Global Change, Ecosystems and Biodiversity' (2000-2006) and the User Groups of the projects. They were invited to participate in the information meeting and workshop and to give their comments on the final draft of the report.

The report focuses primarily on results of BELSPO-funded natural-science research projects related to global change, mainly conducted in the framework of the following research programmes:

- ✓ SPSD II - Global change, Ecosystems and Biodiversity (2001 – 2006).
- ✓ SPSD I - sub programmes: Global change and sustainable development: reducing uncertainties; Sustainable management of the North Sea; Scientific research on the Antarctic Phase IV (1996 - 2000).
- ✓ Impulse Programme Global Change (1990 - 1996).
- ✓ Impulse Programme Marine Science (1992-1996).
- ✓ Belgian Scientific research programme on the Antarctic, Phases I-III (1985 - 1996).
- ✓ EUROTRAC (1989 - 1995).

The present Assessment and Integration Report focuses specifically on studies dealing with the state and processes of the ecosystem earth, in order to highlight the importance and



policy relevance of the role of global change research in Belgium.

The report as a whole, though incomplete, is an illustration of how scientific results can be integrated into policy-relevant information. During the Assessment and Integration process, a 'selection of main questions and sub-questions' was made, clustering scientists around 'hot spots'. The replies to these questions do not provide full answers, but highlight the relevant Belgian contributions provided by the scientists on a voluntary basis. Furthermore, the editorial teams are ultimately responsible for the contents of the Chapters.

Full scientific results are described in the individual final project reports and published in both peer-reviewed scientific journals and 'grey' literature. Most of the final project reports can be downloaded from the BELSPO website or ordered from BELSPO. Some general information on projects and research institutions involved is given in Annexes 2 and 6.

To get an exhaustive, globally assessed picture of global change issues at world level, the reader is invited to consult international scientific assessment reports, examples of which are listed in Annex 4.

In practice it is often difficult, if not impossible, to identify or distinguish ownership of research results as these have frequently been made possible through funding from various sources. Therefore, BELSPO recognises and acknowledges the importance of other funds and/or infrastructural support from the Belgian Communities and Regions, hosting institutions, etc. (see Annex 10).

# 1. Atmospheric composition changes: causes and processes involved



## 1.1 How did stratospheric ozone evolve in the 1990s, will it recover, and how does it affect climate and UV irradiance levels at the surface?

### 1.1.1 Introduction

Natural ozone is a gas present in our atmosphere in very small quantities (see Figure 1.1), averaging about three molecules of ozone for every 10 million molecules of air, but its presence is vital to human well-being. Each ozone molecule contains three atoms of oxygen (O) and is denoted chemically as  $O_3$ . It is mainly found in two regions of the earth's atmosphere. About 90% resides in the stratosphere (located between about 10 and 50 km altitude). It forms the so-called 'ozone layer' which efficiently absorbs biologically harmful solar ultraviolet radiations (called UV-B) that would otherwise reach the ground and threaten life on earth by adversely affecting the health of humans and animals and their environment and food-

supply chains. The remaining 10% is found in the troposphere (extending from sea level to about 10 km altitude). Whereas the specific temperature gradients of these regions preclude continuous exchanges between them, so-called mid-latitude tropopause-folding events occur during which ozone-rich stratospheric air moves down to the troposphere. This can temporarily off-balance the local ozone distribution.

As a result of theoretical and laboratory research initiated in the early 1970s by P. Crutzen, M. Molina, and S. Rowland (who later became the 1995 Chemistry Nobel Prize winners for these efforts), it was discovered that increasing usage and release into the atmosphere of anthropogenic (man-made) chemicals, particularly nitrogen compounds (via fertilisation) and compounds bearing chlorine (such as chlorofluorocarbons, CFCs - the so-called 'Freons' - and hydrochlorofluorocarbons, HCFCs) or bromine (the so-called halons) with large ozone depletion potentials (ODPs) could initiate stratospheric reactions and weaken the

protective ozone layer.

The first signs of stratospheric O<sub>3</sub> destruction were observed over the Antarctic continent in the early 1980s, when the ozone layer showed springtime losses exceeding 30% over an area nearly 150 times that of Belgium and continuing to increase year after year (it was over five times larger by 2000). This springtime depletion was soon called 'the ozone hole', and by the mid-1980s the major causes and processes responsible for it had been identified, namely the dominance of chlorine- and bromine-related catalytic cycles and heterogeneous chemistry on very cold polar stratospheric clouds (PSCs). These form primarily during the polar night periods inside the polar vortex, which is a belt of stratospheric winds circulating counter-clockwise around the pole and preventing substantial exchange of stratospheric air through this vortex barrier. In response to concerns within the scientific community that similar destruction of stratospheric ozone may

occur over the Arctic regions and threaten a much larger population than in the Antarctic, international policymaking organisations and agencies including nearly all nations worldwide adopted the United Nations 'Vienna Convention for the Protection of the Ozone layer' in 1985. This was followed in 1987 by the 'Montreal Protocol on Substances that Deplete the Ozone Layer' (Montreal Protocol), which aims at progressively phasing-out production of all ozone-depleting gases. All major chemical consortia have shown broad compliance with the initial Protocol decisions. Subsequent Amendments and Adjustments resulted from further, more global atmospheric measurements and detailed scientific understanding reported in international assessments to which Belgian scientists contributed numerous original findings. The 1990s saw continued efforts, including synergistic interactions between observations and modelling, to investigate the state of the ozone layer with regard to the evolving

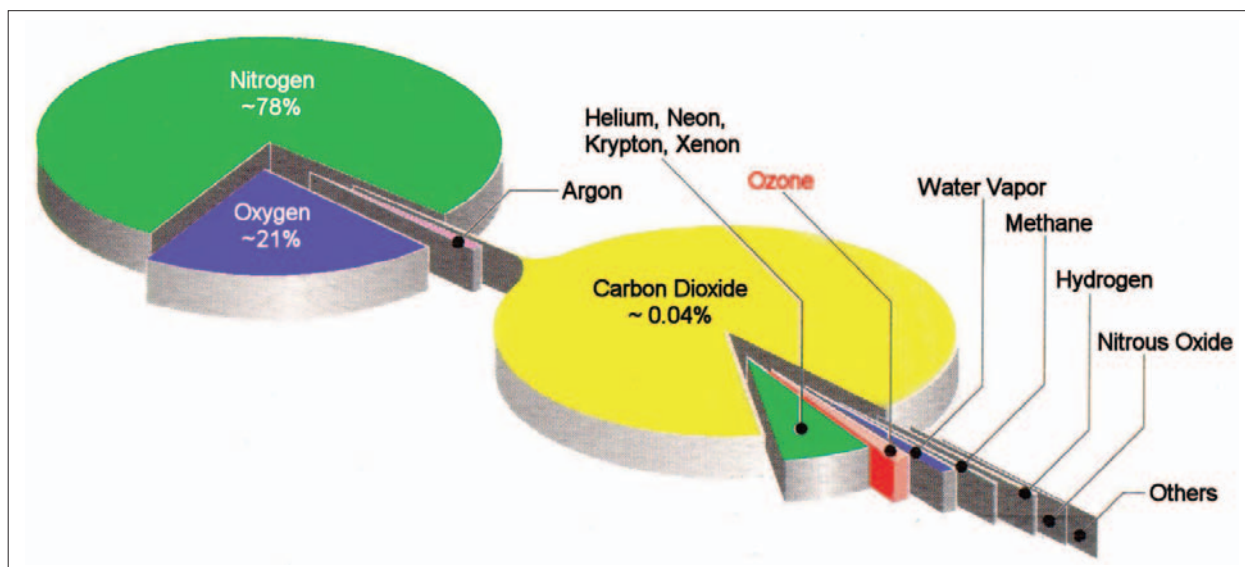

Figure 1.1 - Representation of the relative volume contributions of a series of gases present in the moderately dry earth's atmosphere. The major constituents, nitrogen (N<sub>2</sub>) and oxygen (O<sub>2</sub>), account together for about 99% of the total volume. The remaining 1% includes a number of rare, neutral gases and all other minor and trace constituents. Carbon dioxide (CO<sub>2</sub>) accounts for slightly less than 0.04% by volume and ozone in the stratosphere is another 100 times less abundant. The main environmental preoccupations that have arisen over the past decades (e.g., the ozone layer thinning and climate alterations) thus result from anthropogenic perturbations of a very small fraction of the total atmosphere. (R. Zander, ULg-GIRPAS).



# Atmospheric Composition Changes

Montreal Protocol, as well as perturbations resulting from relevant natural events such as the strong volcanic eruption of the Mount Pinatubo (Philippines) in 1991. Impacts of stratospheric ozone changes on climate, on UV-B radiation levels at the ground and on human health have been studied intensively. Examples of related findings contributed through Belgian research activities over the past 12 years and their relevance to European and international legislations will be highlighted in this section.

## 1.1.2 Do we understand the Arctic $O_3$ depletion processes?

Following observation of the springtime ozone hole over Antarctica, European countries undertook various EC-coordinated campaigns (e.g., European Arctic Stratospheric Ozone Experiment, EASOE; Second European Stratospheric Arctic and Mid-latitude Experiment, SESAME; Third European Stratospheric Experiment on Ozone, THESEO) in order to characterise ozone losses over the Arctic regions and to identify their causes. The relevant Belgian contributions are documented in the EC reports EUR 16986 (1997) and EUR 19867 (2001). They confirm that, as in the southern hemisphere, chlorine-, bromine- and nitrogen-bearing constituents play an important role in the processes causing stratospheric ozone depletion at high and mid-latitudes: ClO (chlorine monoxide), BrO (bromine monoxide) and  $NO_2$  (nitrogen dioxide) are directly involved in catalytic cycles destroying ozone, and OCIO (chlorine dioxide) is a quantitative indicator of the degree of activation (i.e., conversion to  $O_3$ -destroying forms; see also Section 1.1.4) of chlorine 'reservoirs' (non-ozone-destroying forms). OCIO is therefore also an indirect indicator of ozone destruction. In order to test our current understanding of twilight chemistry of these gases (which takes place during sunrise and sunset), ground-based UV-Visible

observations of BrO, OCIO, and  $NO_2$  have been performed since January 1994 at the Harestua station (Norway,  $60^\circ N$ ). These observations have been compared to coupled photochemical box-radiative transfer model (PSC-Box model) calculations initialised by the three-dimensional (3-D) chemical transport model SLIMCAT. Shown in Figure 1.2 are results of the SOLVE (SAGE - Stratospheric Aerosol and Gas Experiment- Ozone Loss Validation Experiment) / THESEO2000 campaign of the winter of 1999/2000, when chlorine activation events (characterised by large OCIO peaks associated with significant BrO enhancements during sunrise and generally very low  $NO_2$  columns) definitely did occur. These observations helped to refine our current understanding of the twilight chemistry of the coupled chlorine, bromine, and

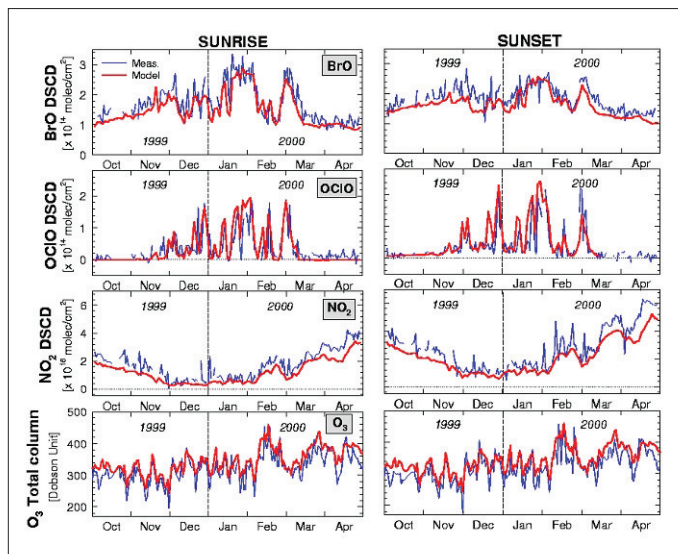

Figure 1.2 - Observed and calculated BrO ( $80-90^\circ$  solar zenith angle,  $sza$ ), OCIO ( $80-92^\circ$   $sza$ ), and  $NO_2$  ( $80-90^\circ$   $sza$ ) differential slant column densities (DSCD), and  $O_3$  total columns in Dobson units, for sunrise (left) and sunset (right) at Harestua (Norway,  $60^\circ N$ ) for the winter 1999/2000. These comparisons show that model calculations reproduce quite well most observed features, thus indicating that the important activation processes involved in ozone depletion at northern latitudes (both inside and outside the vortex) are well implemented in the model algorithms used here. The Dobson unit, DU, is defined in Annex 9. (F. Hendrick, BIRA / IASB).

nitrogen families.

The PSC-Box model developed at BIRA / IASB is essential to the quantitative interpretation of UV-Visible measurements of the photochemically active constituents (OCIO, BrO, NO<sub>2</sub>) involved in O<sub>3</sub> destruction processes.

It should be noted here that the long-term average total ozone depletion over the Arctic region has been statistically significant since the mid-1980s, but the maximum depletion (22% in March 1997) has generally been less severe than over the Antarctic (37% in October 1998 and 1999) and much more variable from year to year (WMO report nr. 47, 2003).

### **1.1.3 How has O<sub>3</sub> changed over highly populated northern mid-latitude regions?**

While stratospheric ozone depletion occurs largely over the Antarctic and Arctic regions during winter/spring, there have also been signs of such depletion at northern mid-latitudes since the mid-1980s. Within this context, the original long-term monitoring activities conducted at IRM / KMI with Dobson and Brewer instruments have shown negative deviations in the total O<sub>3</sub> content over Brussels-Uccle. With respect to the mean columns of 1972 to 1982, the subsequent mean decline until 2001 was found equal to  $-0.27 \pm 0.04$  %/yr (see Figure 1.3). This yearly mean negative trend results primarily from large negative deviations during the winter and spring months. From the unique long-term series of vertical ozone profile measurements by means of balloon soundings over Brussels-Uccle since 1969, it was concluded that these winter-spring column decreases have taken place primarily in the lower stratosphere. In contrast, the homogenised time series of the tropospheric soundings show that there has been an increase at these lower levels (up to more than 1%/yr in the fall) between 1969 and

2001. The long-term trends reported here are consistent with similar investigations performed at other northern hemisphere sites, and are documented in recent international scientific assessments (e.g., WMO reports nr. 44, 1999; and nr. 47, 2003) dealing with ozone changes in the earth's atmosphere.

Besides such long-term variations, changes in total ozone on shorter time scales have also been observed over Brussels-Uccle. In particular, the strong El Chichón (Mexico, April 1982) and Mount Pinatubo (Philippines, June 1991) volcanic eruptions, which injected large amounts of sulphurous aerosols (tiny liquid or solid particles that are suspended in the atmosphere; see also Section 1.3.1) into the stratosphere, led to increased ozone depletion due to enhanced heterogeneous chemistry reactions during the subsequent cold seasons (see Figure 1.3). On an even shorter time scale, day-to-day O<sub>3</sub> column variations also occur over Brussels-Uccle. For instance, particular dynamic conditions in the atmosphere (mostly during late fall) can cause so-called 'ozone mini-holes' for a couple of days, with the ozone content dropping by up to 30% below the long-term mean. These mini-holes are of purely dynamic origin and do not result from anthropogenically induced ozone depletion. Similar long- and short-term variations in the total ozone columns have equally been observed by Belgian scientists at other northern mid-latitude stations such as Harestua (Norway), the Jungfrauoch (Switzerland), and Haute Provence (France) (see Table 1.1), all of which are affiliated with the Network for the Detection of Stratospheric Change (NDSC)

All these rapid variations in both ozone columns and vertical profiles make it necessary to continue related observations over long periods in order to better quantify their secular trends and to establish related climatologies (i.e., statistically significant average as well as extreme situations over time-frames from

# Atmospheric Composition Changes

days to seasons) over populated northern mid-latitudes which encompass Belgium.

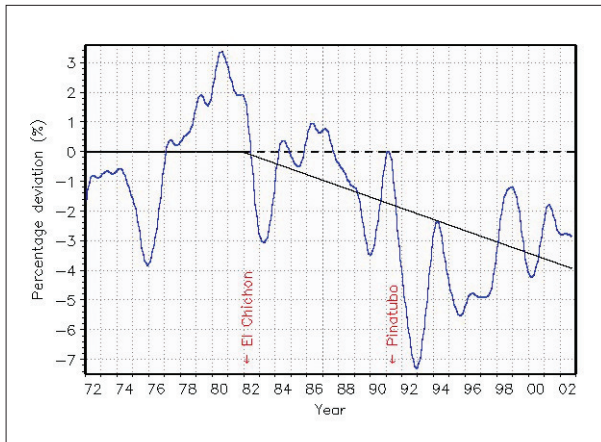

Figure 1.3 - Deviation in percentage of the total ozone column (measured with a Dobson spectrophotometer) at Brussels-Uccle (Belgium) from the mean of the first ten years (1972-1982) of observations. The total ozone column has decreased by 4% over the past 2 decades. The data shown have been corrected for the influence of sulphur dioxide ( $\text{SO}_2$ ) present in the boundary layer in the 1970s due to coal combustion. (H. De Backer, IRM / KMI).

## 1.1.4 What is the impact of stratospheric aerosols on $\text{O}_3$ depletion?

### The importance of stratospheric aerosols

The radiative budget of the earth (and thus its climate) is strongly controlled by minor and trace gases such as water vapour ( $\text{H}_2\text{O}$ ), carbon dioxide ( $\text{CO}_2$ ), methane ( $\text{CH}_4$ ), ozone ( $\text{O}_3$ ), etc. (see Figure 1.1), which absorb and reradiate incoming solar and outgoing ground radiation. Besides these minor constituents, the middle atmosphere can host populations of microscopic particles, called stratospheric aerosols, concentrated primarily a few km above the tropopause. Actually, these are the most varying atmospheric compounds in the lower stratosphere over long time periods, and their climatic impact can range from negligible to acute. It is now accepted that they mainly consist of sub-micrometric droplets containing a mixture of water and sulphuric acid ( $\text{H}_2\text{SO}_4$ ). The background aerosol loading, historically called

the Junge layer, can be enhanced significantly following strong volcanic eruptions which inject large amounts of sulphurous compounds directly into the stratosphere.

Over the last 10 years, Belgian scientists have unveiled interesting characteristics of the spatio-temporal behaviour of stratospheric aerosols. In particular, they were given the exceptional opportunity to observe the aerosol loading resulting from the intensive Mount Pinatubo eruption in June 1991. An Occultation Radiometer (ORA), built at BIRA / IASB and operated aboard the EURECA (European Retrieval Carrier) satellite, measured about 7,000 sunsets and sunrises through the earth's atmosphere. A major scientific outcome from this experiment was the determination of the evolution of the aerosol extinction coefficient profile between 12 and 35 km altitude. Special methods were further developed to optically 'invert' the aerosol extinction coefficient, i.e. to derive total particle number density, mode radius, and distribution width. These algorithms were applied to the ORA data and to data provided by the SAGE-II experiment over a 17-year period (see Figure 1.4). An extended aerosol climatology has been built that can be used in models considering heterogeneous

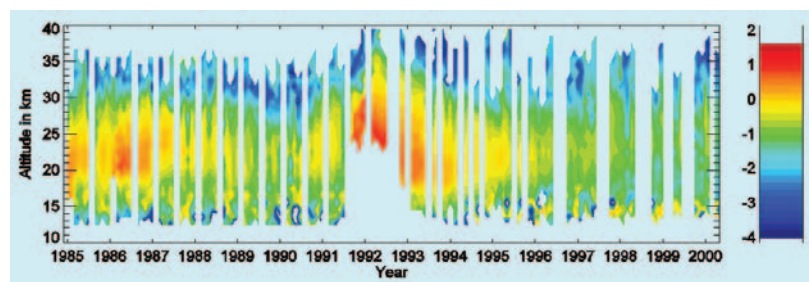

Figure 1.4 - Representation of the temporal evolution of the zonal mean value of the aerosol total number density  $N$  (expressed in  $\text{Log}_{10}(N/\text{cm}^3)$ ) in the latitude band  $0-10^\circ\text{N}$ , as derived from SAGE-II (Stratospheric Aerosol and Gas Experiment) solar extinction data. The aerosol increase observed in 1992-1993 results from the strong Mount Pinatubo (Philippines) volcanic eruption in June 1991. (C. Bingen, BIRA / IASB).

chemistry as well as in radiative transfer algorithms. It should be noted that the spectral properties of stratospheric aerosols have a direct impact on the accuracy of long-term ozone trend measurements by remote sensing techniques from space.

### ***The impact of aerosols on O<sub>3</sub> and NO<sub>2</sub> depletion***

Ozone destruction processes in the lower stratosphere are not limited to the so-called 'catalytic destruction cycles', which are reactions involving chemical species like Cl (chlorine), Br (bromine), NO (nitric oxide), and H (hydrogen). The discovery of the dramatic springtime depletion of ozone over Antarctica has provided evidence for additional destruction processes involving so-called heterogeneous reactions at the surface of particulate matter: gaseous components of the stratosphere that are otherwise inactive in ozone depletion (the so-called reservoirs) interact at the surfaces of these particles to form active chemical compounds that favour O<sub>3</sub> destruction. In the polar regions, the particles responsible are the PSCs. They appear under extremely cold temperatures (below about -78°C) inside the polar vortex during the polar winter night. The chemical compounds formed at the surface of these cloud particles get activated to O<sub>3</sub>-depleting gases like ClO and BrO, when solar light reappears in the spring (see also Section 1.1.2).

Some heterogeneous reactions, however, do not require such cold conditions to occur, so that lower stratospheric aerosol particles at any latitude provide surfaces on which alternative heterogeneous reactions can take place. These can convert NO<sub>2</sub> to the nitric acid (HNO<sub>3</sub>) reservoir, thereby removing active NO and NO<sub>2</sub> (denitrification) from the atmosphere. Consequently, less NO<sub>2</sub> is available to bind the active Cl and Br atoms into their corresponding

reservoirs chlorine nitrate (ClONO<sub>2</sub>) and bromine nitrate (BrONO<sub>2</sub>), thus enhancing the destructive effect of Cl and Br upon ozone.

Major volcanic eruptions like those of El Chichón (April 1982) and Mount Pinatubo (June 1991) inject volcanic aerosols into the stratosphere up to altitudes exceeding 30 km (see Figure 1.4). Because of atmospheric transport, these aerosols spread out globally within a few months. Such dramatic aerosol load increases in the stratosphere significantly enhance the impact of heterogeneous O<sub>3</sub> destruction processes.

The post-El Chichón and post-Mount Pinatubo O<sub>3</sub> depletions were clearly observed in the long-time series of O<sub>3</sub> measurements made in Brussels-Uccle (see Figure 1.3), while the depletion and subsequent recovery of NO<sub>2</sub> that followed the Mount Pinatubo eruption was investigated quantitatively using time series of NO<sub>2</sub> total columns measured above the Jungfrauoch in Switzerland (see Figure 1.5). There, Belgian atmospheric research activities have been conducted quasi-continuously by remote sensing techniques using high-resolution Fourier Transform Infrared (FTIR) solar spectrometry since the early 1980s and UV-Visible spectroscopic methods since 1990 (see Table 1.1). While infrared solar observations are carried out during clear sky days only, UV-Visible observations are carried out at morning and evening twilight, independently of weather conditions. The combination of both NO<sub>2</sub> time series (the longer series of infrared data and the more frequently sampled series of UV-Visible data) used together with a simple model for diurnal NO<sub>2</sub> variation, provided a quantitative evaluation of the removal of NO<sub>2</sub> from the stratosphere owing to the enhanced aerosol load after the Mount Pinatubo eruption. The reduction of NO<sub>2</sub> was evaluated in terms of monthly mean percentage differences relative to a pre-Mount Pinatubo climatology based on

# Atmospheric Composition Changes

the 1988 to mid-1991 infrared data. The largest reduction in  $\text{NO}_2$ , by 45%, was observed during the winter of 1991-1992. Afterwards,  $\text{NO}_2$  gradually recovered, initially quite fast (50% less reduction after about 6 months), then much more slowly until full recovery in early 1995. It should be noted here that a long-term rate of increase equal to  $+(0.6 \pm 0.2)\%/yr$  has been found for the  $\text{NO}_2$  column abundance above the Jungfraujoch, based on the entire 1985-2002 database: this is about twice the trend observed for nitrous oxide ( $\text{N}_2\text{O}$ ), the main source of stratospheric  $\text{NO}_2$ . Model calculations have shown that reconciliation between these two rates of change can be explained only by assuming a

20%-per-decade decrease in aerosol surface area. This is another feedback manifestation of aerosols upon stratospheric chemistry changes. It points to the importance of long-term aerosol monitoring in the stratosphere.

Similar observations have been made at other northern and southern mid-latitude stations, confirming the role of stratospheric aerosols in  $\text{O}_3$  depletion and the temporal evolution of  $\text{NO}_2$ . The efficiency of heterogeneous reaction processes is further reinforced, because aerosols induce a cooling of the lower stratosphere which also impacts climate.

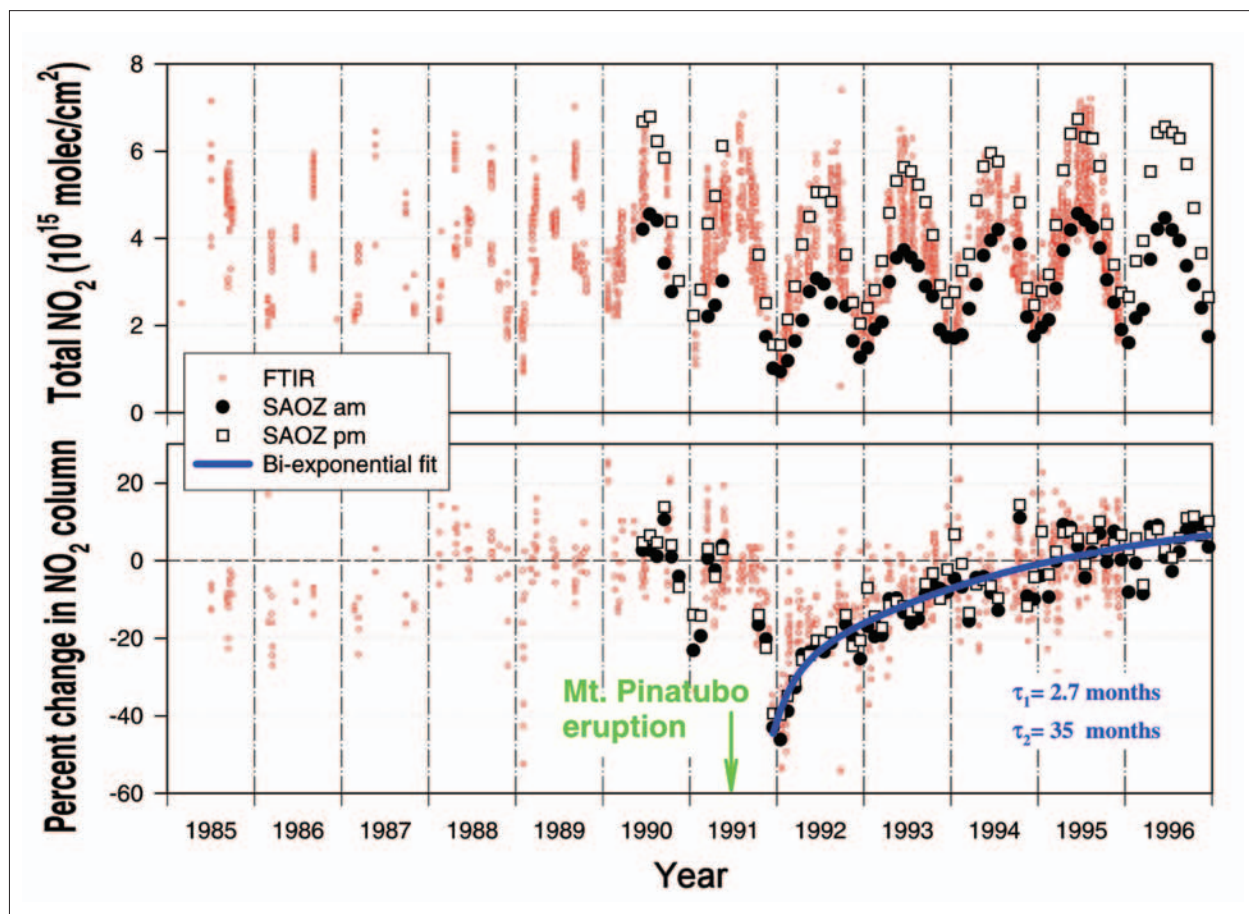

Figure 1.5 - Total  $\text{NO}_2$  reduction at the Jungfraujoch (Switzerland) after the Mt. Pinatubo (Philippines) eruption of June 1991. The top frame shows a superposition of infrared (FTIR, Fourier Transform Infrared; small red circles) and UV-Visible (filled circles and open squares) time series of  $\text{NO}_2$  columns above the Jungfraujoch. The bottom frame shows the percentage monthly mean vertical  $\text{NO}_2$  column reductions observed at the Jungfraujoch by both instruments. The UV-Visible data are monthly means for morning (am) and evening (pm) vertical column amounts; the infrared data are daily mean values. (M. De Mazière, BIRA / IASB).

### 1.1.5 What is the impact of ozone layer depletion on climate and UV radiation at ground level?

In recent millennia, the planet earth has experienced a comfortable and relatively stable climate, favourable to maintaining various forms of life (including mankind). The reason has been the unique (among all planets of the solar system) delicate mixture and vertical distribution of gases such as O<sub>2</sub>, N<sub>2</sub>, H<sub>2</sub>O, CO<sub>2</sub>, CH<sub>4</sub>, N<sub>2</sub>O and O<sub>3</sub> in the atmosphere (see Figure 1.1), whose combined absorption characteristics provide a balance between the incoming solar energy (mainly visible light) and the infrared radiation emitted by the earth surface. The last among the constituents mentioned, ozone, is an important greenhouse gas, owing to strong absorption in the infrared. Its stratospheric layer further absorbs solar UV radiations harmful to life on earth.

The observed mean global depletion of stratospheric ozone since the late 1970s (primarily due to large releases of human-produced gases containing chlorine and bromine) lets more earth-emitted infrared radiation escape to space, thus causing a negative radiative forcing of  $-(0.15 \pm 0.1) \text{ W/m}^2$ . This results in a cooling at the surface (see Figure 1.20). Yet continued compliance with the enforced Montreal Protocol, which ultimately will ban all ozone-depleting halogenated source gases, should return this forcing to nearly zero around the middle of the 21<sup>st</sup> century. Simultaneously, these source gases, most of which have strong (and long-lasting, owing to their long lifetimes) global warming potentials (GWPs, see also Section 1.4.5), will be progressively eliminated from the atmosphere, including the troposphere. This will produce a negative forcing, leading to a relative surface cooling.

Because solar UV-B (280-315 nm) and, to a much lesser extent, UV-A (315-400 nm) radiations are strongly absorbed by stratospheric

ozone, the global climatology of UV irradiance at the earth's surface is affected by changes in the amount of ozone. In turn, these wavelength bands are responsible for many photoreactions in biological systems (UNEP Assessment on Environmental Effects of Ozone Depletion, 1998). The biological processes involved are characterised by a specific 'action spectrum'. Most have a maximum at wavelengths shorter than 300 nm or even below 280 nm (UV-C). They decrease sharply - by several orders of magnitude - in the UV-B region, where the UV irradiance itself increases steeply with wavelength. The proper combination of the biological action spectrum with the UV solar irradiance at the earth's surface gives the instantaneous biological dose rate for each specific biological effect, e.g., skin cancer, eye cataract; and alteration of the immune system, leading to skin effects such as sunburn and photo-ageing.

From the well-known absorption by ozone of sunlight in the UV-B spectral region, it follows that the UV-B irradiance (direct and diffuse components) at the earth's surface should increase as the total amount of ozone decreases. This anti-correlation has been demonstrated (see Figure 1.6) using data acquired since 1993 with an automatic system operated in Brussels-Uccle.

As agreed by an international research consortium which involved over a dozen European countries (including Belgium, and operating within the frame of the EC-COST713 project 'UV-Forecasting'), a standardised UV index (UVI) based on the action spectrum of erythema on human skin has been adopted to inform the general public about the danger of UV radiation. Based on a radiative transfer model, predictions of this index during the critical, high sunny period of the year are produced for Belgium. An ozone forecast is used as input to the model, based on meteorological

# Atmospheric Composition Changes

fields from the European Centre for Medium-Range Weather Forecasts (ECMWF) and ozone observations in Brussels-Uccle. The method has been validated by comparing model results with observations. Along with weather forecasts, these UVI predictions are disseminated by different Belgian media.

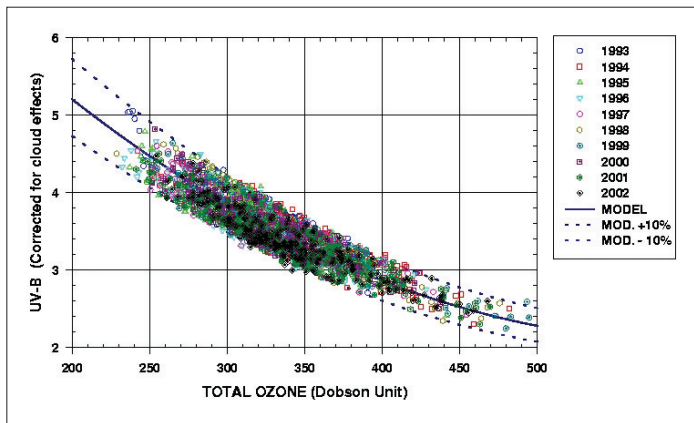

Figure 1.6 - The inverse relationship between the total ozone column and the UV-B ground irradiation as observed in Brussels-Uccle (Belgium) from 1993 to 2002 and under solar zenith angles between 60 and 65 degrees. (H. De Backer, IRM / KMI).

## 1.1.6 Is stratospheric ozone layer depletion under control and when will it recover?

Implementation of the Montreal Protocol (1987) has meant the progressive phase-out of the production of all anthropogenic substances that deplete the ozone layer. It started with the most destructive forms, taking into account not only their ODPs, but also their quantitative production levels, their delayed release into the atmosphere, and their tropospheric lifetimes. Consequently, the main actions first concerned the phase-out of CFC-11 and CFC-12, the two most important Cl-bearing source gases, followed by reductions of other CFCs, such as methyl chloroform ( $\text{CH}_3\text{CCl}_3$ ), carbon tetrachloride ( $\text{CCl}_4$ ), and the essential Br-containing compounds (halons). By the end of 1995, none of these constituents was allowed to be further produced. As a result, the total global

accumulation of anthropogenic chlorine in the atmosphere began to slow down, then stabilise, and even decrease in recent years. This evolution was first noticed in the troposphere (maximum reached in 1992-1994), but it has now propagated to the stratosphere, stabilisation having been observed there around 1996-1998. Important related Belgian contributions are reported in the WMO report nr. 47 (2003). They are based on long-term observations at the Jungfraujoch of total column abundances of hydrogen chloride (HCl) and chlorine nitrate ( $\text{ClONO}_2$ ) (see Figure 1.7).

As of 2001, and despite the phasing-out of halon production by 1994, total anthropogenic bromine has continued to increase consistently

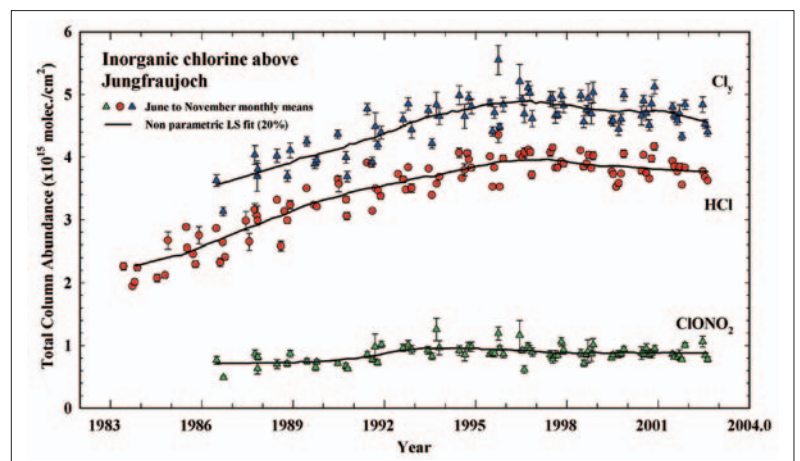

Figure 1.7 - Time series of monthly mean total vertical column abundances of HCl (hydrogen chloride) and  $\text{ClONO}_2$  (chlorine nitrate) derived from infrared solar observations at the Jungfraujoch (Switzerland) from 1983 to 2002. Only June-to-November data have been used here, to avoid significant variability during the winter-spring period. Total inorganic chlorine ( $\text{Cl}_y$ ), which is the sum of the HCl and  $\text{ClONO}_2$  columns, is an excellent surrogate of the total inorganic chlorine loading in the stratosphere. The continuous lines represent the mean temporal trends of the various data sets. These evolutions provide robust evidence that total inorganic chlorine in the unperturbed stratosphere has stabilised recently, in response to the production regulations on chlorine-bearing substances with large ODPs (Ozone Depletion Potentials) outlined in the amended Montreal Protocol. (E. Mahieu, ULg-GIRPAS).

in the troposphere and stratosphere. This results from the considerable banking of these compounds in developed countries and from their further use as fire fighting agents, but also from some authorised production and consumption in developing countries. Belgian scientists have been deeply involved in atmospheric bromine investigations through ground-based UV-Visible observations of stratospheric bromine monoxide (BrO) in Harestua, Norway, since 1994 (see Figure 1.8).

While some gases such as halons and HCFCs will still be increasing in the atmosphere

for some years, model calculations predict that full future compliance with the current Montreal Protocol will lead to a slow decrease in the total abundance of ozone-depleting substances in the atmosphere and, by the middle of this century, fall back to values that prevailed prior to the formation of the Antarctic ozone hole in the early 1980s. Consequently, the global amount of stratospheric ozone is predicted to progressively recover over the next 50 years or so, despite differences in the rates of recovery found by various models. Such model calculations are based on scenarios defined in the IPCC (Intergovernmental Panel on Climate Change) 2001 report, but factors like cooling of the lower stratosphere due to CO<sub>2</sub> increases, changes in atmospheric circulation and in upper troposphere/lower stratosphere exchanges, etc., remain poorly known and are responsible for the predicted recovery uncertainties.

All these trends in the stratosphere will of course need verification based on regular field measurements such as those mentioned in previous sections.

## 1.2 Can we quantify the evolution of the tropospheric ozone content and the related roles of VOC and nitrogen emissions?

### 1.2.1 Introduction

The formation of photochemical ozone in the troposphere is a result of sunlight-initiated oxidation of volatile organic compounds (VOCs, e.g., alkenes, pinenes, propenes) in the presence of nitrogen oxides (NO<sub>x</sub> = NO + NO<sub>2</sub>). These precursors of tropospheric ozone are mainly emitted by anthropogenic sources (transport and industrial activities). Natural sources of VOCs and NO<sub>x</sub> can contribute considerably as well. Tropospheric ozone formation is driven by photochemically initiated reactions and is correlated with air temperature,

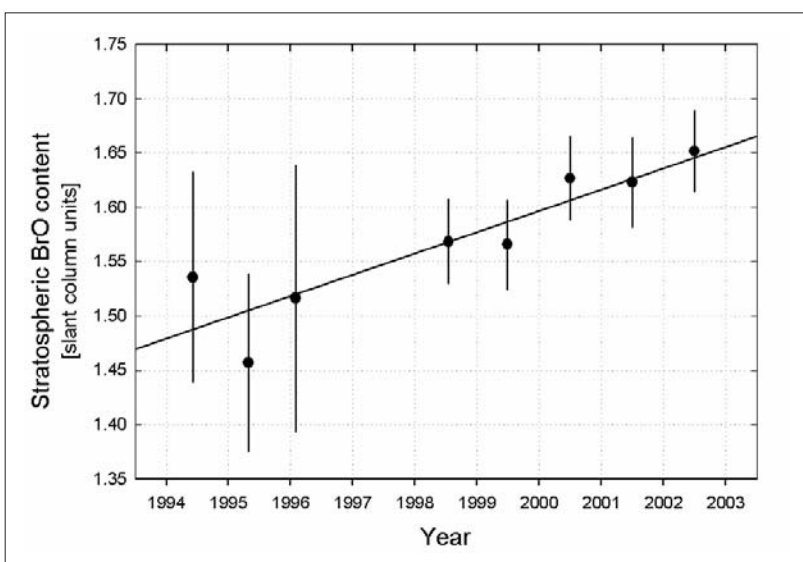

Figure 1.8 – Evolution of the stratospheric BrO content above Harestua (60°N, Norway). Bromine monoxide (BrO) is the most abundant inorganic brominated gas during daylight and is, therefore, a good indicator of the total amount of inorganic bromine present in the stratosphere. Displayed here are the yearly averaged slant columns of BrO measured since 1994 and their associated uncertainties. The BrO slant column is a direct product of the UV-Visible technique; it is proportional to the stratospheric BrO content. A linear fit to the data (represented by the straight solid line) reveals an increase of about 15% in the stratospheric BrO content over the period 1994–2002. This increase is consistent with the recent years' reported rates of change in anthropogenic bromine source gases at ground level, and with recently published inorganic bromine measurements from stratospheric balloons (e.g., see WMO report nr. 47, 2003). (M. Van Roozendaal, BIRA / IASB).



# Atmospheric Composition Changes

so that elevated ozone levels are typically found under meteorological situations with clear skies and high temperatures, thus predominantly during summertime. Figure 1.9 schematises tropospheric  $O_3$  chemistry.

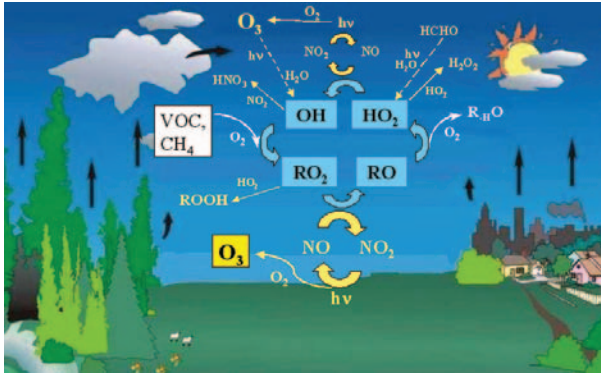

Figure 1.9 - General scheme of ozone formation and oxidation of volatile organic compounds (VOCs) in the troposphere. (J.-F. Muller, BIRA / IASB and J. Peeters, KULeuven-PAC).

Tropospheric ozone has significant effects on mankind and our environment. Through its oxidation capacity, ozone affects lung functions, particularly among children and asthmatics. Exposure to ozone also induces damage to agricultural crops, terrestrial and aquatic ecosystems, and materials such as rubber and paints.

Tropospheric ozone is also a greenhouse gas. It influences, to a large extent, the concentrations of other greenhouse gases in the troposphere. It therefore contributes significantly to climate change. Recorded observations of mean surface ozone concentrations in Western Europe show an increasing trend since the 19th century (see Figure 1.10).

Concern about the damaging effects of tropospheric ozone is shared at various policy levels. At European level, long-term objectives for the reduction of ozone concentrations have been defined in the EC Air Quality Framework Directive (Council Directive 96/62/EC, 1996). According to its Third Daughter Directive on Ozone (Council Directive 2002/3/EC, 2002), the

target values should be attained in the member states by the year 2010. In order to reach these objectives, most of the member states will have to reduce drastically the emissions of pollutants responsible for ozone formation, i.e., VOCs and  $NO_x$ . The emission reductions for 2010 are prescribed by means of the 1999 Protocol to Abate Acidification, Eutrophication and Ground-level Ozone ('Multi-effect Protocol' or 'Göteborg Protocol'), under the United Nations Economic Commission for Europe's (UNECE's) Convention of Long-Range Transboundary Air Pollution (CLRTAP) and the EC Directive on National Emissions Ceilings (NEC, 2001/81/EC). Another important European initiative is the Clean Air For Europe (CAFE) programme (2001-2005), aiming to develop a long-term strategic and integrated policy to protect against the effects of air pollution on human health and the environment. In Belgium, federal and regional

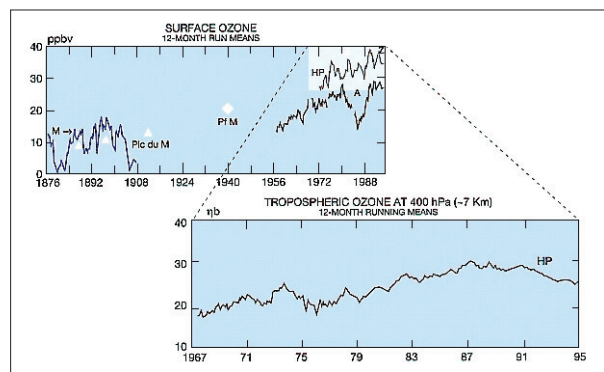

Figure 1.10 - Ozone concentrations in Western Europe since the 19<sup>th</sup> century. As demonstrated by the measurements shown in the upper frame, surface ozone concentrations have more than doubled in Western Europe since the 19<sup>th</sup> century. Century-old ozone observations in Montsouris (M), near Paris, and at Pic du Midi, in the French Pyrenees, are contrasted here with more recent measurements performed at several Western European sites (HP: Hohenpeissenberg; A: Arkona, both in Germany). Evidence of recent large ozone increases in the middle troposphere (at about 7 km altitude) is shown from ozone soundings at Hohenpeissenberg, in the lower panel of the figure. (WMO report nr. 44, 1999; C. Mensink, VITO-TAP).

plans to control acidification and tropospheric ozone also address these policy issues.

### 1.2.2 How is the background tropospheric O<sub>3</sub> changing, does it affect climate, and how will it evolve in the future?

Man-made emissions of nitrogen oxides, carbon monoxide, and hydrocarbons have been responsible for an estimated 36% increase in the globally averaged abundance of tropospheric ozone since the pre-industrial era (IPCC Third Assessment Report, IPCC TAR, 2001). Figure 1.11 illustrates some recent increases in surface ozone in the northern hemisphere. The corresponding model-calculated impact on climate is a positive radiative forcing (surface warming) of  $(0.35 \pm 0.15) \text{ W/m}^2$ , making tropospheric ozone the most important greenhouse gas after H<sub>2</sub>O, CO<sub>2</sub>, and CH<sub>4</sub>. As shown in Figure 1.20, this amounts to about 25% of the radiative forcing ( $1.46 \text{ W/m}^2$ ) due to the increase in CO<sub>2</sub> over the same period, and is further commensurate with the forcing of all anthropogenic halocarbons actually present in the atmosphere.

While there is a competing effect upon climate of decreasing stratospheric and increasing tropospheric ozone, the former is considerably weaker than the latter. Yet, controlling, then progressively eliminating the causes of both changes could significantly reduce the atmospheric gaseous forcing (by up to 20%). This is the aim of the current Montreal Protocol and of initiatives such as CLRTAP and CAFE.

Further details on ozone-climate interactions can be found in the WMO reports nr. 44 (1999) and nr. 47 (2003) and in the EC reports nr. EUR 16986 (1999) and nr. EUR 19867 (2001).

Based on the above observations, it has further been established that the increases in tropospheric ozone concentrations over Europe

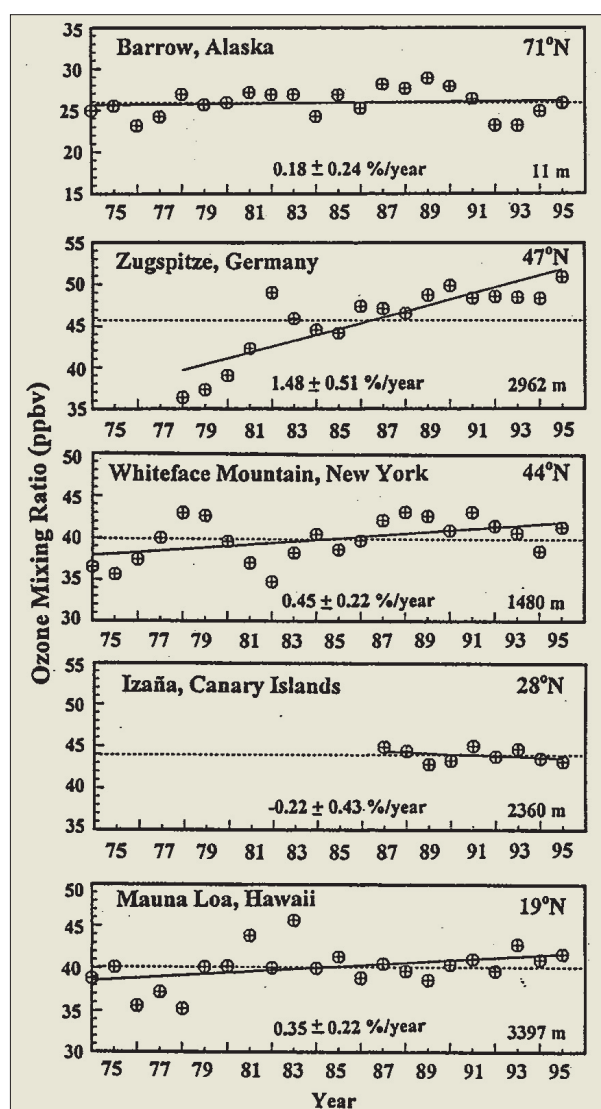

Figure 1.11 - Recent evolution (1975-1995) in annually averaged surface ozone concentrations at various sites in the northern hemisphere. Measurements have shown large increases in background tropospheric ozone over many parts of the world in the 20<sup>th</sup> century. (WMO report nr. 44, 1999).

and the United States have slowed since the late 1980s, reflecting the pollution control measures in these regions of the world where VOC and, in some regions, NO<sub>x</sub> emissions have been successfully reduced (WMO report nr. 44, 1999). Despite these encouraging signs, it cannot be concluded that tropospheric ozone, on a global scale, will decline in the future. Indeed, according to current emission scenarios

## Atmospheric Composition Changes

(see Figures 1.12 and 1.13), large emission increases are expected to occur in developing countries during the 21<sup>st</sup> century. These new emissions have the potential to cause large ozone increases because they mostly take place in tropical (i.e., sunny and warm) areas favouring ozone chemical production when NO<sub>x</sub> emissions are increased.

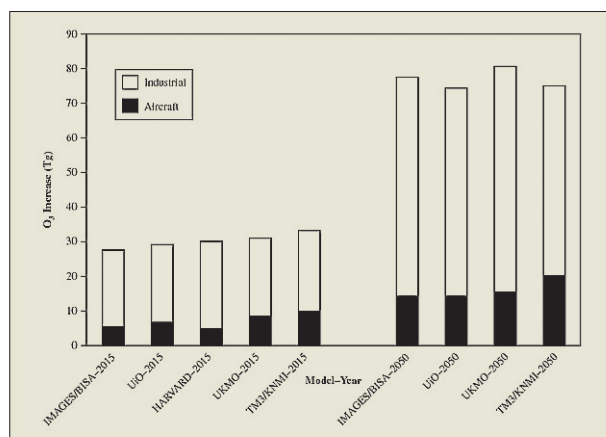

Figure 1.12 - Predicted increase in the total amount of tropospheric ozone on a global scale, due to aircraft and other man-made emissions, in 2015 and 2050 relative to the year 1990, according to several global models, including IMAGES (Intermediate Model for the Annual and Global Evolution of Species) from BIRA / IASB. The impact of aircraft NO<sub>x</sub> (NO<sub>2</sub>+NO) emissions is shown to be significant. (IPCC 1999; J.-F. Muller, BIRA / IASB).

### 1.2.3 What have been the observed trends in episodic peak concentrations of tropospheric ozone and VOC emissions over Europe and Belgium in the 1990s?

In North-West Europe, although the background concentrations of ozone in the troposphere are increasing by 0.5 to 1%/yr, there is a clear trend showing that episodic peak ozone concentrations are decreasing. The annual maximum of all 8-hourly ozone peak concentration declines between -1.9 to -2.9 ppbv/yr (parts per billion by volume per year). These important trends are confirmed by the results of model studies looking at policy scenarios up to 2010. Indicators representing peak values (e.g., the

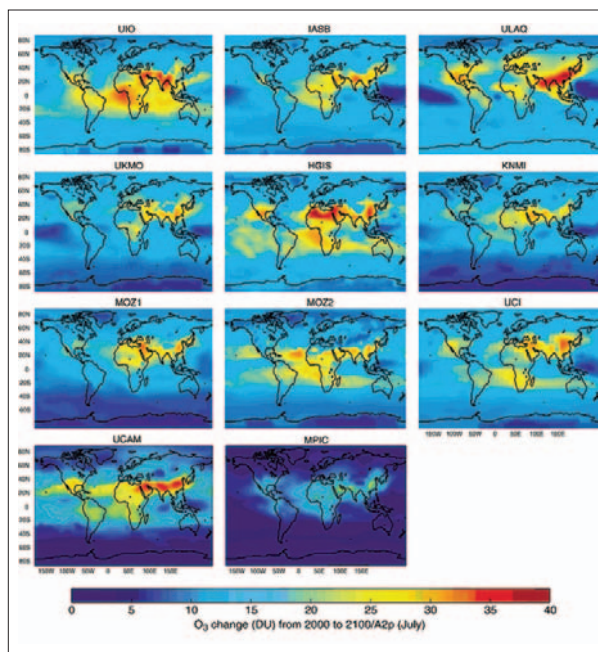

Figure 1.13 - Predicted change in the tropospheric ozone total column amount (in Dobson units) in July due to man-made emissions in 2100 relative to year 2000, according to 11 models of the global tropospheric composition, including IMAGES (Intermediate Model for the Annual and Global Evolution of Species) from BIRA / IASB. The IPCC projections for CH<sub>4</sub>, CO, VOCs, and NO<sub>x</sub> were used in these simulations (see IPCC Special Report on Emission Scenarios, IPCC SRES). The emission scenario accounts for the projected evolution in population number, GNP (Gross National Product) per capita, technology and pollution control measures in different parts of the world. The global tropospheric ozone is predicted to increase by up to 60% according to the different IPCC scenarios, but with a considerable uncertainty. Note that the possible impacts of climate change on the composition are not taken into account in these simulations, although they were shown to be potentially significant. (J.-F. Muller, BIRA / IASB).

number of days with a maximum 8-hourly ozone concentration higher than 60 ppbv) decrease significantly for the various policy scenarios. On the contrary, the average values (e.g., the average of all daily maximum 8-hourly ozone concentrations) are hardly changing or show a slight increase.

The UNECE's 1991 Protocol concerning the Control of Emissions of Volatile Organic

Compounds or their Transboundary Fluxes ('VOC Protocol' or 'Geneva Protocol') established under the CLRTAP has played an important role in reducing VOC emissions over the last decade. The member states agreed to a reduction of 30% by 1999, relative to the year 1988. Belgium ratified the VOC Protocol in November 2000, but did not fully achieve the required goals (see Figure 1.14).

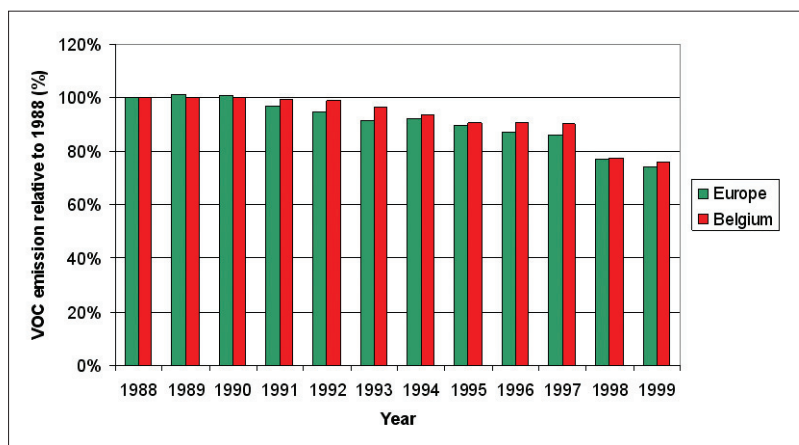

Figure 1.14 - Trends in emissions of Volatile Organic Compounds in Europe and Belgium, from 1988 to 1999. A decrease in VOC emissions is obvious. (J.-F. Muller, BIRA / IASB).

The total effort in Europe to reduce VOC emissions has led to a decrease in the concentrations of important VOCs, as demonstrated by measured urban background concentrations in London between 1994 and 2000, showing a decrease between 4.5% and 12%/yr, depending on the observed VOC component. Model studies show that the reductions in VOC emissions are consistent with the observed reductions in peak ozone concentrations discussed above.

#### 1.2.4 Is it necessary to reduce emissions of O<sub>3</sub> precursors other than VOCs in the future?

Despite the evidence that lower VOC emissions lead to reductions in peak ozone concentrations, reduction of precursors other than VOCs are

needed. The EC Directive on National Emission Ceilings (NEC) requires drastic reductions in NO<sub>x</sub> emissions as well. These will not only have a positive impact on ozone concentrations but will also help to abate acidification and eutrophication in Europe. This integrated approach, aiming to develop a long-term policy strategy against the combined effects of air pollution on human health and the environment, is relatively new and is reflected in the latest protocols. It is also the subject of the recently initiated European CAFE programme.

In this perspective, it is essential to provide policymakers with adequate tools for evaluating the impact of possible emission reduction strategies on ozone concentrations. Numerical atmospheric models are well suited for this task. These models describe the various atmospheric processes responsible for ozone formation and destruction: pollutant emissions, atmospheric dispersion and transport, chemical transformations and deposition. The global model IMAGES (Intermediate Model for the Annual and Global Evolution of Species) developed and used at BIRA / IASB is one among several models that is used to quantify the response of the global tropospheric composition to changing anthropogenic emissions. On the European scale, the EUROS model (European Operational Smog Model, developed by RIVM in The Netherlands), and more specifically the BELEUROS version adapted to Belgium by VITO-TAP and CELINE / IRCEL, are important tools supporting policy legislations on tropospheric ozone.

Based on the results of extensive calculations by the EUROS model, diagrams have been compiled that provide good insight into the non-linear character of the response of ozone to its precursors. Figure 1.15 shows the results of more than 100 scenario calculations combined in a diagram for the accumulated ozone concentrations in excess of 40 ppbv

## Atmospheric Composition Changes

(the so-called  $AOT_{40}$ ) in 1994 and 2010. Figure 1.16 shows the impact on episodic peak ozone concentrations over Europe of a 50% reduction in both  $NO_x$  and VOC emissions.

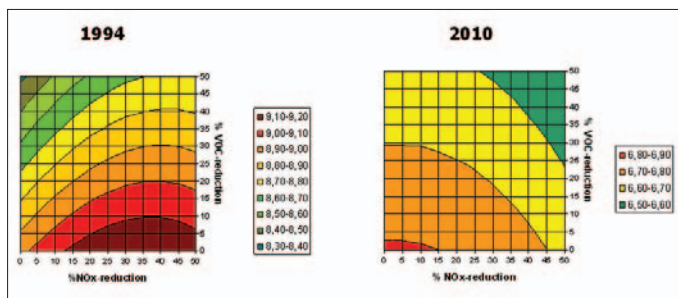

Figure 1.15 - Accumulated ozone concentrations in excess of 40 ppbv ( $AOT_{40}$ ), as a function of  $NO_x$  and VOC reductions in 1994 (left) and 2010 (right). The diagrams show that in 1994 a moderate reduction of  $NO_x$  emissions in Belgium would have resulted in an increase in  $AOT_{40}$ , whereas any reduction in VOC emissions would have resulted in a decrease in  $AOT_{40}$ . In 2010, both  $NO_x$  and VOC reductions would result in a decrease in the  $AOT_{40}$ . (C. Mensink, VITO-TAP).

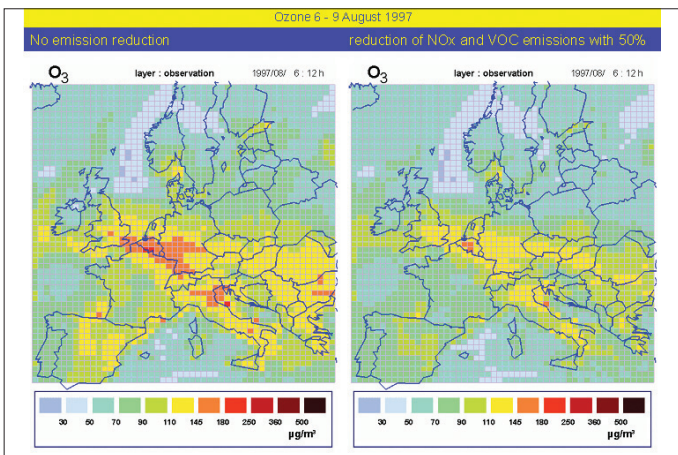

Figure 1.16 - Visualisation of episodic peak ozone concentrations over Europe on August 6, 1997 at 12.00h, as computed by the EUROS model, using emissions of 1997 without emission reductions (left) and with 50% reduction of  $NO_x$  and VOC emissions in Europe compared to 1997 (right). The  $O_3$  peak concentration is indicated according to the bottom colour scale ( $1 \mu g/m^3 O_3 = 0.70 \text{ ppbv } O_3$ ). According to these model simulations, reductions of  $NO_x$  and VOCs clearly have a positive impact on the tropospheric  $O_3$  peak concentrations. The effect is confirmed by present observations. (C. Mensink, VITO-TAP and CELINE / IRCEL).

### 1.2.5 Can we quantify the role of natural and anthropogenic VOCs in the troposphere?

The emissions of natural non-methane volatile organic compounds (NVOCs) are about an order of magnitude higher than anthropogenic emissions of these compounds on a global scale. Their chemical degradation has a strong impact on tropospheric ozone and the oxidising capacity of the atmosphere, because of their multiple influences on ozone and radicals (see Figure 1.9). In addition, their degradation leads to the formation of condensable compounds, which are a major source of secondary organic aerosols (SOAs). Model calculations suggest that SOA formation originating from NVOCs has increased 3-4-fold since pre-industrial times, which stresses their possible impact on radiative forcing. Quantification of this effect remains highly uncertain, however. A first reason for this is the oversimplified nature of NVOC emission models. The emissions are calculated as simple functions of temperature, light, and ecosystem type. The validation and improvement of emission models is a necessary task, carried out at BIRA / IASB for many years.

A second reason is the highly complex chemistry of these NVOCs. Thousands of organic constituents and reactions must be considered in order to understand their role in the atmosphere. A vast majority of these constituents has never been directly studied in the laboratory. The complex molecular structure and properties of many NVOCs make them particularly difficult to investigate by either experimental or theoretical means. This is particularly true for the monoterpenes, which constitute an important class of NVOCs emitted by vegetation (mostly trees). While a wide variety of oxidation products has been observed, their yields show a large uncertainty range. These yields are strongly dependent on photochemical conditions and are highly variable in the real atmosphere. An innovative

combination of laboratory, theoretical, and modelling studies is necessary to reduce the uncertainties on these processes.

For over a decade at KULeuven-PAC and for a couple of years at BIRA / IASB, the reactions of important monoterpenes ( $\alpha$ -pinene,  $\beta$ -pinene and limonene) with hydroxyl radicals (OH) have been studied in the laboratory (see Figure 1.17). Product yields have been quantified over a wide range of reaction conditions by modern mass spectrometric techniques.

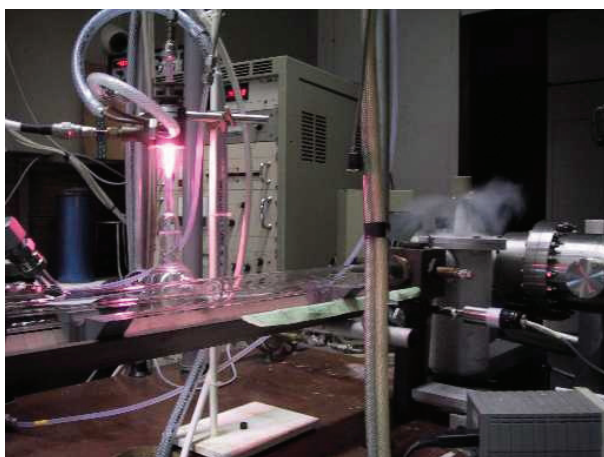

Figure 1.17 - Fast-flow reactor in operation at KULeuven-PAC. This instrument, in combination with on-line mass spectrometric detection, has been built for determining the products of monoterpene reactions. This approach represents a smaller-scale alternative to the more expensive and less accessible research facilities in Europe. Hydroxyl radicals (OH) are produced in the afterglow of microwave-induced plasma. A methodology has been developed for the analysis of degradation products. (C. Vinckier, KULeuven-PAC).

An instrument developed at BIRA / IASB combines the powerful technique of chemical ionisation with the neutral fast flow technique also used at KULeuven-PAC. This combination offers the novelty and advantage of a fast response and on-line quantification. The technique is absolute and requires only a minimum of calibrations if the rate constants (or rate coefficients) and the product ion distributions of the ion-molecule reactions involved in the

detection technique are available. Since these parameters are unknown for some ion-molecule reactions, another instrument (Selected Ion Flow Tube, SIFT) has been developed. The data obtained with this instrument are not only valuable for research on monoterpenes, but are also of relevance to scientists using chemical ionisation as a detection technique.

In order to model the impact of VOC oxidation on tropospheric ozone and on the free radical budget under real atmospheric conditions, the various (subsequent or competing) 'elementary' reaction steps in the VOC oxidation mechanism must be characterised. To this end, an innovative approach has been developed at KULeuven-PAC, in which the reactions of the various highly reactive radical intermediates involved in oxidation of a given VOC are fully characterised, theoretically. This pioneering approach uses the most advanced methodologies existing today. It was first applied to the oxidation of small VOCs (in particular ethene and propene), for which the theoretically predicted product yields could be successfully validated against the extensive sets of experimental results available. The same theoretical methods were then applied to more complex VOCs: the monoterpenes  $\alpha$ -pinene and  $\beta$ -pinene and pinonaldehyde (a major degradation product of the former). Here also, the predicted yields of major products generally agree with the experimental data, lending strong support to the soundness and reliability of this novel approach of 'objective' development of oxidation mechanisms. In close collaboration with KULeuven-PAC, BIRA / IASB has implemented this new detailed monoterpene mechanism in a numerical model which calculates the fate of degradation products under real (laboratory or atmospheric) conditions. This is a first step towards its implementation in a global model, in order to predict the quantitative impact of these NVOCs on the budgets of both ozone and free

# Atmospheric Composition Changes

radicals, and on the formation of aerosols in the troposphere.

Among other useful tools in mechanism construction, KULEuven-PAC has developed sets of rules for characterising a specific type of reaction of a given VOC or intermediate radical, solely on the basis of its chemical structure. Such validated rule-sets have been worked out for various key reaction types in the oxidation of VOCs. These new tools and the novel theoretical approach described above should prove of much value in constructing the oxidation mechanisms of dozens of complex VOCs. Moreover, the rule-sets can, in principle, directly be implemented in modelling studies of ozone production from many VOCs, simultaneously.

## 1.3 Tropospheric aerosols: what are their physico-chemical characteristics, their sources, and their impacts on climate forcing and human health, and is there a change?

### 1.3.1 Introduction

Aerosols are tiny liquid or solid particles suspended in the atmosphere. They have diameters ( $\varnothing$ ) ranging from 1 nanometre (nm) to over 10 micrometres ( $\mu\text{m}$ ), but most of their mass is in the size range from about 0.1 to 10  $\mu\text{m}$ . They originate from a wide variety of natural and anthropogenic processes and exhibit considerable spatial and temporal variability. The production mechanisms are: (i) direct injection of particles into the atmosphere, mostly by dispersion processes, resulting in so-called primary (and coarse,  $\varnothing > 1 \mu\text{m}$ ) aerosols, and (ii) transformation of inorganic and organic gaseous precursors into secondary (and fine,  $\varnothing < 1 \mu\text{m}$ ) aerosols. Examples of primary aerosol types (or components) are soil dust, sea salt, road dust, coal fly ash, primary industrial

dusts, primary biogenic particles, and elemental (or black or soot) carbon, while secondary particles consist of sulphates, nitrates, ammonium, and secondary organic aerosols (SOA). It is believed that sources of human origin have increased substantially during the 20<sup>th</sup> century. For example, large amounts of sulphur dioxide ( $\text{SO}_2$ ) are released into the atmosphere by coal and oil combustion, while deforestation, savannah fires, and other biomass burning in the tropics inject large amounts of carbonaceous matter as elemental and organic carbon. Because of the great variability in sources, the size distribution, chemical composition, and physical properties of the aerosol particles can also vary widely. Major components of fine aerosols in urban areas are carbonaceous matter, sulphate, and nitrate of man-made origin, whereas aerosols over the remote oceans consist mostly of sea salt and biogenic sulphate. Aerosols play an important role in atmospheric chemistry, have adverse effects on human and animal health and welfare, and influence climate. The climatic effect of aerosols stems from the fact that they physically affect the heat balance of the earth: changes in the heat balance due to anthropogenic or externally imposed changes are referred to as forcings (see Chapter 2). The size distribution of aerosols is crucial to all climate influences.

### 1.3.2 What are the major aerosol components and can we achieve mass closure?

Chemical analysis of atmospheric aerosols (as a function of size) is needed to assess their effects on human health and climate and to get information that can be used for identifying aerosol sources and developing mitigation strategies. It is important to measure the major aerosol components (aerosol types) and to examine to what extent particulate matter (PM) can be explained by the measured components and thus, to what extent aerosol

chemical mass closure can be achieved (this happens when the concentrations of individually measured components add up to the directly measured total mass concentration). The aerosol components normally measured in mass closure studies are organic matter (OM), elemental carbon, sulphate, nitrate, ammonium, crustal matter, and sea salt. UGent-INW has performed a number of such studies. During the fall of 1999, a mass closure study was performed in Gent, whereby the aerosol was separated into 9 size fractions. The results are shown in Figure 1.18. The average PM10 (particulate matter of  $\text{Ø} < 10 \mu\text{m}$ ) mass concentration in this study was  $27 \mu\text{g}/\text{m}^3$ , and 70% of it was in the  $\text{Ø} < 1.8 \mu\text{m}$  size fraction. Emissions from traffic are expected to provide the largest contribution to the fine and ultra-fine OM. On the average, 74% of the PM was accounted for by the measured aerosol types. The unexplained mass is likely attributable to ammonium nitrate and water, which were not measured. Another example is a study performed as part of the EUROTRAC-2 subproject 'AEROSOL - field experiment INTERCOMP 2000' which took place in April 2000 in Melpitz near Leipzig (Germany). PM10 aerosols were collected in two size fractions (coarse,  $\text{Ø} = 2\text{-}10 \mu\text{m}$ , and fine,  $\text{Ø} < 2 \mu\text{m}$ ). Coarse PM amounted on the average to  $5 \mu\text{g}/\text{m}^3$ , while fine PM was  $12 \mu\text{g}/\text{m}^3$ . It was found that crustal matter, OM, and nitrate were the major aerosol types in the coarse size fraction. The dominant aerosol types in the fine fraction were OM, nitrate, and sulphate. The latter results are similar to the grand-average percentages in the PM2.5 (PM of  $\text{Ø} < 2.5 \mu\text{m}$ ) aerosols of near-city and urban background sites in Europe. For both size fractions at Melpitz, essentially complete

chemical mass closure could be achieved. It can be concluded that measurement of the major aerosol components and chemical mass closure are currently possible.

It is also of interest to separate the OM into different compound classes and to determine which fraction of the OM is water-soluble. While determining the water-soluble fraction can be achieved reasonably well, speciation of the OM is a much more complex task. By means of detailed analyses of aerosol samples from Gent, over 100 individual organic compounds were identified and measured. However, they accounted for only about 10% of the OM. Similar results have been found by other research groups in Europe and the USA.

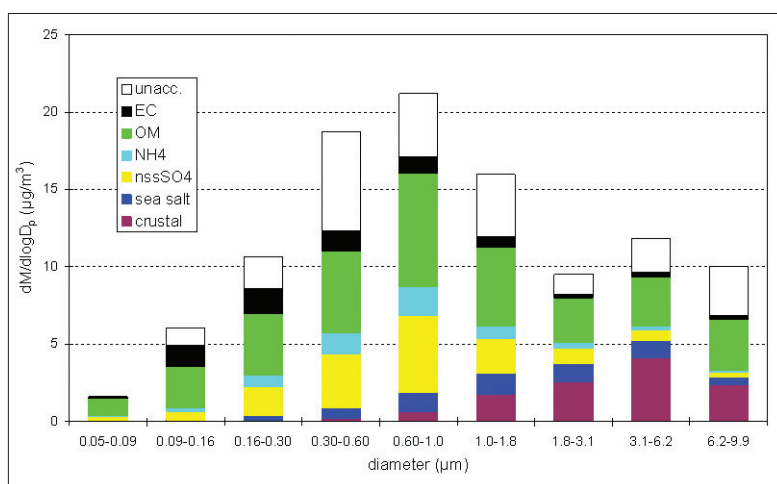

Figure 1.18 - Size-segregated aerosol chemical composition during the fall of 1999 in Gent, Belgium. Mass concentrations per logarithmic particle size interval are given as a function of particle diameter intervals, for various aerosol types: EC= elemental carbon; OM = organic matter;  $\text{NH}_4$  = ammonium;  $\text{nssSO}_4$  = non-sea salt sulphate; crustal = crustal matter. (W. Maenhaut, UGent-INW).

### 1.3.3 Can we quantify the natural and anthropogenic contributions to aerosol formation?

Measurement of the major aerosol components and chemical mass closure studies already provide some information of use in source



# Atmospheric Composition Changes

identification. However, in order to identify the various source categories, to apportion the PM and its major constituents, and to differentiate between the natural and anthropogenic contributions, other approaches are needed. UGent-INW has performed several such studies for a variety of sites. Research at the Zeppelin station in Spitsbergen (Norway) indicated that about one-third of the fine sulphate present during summer originates from natural biogenic sources (i.e., from emission of dimethyl sulphide by marine phytoplankton) and that the remaining two-thirds is anthropogenic. In contrast, during winter and early spring, all of the fine sulphate at the site is from anthropogenic sources in Asia and Europe. From studies at equatorial and tropical locations, it was found that most of the fine PM during biomass burning in the dry season is attributable to pyrogenic emissions. During SAFARI-92 (Southern African Regional Science Initiative), which is part of one of the IGBP (International Geosphere-Biosphere Programme) core projects called IGAC (International Global Atmospheric Chemistry), around 40% of the fine PM over the eastern Transvaal (South Africa) was apportioned to biomass burning and about 33% to sulphate, which mainly originated from the power plants and industrial activities on the Transvaal Highveld. For two sites in the Amazon basin, Brazil, over 70% of the dry season fine PM was attributed to pyrogenic emissions. Since 1997, the bulk aerosol investigations have been extended to analyses of organic and elemental carbon, and in co-operation with UA-Phar, also to detailed analyses of organic compounds. In recent years, levoglucosan (an excellent indicator of wood and biomass burning) and various other organic tracers have been added to the list of measured compounds. At the Gent site, high levels of levoglucosan are found during winter, while concentrations during summer are about 20 times lower. Preliminary source

apportionments suggest that about one-third of the PM<sub>10</sub> organic carbon during winter at the Gent site originates from wood burning. Levoglucosan was also measured in aerosol samples collected during SAFARI 2000 in South Africa and more recently in Brazil. The sampling set-up used during SAFARI 2000 is shown in Figure 1.19.



Figure 1.19 - Aerosol sampling set-up used during SAFARI 2000 in the Kruger National Park, South Africa. (W. Maenhaut, UGent-INW).

Individual particle analyses by electron (and other) microscope techniques are a useful complement to bulk chemical analyses for source identification and apportionment. They often enable one to obtain a finer resolution of contributing particle types than is possible by bulk analyses. Furthermore, certain microscope techniques, such as transmission electron microscopy, can provide information on the shape and state of mixing of the particles. Such information is of importance in estimating the direct radiative effects of aerosols. UA-MiTAC has applied various microscope techniques for examining aerosol samples collected in southern Africa during SAFARI-92, in Israel, Brazil, Antarctica, over the North Sea and the Russian Arctic sea, and at many other sites worldwide, often within the context of international campaigns such as the Monterey

Area Ship Track (MAST) experiment and the Aerosol Characterisation Experiments ACE-2 and -3 (also part of the IGBP core project IGAC).

In order to examine changes over time in the concentrations of important aerosol components, UGent-INW is performing long-term aerosol collections at a number of sites (Spitsbergen, since 1991; Israel, since 1995; Zimbabwe, 1994-2000) and studying the samples by means of bulk analysis techniques.

### **1.3.4 Can we quantify the aerosol contribution to direct and indirect climate forcing?**

Aerosols affect the earth heat balance both directly, by reflecting and absorbing solar radiation and by absorbing and emitting some terrestrial infrared radiation, and indirectly, by influencing the properties of and processes in clouds. Due to the spatial and temporal variability of anthropogenic aerosols, forcing has a strong regional character, so that the climate response to aerosol forcing is also regionally heterogeneous. To estimate and predict direct and indirect climate forcing, we need knowledge about the chemical composition and physical properties, and in particular the size distribution, of aerosols (IPCC TAR, 2001). For example, sub-micrometre aerosols scatter more light per unit mass and have a longer atmospheric lifetime than aerosols with a larger particle size.

Calculation of the global annual-mean radiative forcing by atmospheric constituents requires knowledge of their concentrations over wide spatial regions and over long time periods. For short-lived compounds like aerosols having a lifetime of the order of days, the required global observations are not yet in place. Thus, estimates are drawn from model simulations of their three-dimensional distributions, whereby one makes additional simplifying assumptions, for example about the mixing of tropospheric aerosol components. The

indirect forcing due to tropospheric aerosols is poorly understood. Several contributions to it are currently considered. The 'first' indirect effect is the forcing due to modification of the radiative properties of clouds (cloud albedo effect); it results from the fact that aerosol particles are needed to form cloud droplets and that, for a given mass of water in the air, more particles give rise to more (and smaller) cloud droplets with a larger reflecting surface area. The 'second' indirect effect deals with the role of anthropogenic aerosols upon the lifetime of clouds (cloud lifetime effect): it is a consequence of the fact that the number of aerosol particles affects the size of the cloud droplets. The radiative flux perturbation associated with the cloud lifetime effect is very difficult to quantify: available models predict that it is of a magnitude similar to that of the cloud albedo effect, which has been estimated to be of the order  $-0.3$  to  $-1.8$   $\text{W}/\text{m}^2$ .

Under most circumstances, the combined climatic effect of aerosols is in the direction of cooling, with a magnitude comparable to that of greenhouse gas warming. Figure 1.20 shows the latest IPCC estimates and associated uncertainties for the global, annual-mean radiative forcings due to a number of agents from the pre-industrial period (1750) to the present. For the well-mixed greenhouse gases, the radiative forcing amounts to  $+2.43$   $\text{W}/\text{m}^2$ , with an uncertainty of only  $\pm 10\%$ . The direct radiative forcings for each of the five anthropogenic aerosol types are typically a factor 10 smaller (in absolute value) but have uncertainties of the order of  $\pm 100\%$ . As explained above, the indirect forcing due to tropospheric aerosols is subject to very large uncertainties.

UGent-INW was involved in the investigation of the physical, chemical, and optical-radiative characteristics of aerosol parameters of relevance to direct radiative forcing. Among the relevant radiative aerosol properties are

# Atmospheric Composition Changes

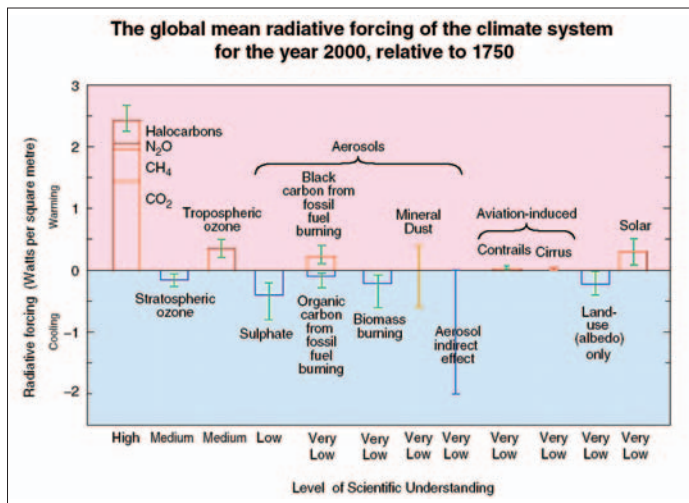

Figure 1.20 - Current estimates of the radiative forcing due to increased concentrations of atmospheric constituents and other mechanisms. Note that certain aerosol types (sulphate, biomass-burning aerosols) lead to cooling, whereas others (black carbon) lead to warming. Also, note the very large uncertainty as to the indirect aerosol forcing. (IPCC TAR, 2001).

the aerosol refractive index, light scattering and light absorption, and column-integrated optical depth. At a site in the Negev desert in Israel, an analysis showed that anthropogenic aerosols accounted for about 70% of the observed total light scattering, the rest being dominated by the effect of dust events. The radiative forcing by anthropogenic aerosols in this region was estimated using two different approaches. The most detailed one yielded an all-sky radiative forcing of  $-2.5$  and  $-4.9$   $W/m^2$  over desert and ocean surfaces respectively. These data are very similar to predictions from global models of aerosol radiative forcing.

UGent-INW and UA-Phar are also currently contributing to research in the Amazon Basin, Brazil, dealing with the indirect climatic effect of biomass burning aerosols.

### 1.3.5 What are the effects of tropospheric aerosols on human health?

Public concern about air pollution has been stimulated by dramatic episodes resulting in

serious health effects, like those recorded in the Meuse valley, Belgium, in 1930, and in London, in December 1952. In the latter case, some 4,000 persons died prematurely, clearly because of the high levels of  $SO_2$  ( $\sim 2,000$   $\mu g/m^3$ ) and synergic effect of smoke. Since then, the  $SO_2$  problem has been remedied to a large extent. At present, however, particulate matter remains the most important ambient air pollutant resulting in adverse health effects, both at short-term, high-level exposures and at prolonged, chronic exposures to lower concentrations. The respiratory tract serves both as a target organ and as an entry portal for pollutants that may cause diseases in other organs. The gas exchange area of the lungs is approximately  $30$   $m^2$  and is spread out over  $2,000$   $km$  of capillaries. This network facilitates the exchange of both vital gases and pollutant gases, and acts as a deposition surface for soluble and insoluble fine particles.

The health consequences of atmospheric particulate matter depend on its ability to penetrate the respiratory system. Size, shape, and density are important parameters in this context. The human respiratory system is able to remove particles larger than  $10$   $\mu m$  from the inhaled air stream, in the nasal region. Figure 1.21 illustrates the penetration of particles into the respiratory tract. Particles with a diameter ranging from  $5$   $\mu m$  to  $10$   $\mu m$  get only as far as the upper airway system, while particles smaller than  $5$   $\mu m$  enter the lower respiratory system. The alveoli are reached by the fraction with a diameter smaller than  $1$   $\mu m$ .

Adverse effects of particulate matter may be caused by the direct irritant effects of particles such as sulphuric acid, or by secondary toxic effects. Certain substances such as sulphur oxides, polyaromatic hydrocarbons (PAHs), and heavy metals (lead, cadmium, zinc, mercury) are absorbed readily onto the relatively larger surface area of lung-penetrating

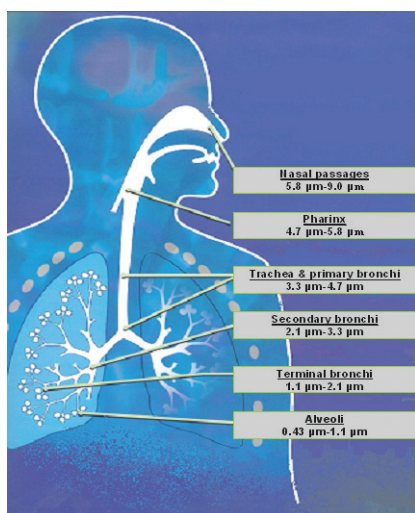

Figure 1.21 - Inhalation of particles in the human respiratory system. For each 'branch' of the system, the upper size limits for particle penetration are indicated. (Westech Instrument Publicity folder; R. Van Grieken, UA-MiTAC).

fine particles. The concentration of absorbed substances and the resulting delivered dose may be considerably higher than inferred from concentrations in the ambient atmosphere.

Air pollution effects on the respiratory system are broadly classified as acute (short term) or chronic (long term). Acute effects are often referred to as 'asthma'. Asthma has a broad range of triggers, resulting in symptoms of shortness of breath and breathing difficulty. Chronic lung diseases result from gradual damage and reduced functioning of the lower airways. This includes accumulation of insoluble fine particles, development of fibrosis, and loss of alveolar elasticity. A reduced gas-transfer capacity leads to a greater load on the heart and lungs in order to obtain the required quantities of oxygen, leading to greater stress on the cardio-vascular system. This cardio-vascular stress is more often the proximate cause of death than lung failure.

Several large-scale epidemiological studies have now established significant correlations between airborne fine particulate matter and increases in all-cause mortality, including

both respiratory and cardiac diseases, cardio-respiratory hospitalisations, and respiratory system illnesses.

Since people spend around 80% of their time indoors, the potential health effects of indoor air pollution are being investigated as well, environmental tobacco smoke being the most important contributor to adverse air quality there. Some studies in this field carried out at UA-MiTAC (on behalf of the Flemish government) have shown that the prevalence of asthma in young adults is 2.5 times higher in the centre of Antwerp than in the surrounding, more rural areas. Extensive indoor and outdoor measurements of PM<sub>2.5</sub> and organic and inorganic gases are now being carried out, both in schools and in residences, in the centre and the surrounding areas of that city. In the future, both outdoor and indoor background measurements of ozone and aerosols should be considered, and performed simultaneously.

### 1.3.6 Does and will Belgium meet European standards for particulate matter?

Legislation for particulate matter in the EU is expressed in terms of target values for PM<sub>10</sub>. The EU standards to be met by January 2005 are the following: the 24-hour limit value of 50 µg/m<sup>3</sup> PM<sub>10</sub> is not to be exceeded more than 35 times/yr, and the annual standard is 40 µg/m<sup>3</sup> PM<sub>10</sub>. By January 2010, both the 24-hour limit value and the annual standard will become more stringent: the annual standard will then be 20 µg/m<sup>3</sup> PM<sub>10</sub>. In the USA, standards exist for both PM<sub>10</sub> and PM<sub>2.5</sub>; for PM<sub>2.5</sub>, the annual standard is 15 µg/m<sup>3</sup> (3-year average). In order to examine whether these various standards are currently met in Europe and to assess what are the major components of the PM<sub>10</sub> and PM<sub>2.5</sub> aerosol mass, the EC Joint Research Centre in Ispra (JRC-Ispra, Italy) coordinated a study of European aerosol phenomenology. Physical and chemical characteristics of particulate matter

# Atmospheric Composition Changes

collected over the past 10 years at kerbside (i.e., along roads), urban, rural, and background sites in Europe were examined. UGent-INW participated in this study, providing data sets for urban background and near-city sites in Belgium (Gent and Waasmunster) and for three natural background sites in Scandinavia (i.e., Sevettijärvi in Finland, and Birkenes and Skreådalen in Norway).

Figures 1.22 and 1.23 show the 5th, 25th, 50th (median), 75th, and 95th percentiles of 24-hour-averaged PM10 and PM2.5 mass concentrations measured at the various sites (note that a few sites did not perform both measurements), as well as their annual averages. The results in Figure 1.22 indicate that only a few sites exceed the EU annual PM10 limit value targeted by 2005, whereas all kerbside, near-city background, and urban background sites are above the EU annual PM10 limit value of 20  $\mu\text{g}/\text{m}^3$ , targeted for 2010. In addition, the 95th and 75th PM10 percentiles indicate that the EU 24-hour PM10 limit value is exceeded more than 18 and 90 times a year, respectively, at most near-city, urban background, and kerbside sites. Targets are 35 exceedences a year by 2005 and 7 exceedences a year by 2010. As of today, the EU has not put forward any PM2.5 limit values. However, the annual average PM2.5 mass concentration at all near-city and urban background sites and at kerbside sites exceeds the US standard of 15  $\mu\text{g}/\text{m}^3$  (see Figure 1.23). The JRC-Ispra study demonstrated that resuspended road dust was a major component of the PM10 aerosol (and the dominant component of the coarse aerosol) at kerbside sites and that road traffic is responsible for the high PM10 and PM2.5 concentrations.

In Belgium, PM10 (and to some extent also PM2.5) have been monitored on a continuous basis at several locations by governmental organisations (e.g., CELINE / IRCEL and VMM) for many years. A comparison between

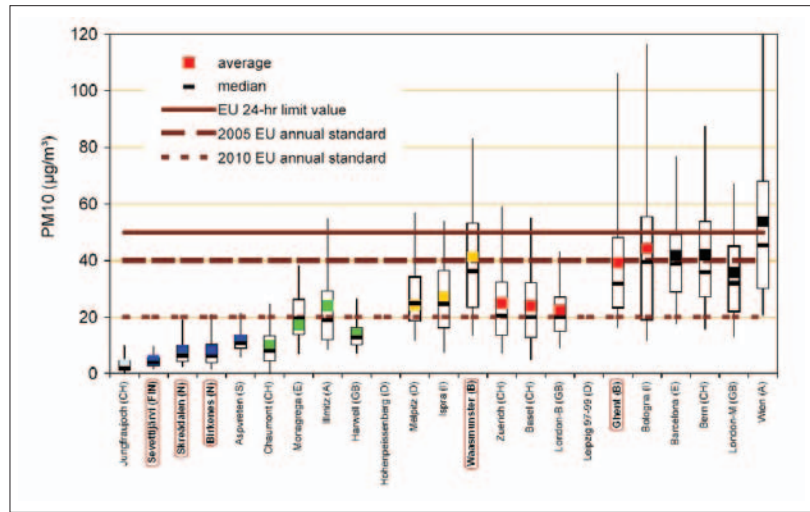

Figure 1.22 - Comparison of aerosol mass concentration measurements at various sites in Europe, for aerosol particles less than 10  $\mu\text{m}$  in diameter (PM10). The sites for which UGent-INW provided the data are highlighted. The colour code indicates different aerosol types: blue = natural background; green = rural background; yellow = near-city background; red = urban background; black = kerbside (i.e., along roads in cities). The data shown are the 5th, 25th, 50th (median), 75th, and 95th percentiles of 24-hour integrated PM10 mass concentrations, as well as their annual averages. The horizontal lines indicate target upper limit values to be achieved in the near future. (report EUR 20411 EN, 2000; W. Maenhaut, UGent-INW).

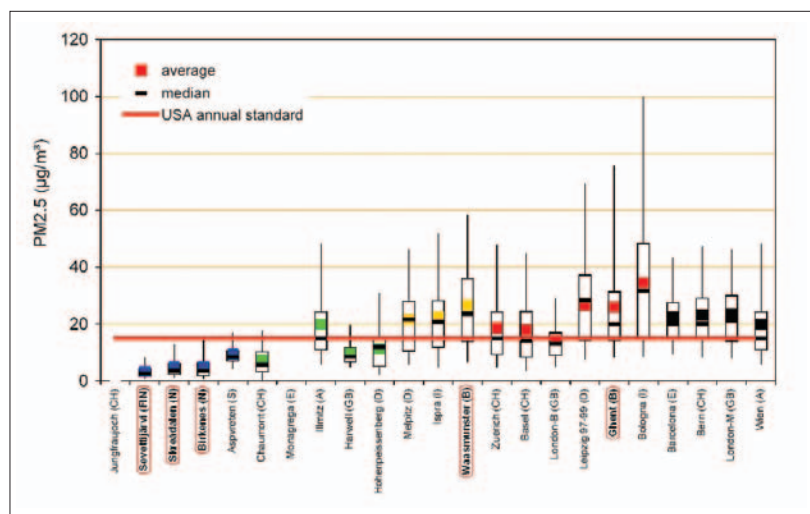

Figure 1.23 - Comparison similar to that in Figure 1.22, but for aerosol particles less than 2.5  $\mu\text{m}$  in diameter (PM2.5). (report EUR 20411 EN, 2000; W. Maenhaut, UGent-INW).

the 1995 and the 2000 status of PM sources is shown in Figure 1.24.

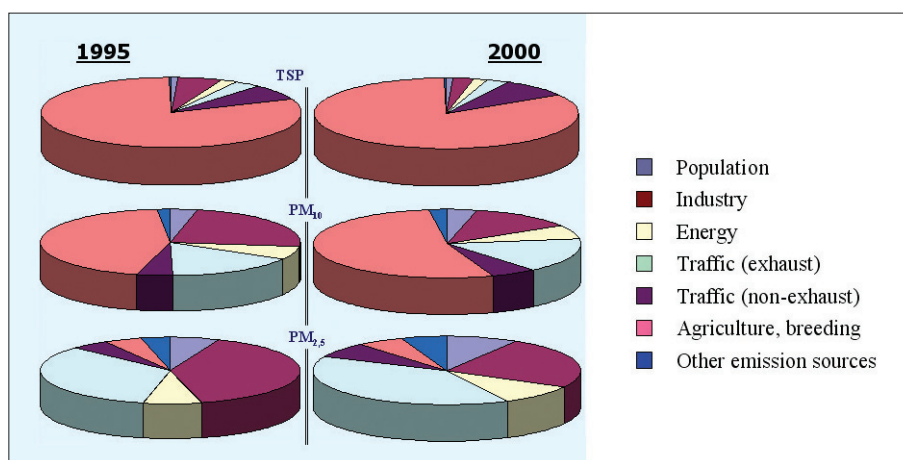

Figure 1.24- Different source contributions to the observed PM<sub>10</sub> (PM less than 10 μm in diameter), PM<sub>2.5</sub> (diameter <2.5 μm) and TSP (total suspended particulate matter) in Flanders, and their evolution between 1995 and 2000. (VMM report 'Emissions in the air 1990-2002'; R. Van Grieken, UA-MiTAC).

## 1.4 How have further Belgian activities contributed to atmospheric research strategies from the regional to the global scale?

### 1.4.1 Introduction

The different subsystems in the earth atmosphere are strongly coupled. Therefore, one cannot deal distinctly with individual components like the planetary boundary layer, the free troposphere, and the stratosphere. Nor can one separate the evolution of the chemical composition from changing dynamics, radiative forcing, and climate. Only combined measurements using both in situ and remote sensing techniques from various platforms can be considered appropriate for achieving an overall coherent picture of atmospheric changes and related processes. Different measurement strategies are thus applied, using surface-based, airborne, and space-borne observational techniques ranging from individual measurements to coordinated

campaigns investigating multiple constituents, from the local to the global scale, covering both the short- and long-term time periods over which processes and changes are taking place.

As a permanent challenge, the discovery of new processes implies the development of new techniques to measure not only additional gaseous

trace components of the atmosphere, but also the chemical composition and physical properties of various types of particles ranging from cloud droplets and ice particles to natural and anthropogenic aerosols. New measurement techniques often require sophisticated data analysis and interpretation tools, and support from laboratory experiments and fundamental research will remain mandatory.

Since 1990, Belgium has contributed significantly to the 'Integrated Global Observing Strategy' (IGOS) through past and ongoing active participation in ground-based networks like the NDSC (which is an integral part of WMO-Global Atmosphere Watch, WMO-GAW), in international field research campaigns (EASOE, SESAME, THESEO, THESEO2000, and Vintersol - Validation of International Satellites and Study of Ozone Loss) organised by the European Ozone Research Coordinating Unit (EORCU) or in the framework of EUROTRAC, EUROTRAC-2, and several IGBP-IGAC activities like the Biomass Burning Experiment (BIBEX), the Large-scale Biosphere-Atmosphere Experiment in Amazonia (LBA), and SAFARI 2000. It has also contributed extensively to instrument development, to the production of fundamental spectroscopic

# Atmospheric Composition Changes

and kinetic parameters, to calibration and validation campaigns, to model and data processing or retrieval algorithm development and intercomparisons, etc. In addition to related activities already mentioned in previous sections, additional Belgian contributions of international relevance are further highlighted in Sections 1.4.2-1.4.5.

## 1.4.2 What has been gained from synergistic exploitation of different observing systems?

Geophysical validation of measurement data, the construction of a composite climatology, and the study of the partitioning of 'families' of gases are three major illustrations of what Belgian teams have achieved through synergistic use of complementary components of the global observing system.

To enable the correct use of complementary datasets, the specificities (e.g., vertical and spatial resolution) and geophysical usability (e.g., real information content and sensitivity to geophysical features) of each set must be well understood. This requires careful investigation and documentation of instrument performances and data processing characteristics. The datasets must also be quality controlled, in the short and long term. This is particularly true of satellite data. These provide unique access to the global picture, but satellites generally have a shorter lifetime than ground-based systems and the quality of their temporal data is more difficult to control owing to instrument degradation in space. This is why geophysical validation is an essential part of satellite experiments.

BIRA / IASB, ULg-GIRPAS, and IRM / KMI have provided significant contributions to the validation of major satellite data sets, including the O<sub>3</sub>, NO<sub>2</sub>, and BrO data from GOME (Global Ozone Monitoring Experiment) on ERS-2 (European Remote Sensing Satellite-2). They are extending these studies to the three

atmospheric chemistry instruments on the European Environmental Satellite ENVISAT (GOMOS = Global Ozone Monitoring by Occultation of Stars; MIPAS = Michelson Interferometer for Passive Atmospheric Sounding; SCIAMACHY = Scanning Imaging Absorption Spectrometer for Atmospheric Cartography), but further including CO, CH<sub>4</sub>, N<sub>2</sub>O, and HNO<sub>3</sub>, as well as stratospheric aerosols. BIRA / IASB contributed also to the validation of the 25-year-long O<sub>3</sub> time series acquired by 3 successive TOMS (Total Ozone Mapping Spectrometer) satellites. Recently, BIRA / IASB and ULg-GIRPAS provided an important contribution to the validation of the CO data products from the MOPITT (Monitoring of Pollution In The Troposphere) instrument launched onboard the Terra satellite in 1999 (see Figure 1.25). Besides GOME, MOPITT is one of the first satellite instruments aiming at global measurements in the troposphere, down to the ground. The intercomparison has taken into account the differences in information content of the data involved, taking further advantage of recent progress in retrieval techniques for the derivation of information about the vertical distribution of trace gases observed with ground-based remote sensing instruments such as FTIRs.

Another synergistic application of complementary data records is the development of composite climatologies. Figure 1.26 illustrates the construction of the BIRA / IASB climatology of NO<sub>2</sub> profiles. It relies on the complementarity of data provided by three space instruments (HALOE = Halogen Occultation Experiment; POAM-II and -III = Polar Ozone and Aerosol Measurement; second & third phases) over the upper and middle stratosphere, about 80 SAOZ-balloon flights (Système d'Analyse par Observations Zénithales) in the upper troposphere/lower stratosphere region, 3-D modelling results in

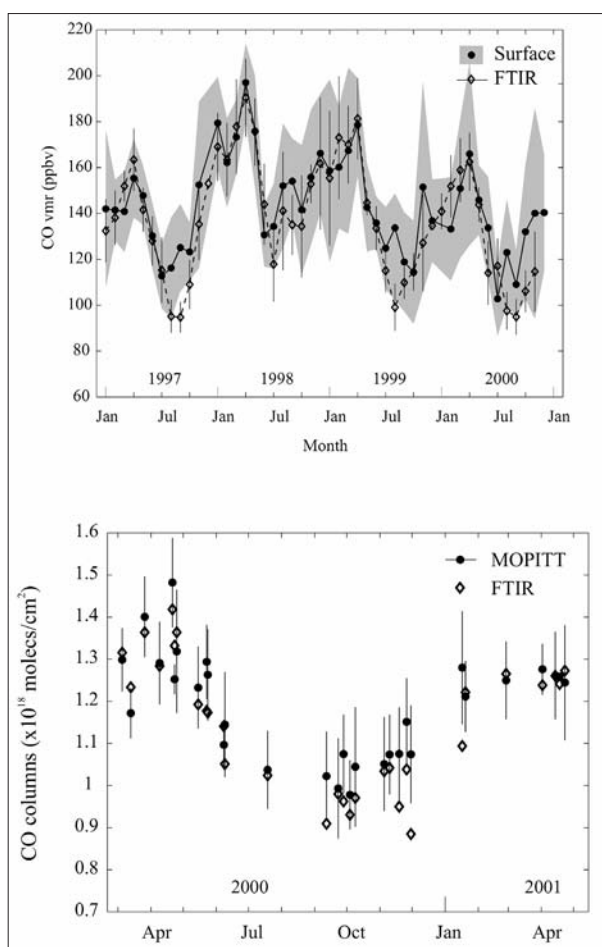

Figure 1.25 - Example of the synergistic use of multiplatform measurements of carbon monoxide (CO) abundances at the Jungfraujoch (Switzerland), for the assessment of their respective qualities. Top panel: comparison between monthly means of CO surface volume mixing ratios as measured in situ by the Swiss Federal Laboratories for Materials Testing and Research (EMPA) and remotely by Fourier Transform Infrared (FTIR) spectrometers operated by ULg-GIRPAS. Bottom panel: comparison between daily means of CO column amounts above the station's altitude measured by FTIR and by Monitoring of Pollution In The Troposphere (MOPITT). The very strong similarity between the ground-based remote sensing FTIR measurements and the in situ and space-borne infrared measurements helps scientists to gain confidence in the ability of a ground-based FTIR to monitor the vertical distribution of CO in the lower atmosphere. (B. Barret, BIRA / IASB and E. Mahieu, ULg-GIRPAS).

the troposphere, and information on variability provided by the ground-based NDSC network. This NO<sub>2</sub> climatology has been selected for the

next generation of the COSPAR (Committee on Space Research) International Reference Atmosphere (CIRA) database, an international standard that has been regularly updated over the past decade. Such climatologies are used worldwide in various applications, including atmospheric radiative transfer modelling, satellite validation, initialisation and verification of models and retrievals, etc.

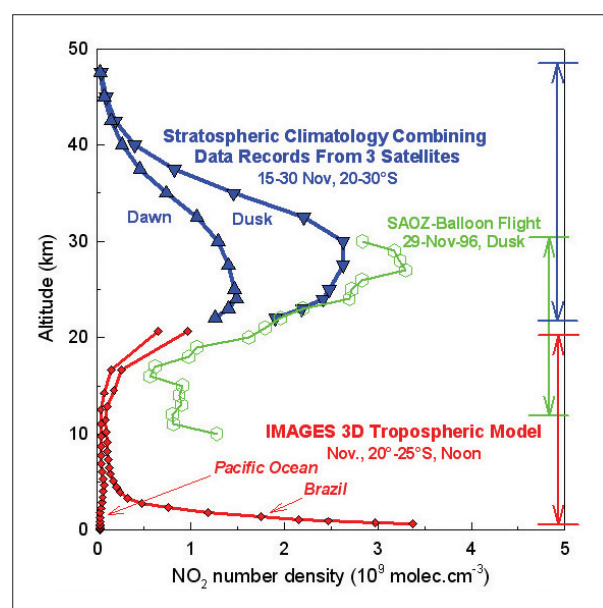

Figure 1.26 - Construction of a composite climatology of NO<sub>2</sub> profiles above Bauru (Brazil, 22°S) using complementary measurement records from satellites and balloons and from modelling results (dawn = sunrise; dusk = sunset). (J.-C. Lambert, BIRA / IASB).

The ATMOS project (Atmospheric Trace Molecule Spectroscopy, a core experiment of NASA's 'ATLAS Mission to Planet Earth'), to which ULg-GIRPAS contributed intensively, relied on the operation of a state-of-the-art FTIR spectrometer during four Space Shuttle flights between 1985 and 1994 to measure the quasi-global distributions of more than 30 atmospheric gases and establish trends for many of them over that ten-year period. The simultaneous investigation of multiple constituents has made it possible to study the partitioning of



# Atmospheric Composition Changes

'families' of gases such as the nitrogen oxides and to determine vertical distributions and total budgets of chlorine (see Figure 1.27) and fluorine compounds throughout the middle atmosphere (~7 to 60 km altitude). Where appropriate, these have been complemented and intercompared successfully with correlative balloon-, airplane-, ground-based, and in situ measurements. They constitute 'benchmarks' for future atmospheric change assessments.

SCISAT-1, with a nominal lifetime of at least 2 years. Belgian scientists from BIRA / IASB, ULB-SPECAT and ULg-GIRPAS are officially involved. The ACE experiment includes an FTIR instrument (like ATMOS) and a UV-Visible spectrometer (MAESTRO = Measurements of Aerosol Extinction in the Stratosphere and Troposphere Retrieved by Occultation). It will extend the ATMOS data series from the 1980s and 1990s into the present decade. New with

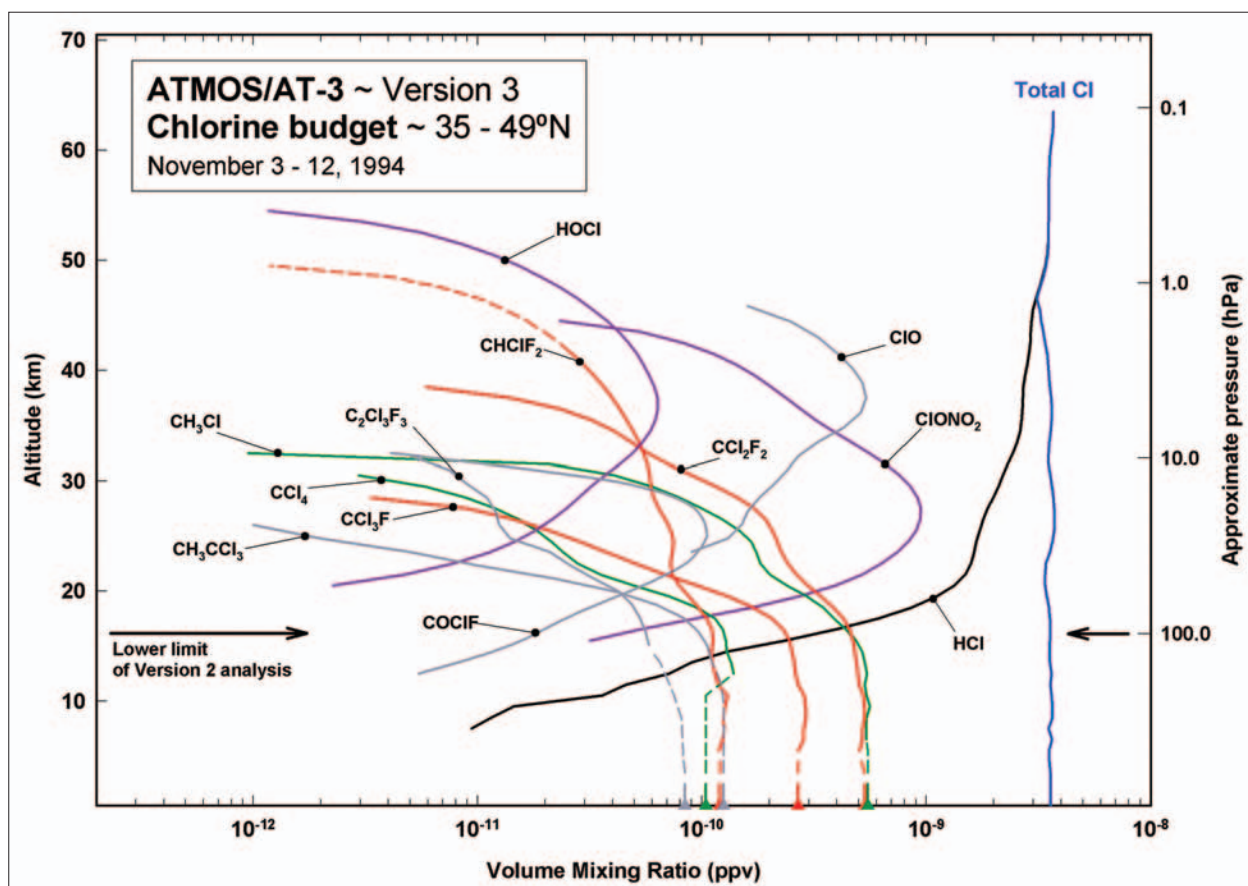

Figure 1.27 - The chlorine budget of the upper troposphere and stratosphere as derived for northern mid-latitudes. It includes all important chlorinated source, sink, and reservoir gases observed by ATMOS during NASA's shuttle mission ATLAS-3 (November 1994) and a few complementary constituents (grey traces) measured by other techniques. Notice the strong similarity (except for  $\text{CCl}_4$ ) between the lowermost volume mixing ratios derived from ATMOS spectra and the corresponding in situ concentrations measured at ground level (triangle symbols) by the NOAA/CMDL network (National Oceanic and Atmospheric Administration / Climate Monitoring and Diagnostics Laboratory). (E. Mahieu, ULg-GIRPAS).

A new ATMOS-like experiment, ACE (Atmospheric Chemistry Experiment), was launched in August 2003 onboard the Canadian Space Agency (CSA) Science Satellite

respect to ATMOS is the additional focus on stratospheric aerosol observations.

### 1.4.3 Has atmospheric research benefited from recent progress in modelling studies?

The answer is yes. Examples of the important role of model studies in understanding and quantifying the relative impacts of various processes in our changing atmosphere have already been presented in previous sections (e.g., 1.1, 1.2). Much progress in the validation of model calculations has been achieved in the last decade through numerous model intercomparisons and further validations with respect to consistent observational databases such as those produced within the context of NDSC-related activities.

The wealth of chemical observations provided by recent, sophisticated multi-payload satellites such as UARS (Upper Atmosphere Research Satellite), ERS-2, ENVISAT, as well as other observing systems, poses new challenges in atmospheric modelling of both the troposphere and the stratosphere. Indeed, the exploitation of such a large quantity of relevant multiple chemical and physical parameters now makes it possible to envisage new promising applications like chemical forecasts and inverse modelling. To these ends, pioneering numerical techniques have been developed at BIRA / IASB, based on the most advanced methods (4-D variational data assimilation with full chemistry). The general idea is to provide the best synthesis of the observations compatible with the model equations. The resulting assimilation analyses are, by construction, the 'best estimates' of the actual composition of the atmosphere.

The Belgian Assimilation System of Chemical Observations from ENVISAT (BASCOE) is an operational service providing chemical analyses from the assimilation of observations made by the dedicated atmospheric chemistry instruments onboard the European satellite ENVISAT. These analyses have the advantage of being as close as possible to real

observations, while still being compatible with the known chemical and transport processes represented in the atmospheric model. From these analyses, high-resolution chemical forecasts can be made. Shown in Figure 1.28 is the prediction of the northern hemisphere total ozone column five days ahead.

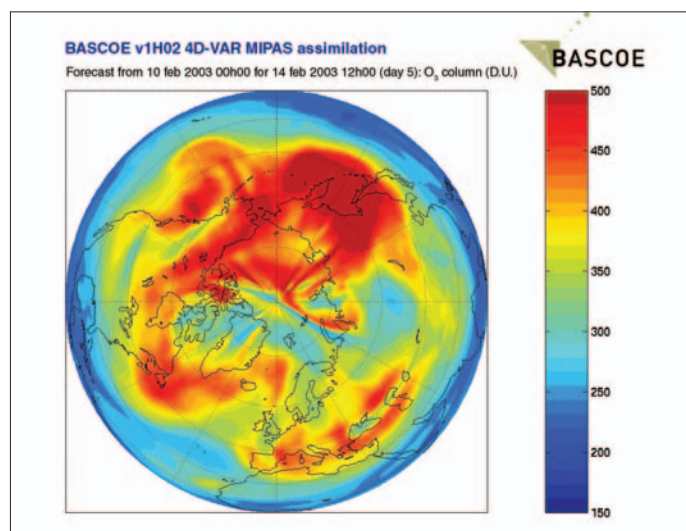

Figure 1.28 - Example of a model prediction of the northern hemisphere total ozone column (in Dobson units, DU) five days ahead, based on ENVISAT satellite observations using BASCOE (Belgian Assimilation System of Chemical Observations from ENVISAT). Subsequent observations have successfully confirmed the predictive approach. (D. Fonteyn, BIRA / IASB).

Similar advanced methods, so-called inverse modelling methods, are also being used to provide improved estimates of surface emissions of tropospheric pollutants, including greenhouse gases and ozone precursors. These estimates rely on the optimal integration of satellite, ground-based, and aircraft observations in the global tropospheric model IMAGES of BIRA / IASB.

### 1.4.4 What original contributions have been made to international atmospheric databases?

To detect changes, one needs some reference. To establish a reference, one must collect a

# Atmospheric Composition Changes

statistically significant set of data. These data must be made available not only to the particular scientific community dealing with the topic, but also to a wider community that may make some other use of the data, possibly at a later time. Therefore, the raw observational data (e.g., atmospheric spectra) and the geophysical results (e.g., time-series of molecular concentrations) must be archived properly; eventually, revised datasets and/or climatology databases may be produced from them.

Numerous BELSPO research projects dealing with atmospheric monitoring from observations and modelling have contributed to the establishment of important data archives. Table 1.1 summarises existing data records obtained by Belgian scientists at various ground-based stations which are all part of the NDSC. The data are archived locally as well as in international databases, after severe quality control and data homogenisation. For example in Brussels-Uccle, the total ozone time-series had

to be corrected for interferences with SO<sub>2</sub> that changed along the time-series and influenced the O<sub>3</sub> trend evaluation. For the ozone profiles, one had to deal with a new correction procedure for the decrease in radiosonde pump efficiency at low pressures and to remove an artificial bias in the time-series at the changeover from one type of sensor to another.

Quality controlled data are submitted to various international databases, such as the NDSC database, the WOUDC (World Ozone and Ultraviolet Radiation Data Centre), and the European NADIR (NILU Atmospheric Database for Interactive Retrieval) and UV databases. They serve various users. For example, they support European field campaigns and are used by satellite validation teams and modellers, for improving satellite data sets and numerical models of the atmosphere, respectively. Ozone profile data are used by ECMWF for their model validation. Well-quantified databases also serve assessment exercises, and thus, indirectly, policy initiatives and decisions.

Table 1.1 Ground-based atmospheric measurement archives from Belgian research institutions within the Network for the Detection of Stratospheric Change (NDSC).

Station	Institute	Instruments	Products	Starting date
Jungfraujoch (Switzerland) 46.5°N, 8°E 3580 masl	BIRA / IASB	UV-Visible zenith-sky spectrometer	Total columns of NO <sub>2</sub> and O <sub>3</sub>	1990
	ULg- GIRPAS	Fourier Transform Infrared spectrometers (FTIR)	Total columns and trends of some 20 atmospheric gases, including O <sub>3</sub> and NO <sub>2</sub>	1984; back to 1950 for some gases
Brussels-Uccle (Belgium) 50.8°N, 4.4°E 100 masl	IRM / KMI	Dobson (Nr. 40)	Total columns of O <sub>3</sub>	1971
		Brewer (Nr. 016 and Nr. 178)	Total O <sub>3</sub> and SO <sub>2</sub> columns; UV-B spectral irradiances and UV index; UV-A spectral irradiances	1983 1989 2001
		Ozone sondes	Vertical profiles of O <sub>3</sub>	1969
	BIRA / IASB	Complete UV monitoring station	UV-A to UV-C spectral irradiances	1993
Harestua (Norway) 60.2°N, 10.8°E 596 masl	BIRA / IASB	UV-Visible zenith-sky spectrometer	Total columns of NO <sub>2</sub> , O <sub>3</sub> , BrO, OClO	1994
Haute-Provence (France) 43.9°N, 5.7°E 684 masl	BIRA / IASB	UV-Visible zenith-sky spectrometer	Total columns of NO <sub>2</sub> , O <sub>3</sub> , BrO, H <sub>2</sub> CO	1998
		UV-Visible multi-axis spectrometer	Tropospheric columns of NO <sub>2</sub> , O <sub>3</sub> , BrO, H <sub>2</sub> CO	2001

Besides the ozone data extending back to 1969, IRM / KMI maintains an even longer time series of pressure-temperature profiles from radiosondes and of synoptic weather observations. The evolutions of annually-averaged surface air temperature and total precipitation in Brussels-Uccle over the period 1833-2002 are displayed, respectively in Figures 2.5 and 2.8.

Processing of satellite data also gives rise to important global datasets. BIRA / IASB has retrieved global BrO data from the GOME instrument on the ESA (European Space Agency) ERS-2 satellite since 1995, and it is extending this dataset with SCIAMACHY observations on ENVISAT. BIRA / IASB has also processed the whole time-series of stratospheric aerosol properties from SAGE-II data (see Figure 1.4). Tropospheric aerosol data sets provided by UGent-INW were used (i) to examine European aerosol phenomenology (activity co-ordinated by JRC-Ispra), and (ii) to carry out a critical review of inorganic bromine in the marine boundary layer (activity co-ordinated at the Max Planck Institute for Chemistry, Mainz, Germany).

The nearly two-decades-long databases assembled at the Jungfraujoch (Switzerland) by ULg-GIRPAS have enabled researchers to produce total column climatologies and long-term trends for many key stratospheric constituents ( $O_3$ , NO,  $NO_2$ ,  $HNO_3$ ,  $ClONO_2$ , HCl, HF and  $COF_2$ ) and for numerous source gases (e.g.,  $CO_2$ ,  $CH_4$ ,  $N_2O$ , CO, COS, HCN,  $C_2H_6$ ,  $C_2H_2$ ,  $CCl_2F_2$ ,  $CHClF_2$ ,  $SF_6$ ) of direct or indirect relevance to both (i) the Montreal Protocol of the Vienna Convention for the Protection of the Ozone Layer and (ii) the Kyoto Protocol of the UNFCCC (United Nations Framework Convention on Climate Change) (see also Chapter 2). Such climatologies are used worldwide in data processing and modelling applications.

#### 1.4.5 How have laboratory studies contributed to databases relevant to atmospheric research?

Atmospheric field research also needs support from fundamental research work. Belgium has contributed significantly to the provision of fundamental laboratory data on spectroscopic parameters for atmospheric gases and of kinetic data on chemical reactions that take place in the lower atmosphere.

##### *Spectroscopic parameters*

A large fraction of atmospheric concentration measurements is derived from observed absorption features (e.g., isolated or aggregated absorption lines) characteristic of each molecule present in the troposphere and the stratosphere. The observations use the sun, the moon, or bright stars as radiation sources. This so-called spectrometric 'remote sensing' approach requires precise knowledge of the spectroscopic absorption parameters of the various target molecules over the wide temperature and pressure ranges encountered in the atmosphere. These parameters are obtained from extensive laboratory work and are assembled in international spectroscopic databases for consistent use in concentration measurements and radiative budget calculations. The most important line parameter compilations are the US HITRAN (High-resolution Transmission molecular absorption database) and the French GEISA (Gestion et Etude des Informations Spectroscopiques Atmosphériques).

Over the last 12 years, ULB-SPECAT, in collaboration with BIRA / IASB and the Université de Reims (France), has extensively contributed to the provision of accurate data in both compilations. Molecules studied in detail include:  $NO_2$ ,  $N_2O_4$ ,  $N_2O$ ,  $O_2$ , COS,  $SO_2$ ,  $C_2H_2$ ,  $C_2H_6$ ,  $H_2O$ , HDO, HOCl, and also 13 chlorofluorocarbons (CFCs),

# Atmospheric Composition Changes

hydrochlorofluorocarbons (HCFCs), and hydrofluorocarbons (HFCs).

An important case demonstrating the need for improved spectroscopic data concerns the water vapour ( $\text{H}_2\text{O}$ ) molecule, which is the strongest atmospheric greenhouse gas, accounting for ~70% of the absorption of the incoming solar light and ~60% of the absorption of the outgoing earth's radiation. So far, modelling of the radiative budget of our planet has remained unsatisfactory, as the models cannot account for the excess (~17%) of atmospheric absorption observed experimentally, a situation known today as the 'Missing Absorber' problem. Among several possible causes, it has been suggested that unsatisfactory knowledge of the absorption properties of  $\text{H}_2\text{O}$  could be responsible for this serious discrepancy. The above-mentioned groups have re-investigated the entire absorption spectrum of  $\text{H}_2\text{O}$ . A portion of the improved spectrum is presented in the top frame of Figure 1.29, showing that the number of observed absorption lines is much larger than in previous studies reported in HITRAN (bottom frame of Figure 1.29), thus accounting for greater absorption of the incoming solar light. This is likely to help solve the 'Missing Absorber' problem.

Another example of original laboratory work carried out at ULB-SPECAT concerns the spectroscopy of CFC substitutes, i.e., HCFCs and HFCs, all of which are strong infrared absorbers in spectral regions otherwise transparent to outgoing radiation, and thus add significantly to the greenhouse effect caused by other, more natural gases such as  $\text{CO}_2$  and  $\text{H}_2\text{O}$ . As the production of all CFCs has been phased out by the Montreal Protocol and its Amendments and Adjustments, their accumulation in the atmosphere has started to level off for some of them (see CFC-12 example in Figure 1.30) or even to decrease

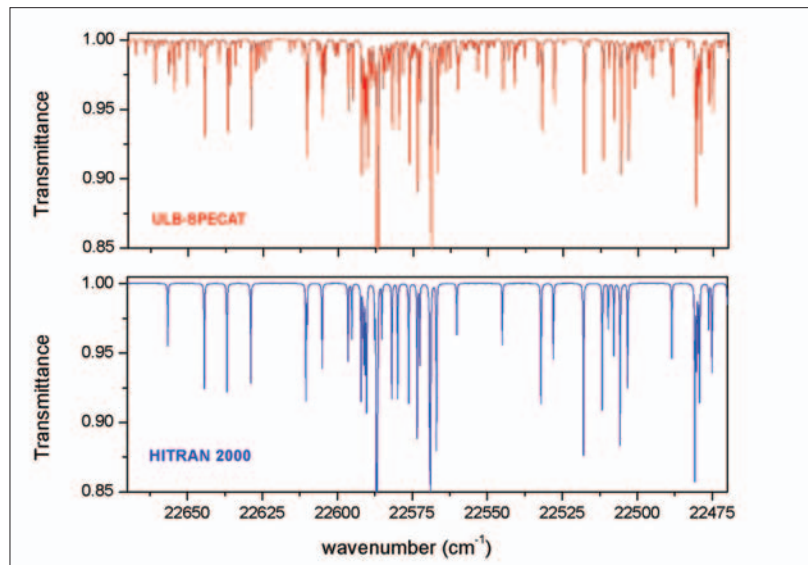

Figure 1.29 - An example of spectroscopic laboratory research in support of atmospheric studies. Many more absorption lines of  $\text{H}_2\text{O}$  have been observed in recent, high-quality laboratory spectra (upper frame) than in those archived in the latest HITRAN database release. Their accounting in radiative model calculations is an important contribution towards solving the so-called 'Missing Absorber' problem. (R. Colin, ULB-SPECAT).

for others (WMO report nr. 47, 2003). This is not yet the case for the HCFCs, whose accumulation continues to increase unabated (see HCFC-22 example in Figure 1.30) until their programmed phasing out goes into force. Additional substitutes are the recently invented HFCs, which are accumulating quite rapidly, in the lower atmosphere. To compare the relative impact of these various radiative-active gases on the climate, a Global Warming Potential (GWP) index has to be determined for each of them. This determination relies on complex atmospheric model calculations involving experimental data, in particular infrared absorption cross-sections for all targeted species. In collaboration with BIRA / IASB, ULB-SPECAT has produced such cross-sections for seven HCFCs and five HFCs, using a high-resolution Fourier transform spectrometer. With help from the NCAR (National Center

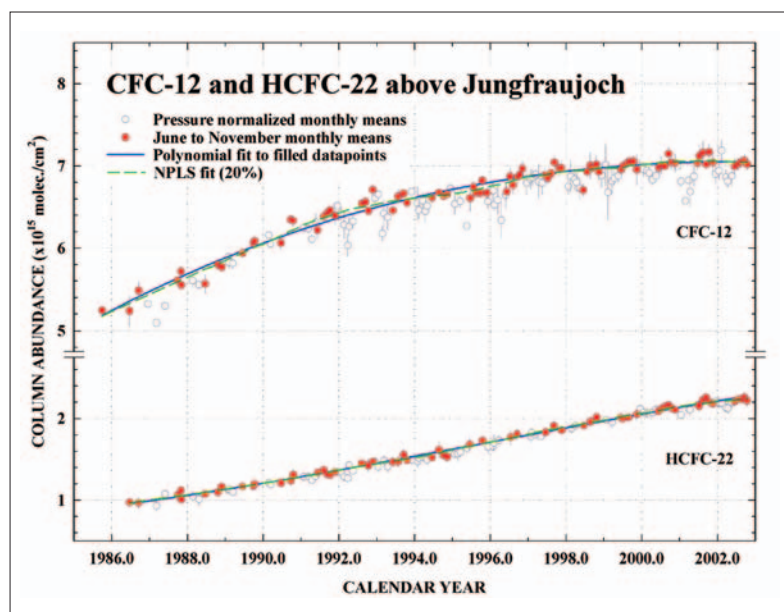

Figure 1.30 - Temporal evolutions of the total column abundances of CFC-12 (regulated) and HCFC-22 (unregulated), as observed above the Jungfraujoch (Switzerland) over the past 17 years. Note the discontinuity in the vertical scale. Continuous and dashed lines (distinguishable for CFC-12 only) represent least square fits to the June-to-November monthly mean columns (filled symbols) only, to avoid significant variability frequently caused by atmospheric transport during winter and spring. (R. Zander, ULg-GIRPAS).

for Atmospheric Research, USA) a radiative-chemical-dynamic-2D interactive model was then used to yield GWP values, calculated relative to CFC-11 for time horizons ranging from 5 to 500 years. Figure 1.31 shows the GWPs as a function of time for the HCFCs investigated at ULB-SPECAT.

The main result is clearly that all the substitutes contribute less (GWPs < 1.0) to long-term global warming than CFC-11, but some are better (lower GWPs) than others. In addition, the findings further show that for short-time horizons (<20 years), some HCFCs contribute to global warming nearly as strongly as CFC-11 (GWP $\approx$ 1). These conclusions have been reported in WMO-UNEP Assessments (e.g., WMO report nr. 44, 1999) and used

extensively since the mid-1990s, in particular for worldwide environmental policy decisions made at recent Montreal Protocol amendment- and-adjustment meetings.

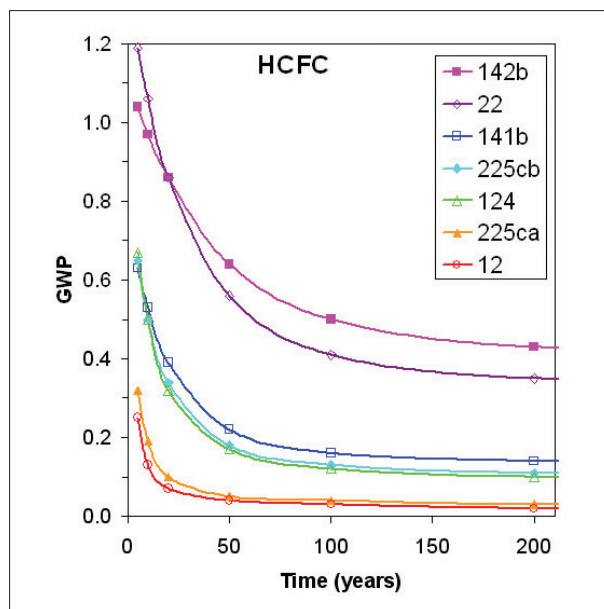

Figure 1.31 - Time evolution of global warming potentials (GWPs) relative to CFC-11, for seven important HCFCs used as substitutes for the CFCs banned by the Montreal Protocol and its Amendments and Adjustments. (R. Colin, ULB-SPECAT).

### Kinetic parameters

The Belgian contributions to the provision of kinetic and mechanistic data concerning chemical reactions in the troposphere, in particular those governing the formation and fate of tropospheric ozone, have largely been developed at KULeuven-PAC, initially as contributions to the EUROTRAC project LACTOZ (Laboratory Studies of Chemistry Related to Tropospheric Ozone). Subsequently, they have been pursued within a collaborative effort with BIRA / IASB in order to develop approaches making it possible to implement them in tropospheric chemistry-transport models (examples of applications are given in Section 1.2.5). In particular, the results of the experimental laboratory and theoretical work on the OH-initiated oxidation of volatile organic

# Atmospheric Composition Changes

compounds conducted at KULeuven-PAC have been integrated into the chemical mechanism database of EUROTRAC. In addition, theoretical mechanistic data from KULeuven-PAC, including Structure-Activity Relationships, have been incorporated into the benchmark Master Chemical Mechanism VOC-oxidation database of the University of Leeds, UK. In this way, KULeuven-PAC results contribute to refining model predictions on the impact of policy measures in Europe.

## 1.5 Concluding remarks

Since the middle of the 20<sup>th</sup> century, Belgium has made substantial, often pioneering contributions to atmospheric science research. Following the discovery of the stratospheric ozone hole over Antarctica in the early 1980s, the European scientific community and policymakers became concerned that the ozone layer might similarly erode at highly populated northern hemisphere mid- and high latitudes. Quasi simultaneously, quantitative links between changes in global atmospheric composition and climate also became evident, with potentially important socio-economic consequences. This implied sounding both the troposphere and the stratosphere for their gaseous and particulate compositions. The 1985 'Vienna Convention for the Protection of the Ozone Layer' and the 1992 'United Nations Framework Convention on Climate Change' (UNFCCC) were established by the United Nations to harmonise and coordinate related efforts at the national and international levels. Belgium was among the first parties to endorse and sign these conventions, and compliant with European Union policies, it established a national, multi-disciplinary 'Global Change' research programme which began in 1990.

Within this context, numerous Belgian groups have made substantial contributions to quantifying the temporal evolution of the

atmospheric composition, primarily at northern mid-latitudes (including Belgium), and to identifying the causes and processes involved. Original efforts have dealt with: monitoring and understanding the erosion of the protective ozone layer in the stratosphere (BIRA / IASB, IRM / KMI, ULg-GIRPAS); quantifying changes in numerous tropospheric source gases and particulate aerosol matter that contribute, directly or indirectly, to stratospheric ozone depletion, tropospheric ozone production, climate change, and threats to human health (BIRA / IASB, IRM / KMI, UA-MiTAC and UA-Phar, UGent-INW, ULB, ULg-GIRPAS, VITO-TAP). With the help of increasingly complex model simulations developed by BIRA / IASB and VITO-TAP, various atmospheric processes have been progressively understood and quantified.

Regarding stratospheric ozone layer depletion, it has now been concluded unequivocally that the major causes are linked to human activities, and particularly, in past decades, to the intensive use and release into the atmosphere of anthropogenic chlorine- and bromine-bearing source gases such as the long-lived CFCs, HCFCs, and halons. After diffusing in the stratosphere, these constituents undergo photochemical decomposition and heterogeneous transformations that free ozone-destroying chlorine and bromine atoms (ULg-GIRPAS, BIRA / IASB). It was further shown that major natural events such as intensive volcanic eruptions (e.g., El Chichón, Mexico, in 1982; and Mount Pinatubo, Philippines, in 1991) have only a small impact on stratospheric inorganic halogen loading (ULg-GIRPAS, BIRA / IASB). However, they inject large quantities of SO<sub>2</sub> into the stratosphere, ultimately turning into sub-micrometric aerosol droplets containing a mixture of water and sulphuric acid. As observed in Brussels-Uccle and at the Jungfrauoch (Switzerland), these affect the

stratospheric ozone layer and NO<sub>2</sub> loading over a couple of subsequent years through enhanced heterogeneous chemistry processes (BIRA / IASB, IRM / KMI, ULg-GIRPAS).

As a consequence of stratospheric ozone layer depletion, harmful UV radiation has increased at ground level, raising concerns about an increased incidence and severity of health effects such as cataract and skin cancer. This anti-correlation has been quantified in Brussels-Uccle since 1993 (IRM / KMI, BIRA / IASB). A standard UV index is currently predicted and reported for Belgium along with 'next day' weather forecasts (IRM / KMI). This UV index is a calculation of the erythema risk for human skin during excessive exposure to the sun.

The amended 1987 Montreal Protocol has progressively phased out the production of all anthropogenic source gases which indirectly erode the ozone layer. Consequently, the total combined effective abundance of ozone-depleting compounds in the troposphere (expressed in terms of the sum of organic chlorine and bromine in all halogenated source gases) reached a peak in 1992-1994, and since, has been declining very slowly in the lower atmosphere. The resulting propagation at higher altitudes has been the stabilisation of inorganic chlorine loading in the stratosphere in 1997-1998 (ULg-GIRPAS). However, the inorganic bromine load is still increasing (owing to the use of large stocks of bromine-containing source gases as forest fire extinguishing agents), but at a slower rate than previously (BIRA / IASB). Current model calculations (which take into account chemistry, transport, field observations, compliance with the Montreal Protocol and related scenarios...) predict that the ozone layer will progressively return to its pre-ozone-hole level within the coming 50 years. While this prediction remains to be confirmed through continued field measurements, the

Vienna Convention and the ensuing Montreal Protocol can already be considered a successful example of comprehensive synergy between scientists and decision-makers. Scientists have regularly produced international scientific assessments on the state of the stratospheric ozone layer and decision-makers have produced amendments and adjustments to the protocol based on scientific advances. Belgium (ULg-GIRPAS, BIRA / IASB, IRM / KMI) has played a key role in this chain of events.

Whilst the stratospheric ozone layer has eroded since the mid-1980s, tropospheric ozone has increased, along with other photo-oxidants, many source gases, and suspended particulate matter. This has led to concerns about alterations of land and sea ecosystems, climate impacts, and human health hazards. In this complex context, BIRA / IASB, IRM / KMI, KULeuven-PAC, and VITO-TAP have contributed to significant advances in both monitoring and modelling the temporal evolution of tropospheric ozone and its precursor gases. The most important of these gases are VOCs and NO<sub>x</sub>, whose main anthropogenic sources are road traffic, industrial activities, and biogenic emissions. This research has been undertaken in the framework of federal plans supporting both EU and UN protocols such as CAFE and CLRTAP. The increase in tropospheric ozone concentrations over many northern mid-latitude areas has slowed in recent years, as expected from the VOC and NO<sub>x</sub> emission regulations (BIRA / IASB, KULeuven-PAC, VITO-TAP). Nevertheless, global precursor emission scenarios assimilated into model calculations in which BIRA / IASB has participated, predict large tropospheric ozone increases in developing countries in the 21<sup>st</sup> century, with likely global environmental consequences. Model calculations have also shown that the reduction in VOC emissions is consistent with the observed drop in peak ozone concentrations



# Atmospheric Composition Changes

(VITO-TAP). Both Europe- and Belgium-specific models have been further developed in a collaborative effort between KNMI (The Netherlands), VITO-TAP, and CELINE-IRCEL as tools for policy support in the field of tropospheric ozone. The performance of these models has benefited from both laboratory and theoretical studies carried out in synergy at KULeuven-PAC and BIRA / IASB in the framework of EUROTRAC and EUROTRAC-2 projects. In this context, further improvements are expected from consistent applications of a recent innovative approach at KULeuven-PAC, in which the reactions of highly reactive radical intermediates involved in the oxidation of a given VOC are fully characterised theoretically. Along with various other mechanistic oxidation data under scrutiny, this novel approach will significantly refine model predictions of tropospheric ozone production from many VOCs and NVOCs, the latter remaining, however, poorly quantified at this time.

Tropospheric aerosols, i.e., populations of tiny liquid or solid particles suspended in air, originate from a wide variety of natural as well as anthropogenic sources. Examples are sea salt, soil dust, and volcanoes on the one hand, and road traffic, industrial, combustion, and biomass-burning emissions on the other hand. Without much doubt, it can be said that aerosols have numerous adverse effects on the environment via heterogeneous chemistry and climate impacts, and on human health via acute breathing difficulties and cardiovascular stresses (UA-MiTAC). As aerosol sources of human origin have increased substantially in the 20<sup>th</sup> century, important efforts have been undertaken at the European level to better characterise their physical and chemical properties, to identify and quantify their sources, to study their transport, and to develop mitigation strategies. Related research activities have been carried out by Belgian teams at UGent-INW and UA-Phar over

various parts of the world, in the framework of EUROTRAC, EUROTRAC-2, and other international programmes and campaigns. Based on chemical and microphysical analyses of tropospheric aerosols consistently collected during the last decade at urban and rural sites in Belgium and at natural background sites in Scandinavia, UGent-INW and UA-Phar have been able to perform aerosol chemical mass closure determinations. Mass closure is achieved when the concentrations of the individually measured components add up to the directly measured total mass concentration. On the basis of temporal extrapolations of these datasets, concern has further been expressed about Belgium not meeting EU-2010 standards for suspended particulate matter levels at most near-city, urban background, and kerbside sites. As pointed out in IPCC TAR, both direct and indirect effects on climate of various types of aerosols remain highly uncertain, and efforts need to be pursued and intensified in order to reduce related knowledge gaps. Current levels of suspended particulate matter in ambient tropospheric air also remain an acute concern from a human health standpoint (UA-MiTAC). As people spend around 80% of their time indoors, it has been recommended that relevant air studies include indoor air pollution, where major aerosol contributors to poor air quality are tobacco smoke and domestic solvents.

Among the important challenges that the atmospheric science community currently faces are certainly the temporal and spatial scale problems, i.e., integrating past and present evolutions in order to properly predict a sustainable future from the local to the global scale. Consequently, it is increasingly obvious that atmospheric research activities have to be planned with strong interactions and synergies between measurements, model simulations, and predictions, and international policy assessments.

Related developments to which Belgium (BIRA / IASB, ULg-GIRPAS, IRM / KMI, UGent-INW) has contributed, both managerially and scientifically, include: (i) coordinating and conducting long-term ground-based observation activities within the context of the WMO-GAW and NDSC; (ii) involvement in designing and characterising space-based experiments and participation in international calibration/validation campaigns and in data analyses of satellite observations of the atmosphere; (iii) synergistic exploitation of ground-based, balloon, aircraft, and satellite datasets through numerical model simulations, and implementation of these simulations for chemical forecasts and inverse modelling; (iv) developing composite profile and total-column climatologies for well over two dozen key atmospheric source, sink, and reservoir constituents of relevance to the Montreal and/or Kyoto Protocol; (v) producing and maintaining quality-controlled geophysical databases regarding gaseous and aerosol constituents of the atmosphere, and their archiving at facilities easily accessible to the scientific community. These databases are used worldwide in atmospheric chemistry modelling applications and in radiative budget calculations for climate-related studies.

Last to be mentioned here, but not least in importance, is original Belgian laboratory research conducted in support of atmospheric science applications reported in this chapter. This concerns the production of kinetic and mechanistic data on chemical reactions influencing the oxidation capacity of the troposphere and thus ozone formation in the lower atmosphere (KULeuven-PAC, BIRA / IASB), already mentioned. In collaboration with BIRA / IASB and the University of Reims (France), ULB-SPECAT has been very active in the production of new, more complete and accurate spectroscopic parameters needed to interpret remote optical observations from

aboard ground-, air- and space-based platforms. More than two dozen molecules have been analysed over wide temperature and pressure ranges encountered in the atmosphere, and their parameters have been archived in two international spectroscopic compilations used by the scientific community worldwide. They are also of prime relevance in climate-related radiative budget calculations. The list of gases investigated includes HCFCs and HFCs used as substitutes for the banned CFCs. With the help of model calculations performed in collaboration with scientists from NCAR (USA), the Global Warming Potentials of these substitutes have been calculated for time horizons ranging from 5 to 500 years.

## 2. Climate change



### 2.1 How is the earth's climate changing now?

#### 2.1.1 Introduction

Climate in a narrow sense is usually defined as the 'average weather' or more rigorously as the statistical description, in terms of the mean and variability of relevant quantities, such as temperature, precipitation, and wind, over a period of time ranging from months to thousands or millions of years. The classical period is 30 years. Climate in a broader sense is the state of the climate system as a whole, including a statistical description of its variations.

The climate system is a highly complex system consisting of five major components: atmosphere, hydrosphere, cryosphere, land surface, and biosphere, plus the interactions between them (Figure 2.1). The climate system evolves in time under the influence of its own internal dynamics and because of external forcings such as volcanic eruptions, solar variations, and anthropogenic forcings.

Although the components of the climate system are very different in their composition, physical and chemical properties, structure, and behaviour, they are all linked by fluxes of mass, heat, and momentum: all subsystems are open and interrelated. For example, the atmosphere and oceans are strongly coupled and exchange, among others, water vapour and heat through evaporation. This is part of the hydrological cycle and leads to condensation, cloud formation, precipitation, and runoff, and supplies energy to weather systems. On the other hand, precipitation has an influence on salinity, its distribution, and the large-scale density-driven circulation in the ocean, called the thermohaline circulation. Atmosphere and oceans also exchange carbon dioxide, among other gases, maintaining a balance by dissolving it in cold polar water that sinks into the deep ocean and by releasing it in relatively warm upwelling water near the equator.

Climate change refers to any change in climate over time, whether due to natural

variability or human activity. It is characterised by statistically significant variations that persist for an extended period, typically decades or longer. This includes changes in climatic averages, such as slow, continuous rise in global mean surface temperature, as well as changes in climatic variability, such as frequency and magnitude of sporadic weather events. Changes in variability may occur at several time and spatial scales (e.g., anomalous warming of the central and eastern equatorial Pacific).

It is a fact that the earth's climate is in the process of changing. A series of observations support this conclusion and provide insight into the rapidity of these changes.

An increasing body of observations gives a collective picture of a warming world and other changes in the climate system:

- ✓ The global average surface temperature has increased over the 20<sup>th</sup> century by about 0.6°C. The 1990's are likely to have been the warmest decade of the last millennium in the northern hemisphere and 1998 is likely to have been the warmest year.
- ✓ Temperatures have risen by 0.1°C per decade over the past four decades in the lowest 8 km of the atmosphere.
- ✓ Annual land precipitation has increased in much of the northern hemisphere by 0.5 to 1% per decade.
- ✓ Snow cover and ice extent have decreased by about 10% since the late 1960's, and there has been a widespread retreat of mountain glaciers in non-polar regions in the 20<sup>th</sup> century. There is a highly significant correlation between increases in northern hemisphere land temperatures and decreases in snow cover and land- and

sea-ice extent.

- ✓ The global average sea level has risen by between 0.1 and 0.2 m in the 20<sup>th</sup> century and ocean heat content has increased.
- ✓ Other important changes have also occurred:
  - an increase (2 to 4%) in the frequency of heavy precipitation events in many mid- and high latitudes of the northern hemisphere over the second half of the 20<sup>th</sup> century;
  - a change in the frequency of extreme events, e.g. hot, cold, and frost days;
  - an increase in cloud cover over mid- to high-latitude land areas;
  - more frequent, persistent, and intense warm episodes of the El Niño phenomenon.

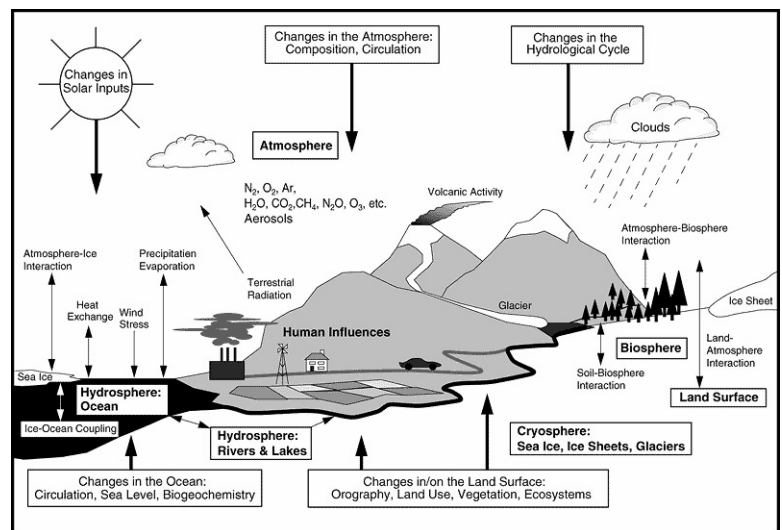

Figure 2.1 - Schematic view of the components of the global climate system (bold text in boxes), their processes and interactions (thin arrows), and some aspects that may change (bold arrows). (IPCC TAR - Climate Change 2001: The Scientific Basis).

## 2.1.2 Temperature

Temperature increase is at the core of global warming. Figure 2.2 shows the variety of temperature indicators supporting the collective picture of a warming world. It is likely that the rate and duration of the warming of the 20<sup>th</sup> century are greater than at any other time in the

last 1,000 years. The 1990's are likely to have been the warmest decade of the millennium in the northern hemisphere, and 1998 is likely to have been the warmest year. Most of the increase in global temperature since the late 19<sup>th</sup> century has occurred in two distinct periods: 1910 to 1945 and since 1976, at a rate of about 0.15°C/decade, as shown in Figure 2.3.

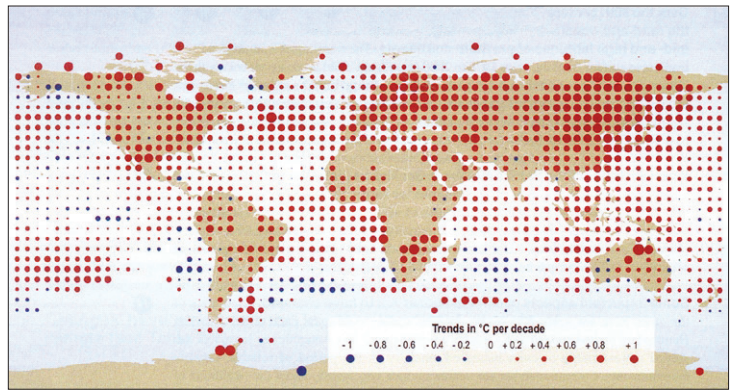

Figure 2.4 – Annual temperature trends: 1976-2000. Consistent, large-scale warming of both the land and ocean surfaces occurred over the last quarter of the 20<sup>th</sup> century. (IPCC TAR - Climate Change 2001: Synthesis Report).

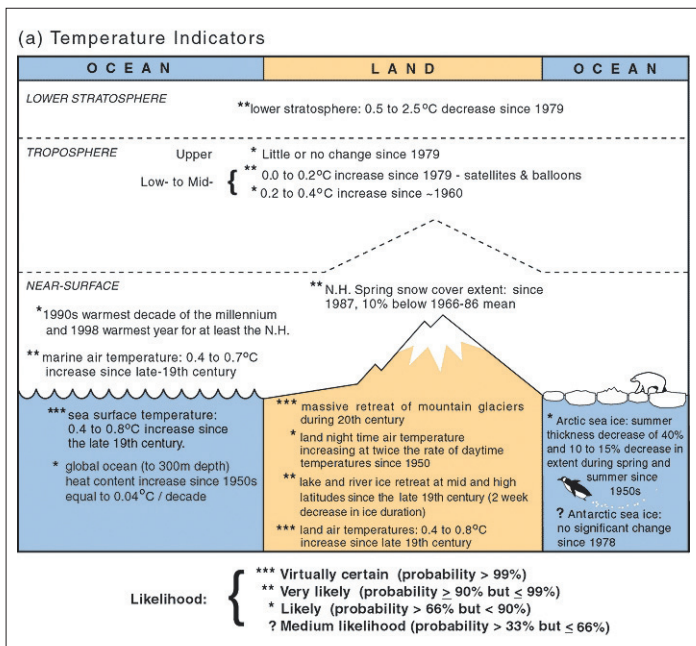

Figure 2.2 - Schematic representation of observed variations of temperature indicators. (IPCC TAR - Climate Change 2001: The Scientific Basis).

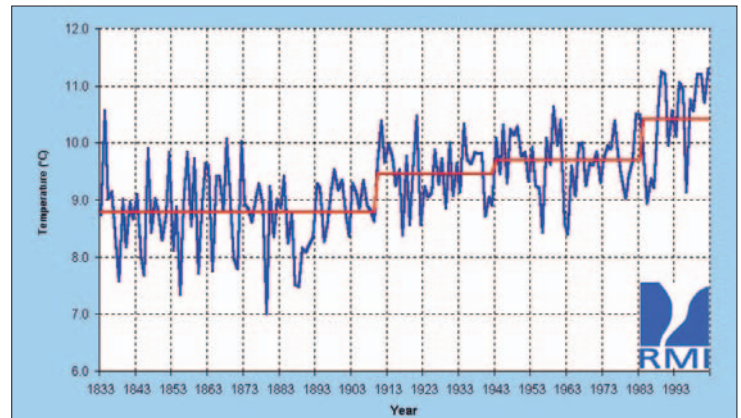

Figure 2.5 - Annually averaged surface air temperature at Brussels-Uccle over the period 1833-2002. The mean temperature has increased by 1 to 2°C over the last 170 years. This warming was not continuous but occurred in steps, mainly around 1910 and 1985. The blue curve shows the annually averaged temperature and the horizontal red lines represent the averaged values of temperature for periods during which the temperature did not show any (statistical) trend. The station was located near the centre of Brussels up to 1890 and was moved at that time to Uccle in the outskirts of Brussels. Between 1886 and 1890, measurements at both locations were undertaken in parallel and the systematic bias in temperature between the two sites has been taken into account to obtain a homogenised annual time series. (IRM / KMI).

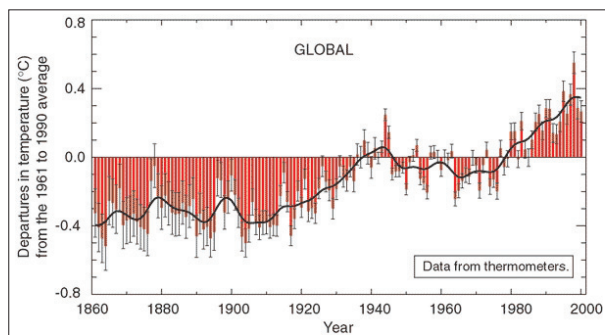

Figure 2.3 - Combined annual land-surface, air, and sea-surface temperature anomalies (°C) from 1861 to 2000, relative to 1961 to 1990. Two standard error uncertainties are shown as bars on the annual number. (IPCC TAR - Climate Change 2001: The Scientific Basis).

The high global temperature associated with the 1997 to 1998 El Niño event stands out as

an extreme event, even taking into account the recent rate of warming.

Global patterns of warming are not spatially and temporally uniform. For example, the most recent period of warming (1976 to 1999) has been almost global, but the largest increases in temperature have occurred over the mid- and high latitudes of the continents in the northern hemisphere (see Figure 2.4).

Regional temperature trends over a few decades can be strongly influenced by regional variability in the climate system and can depart appreciably from a global average (see Figure 2.5).

### 2.1.3 Precipitation and atmospheric moisture

Many indicators relate to the global water cycle change as well (see Figure 2.6). It is likely that total atmospheric water vapour has increased by several percent per decade over many regions of the northern hemisphere since the early 1970s, with the consequence that the troposphere contains more water that can fall as rain. This is consistent with the increase in total cloud cover of about 2% observed since

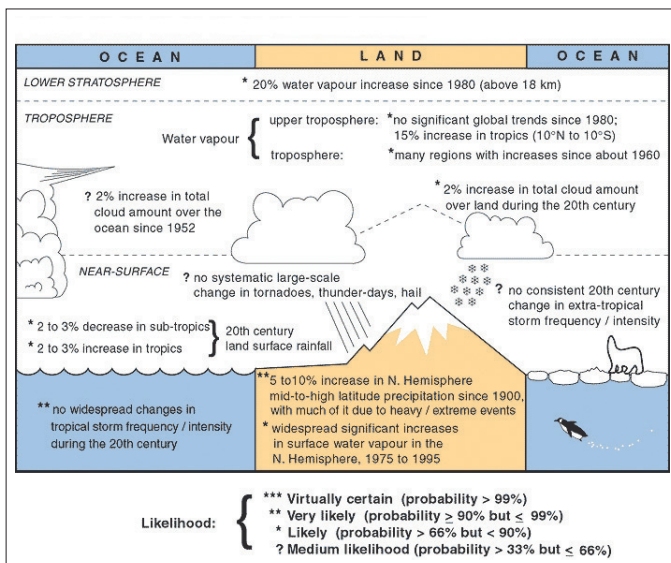

Figure 2.6 - Schematic representation of observed variations of hydrological and storm-related indicators. (IPCC TAR - Climate Change 2001: The Scientific Basis).

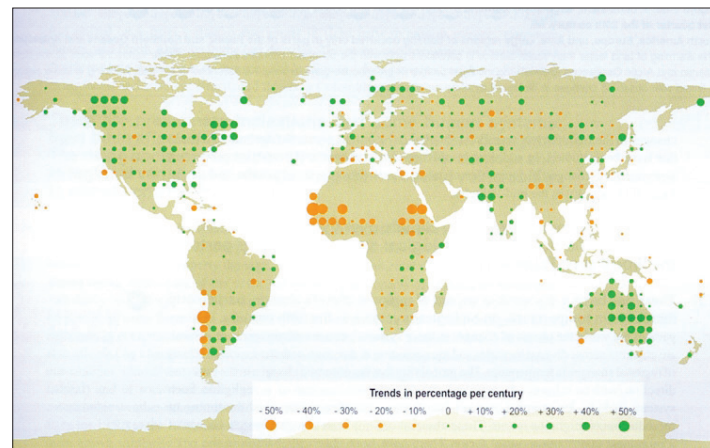

Figure 2.7 - Annual precipitation trends: 1900-2000. Over the 20<sup>th</sup> century, precipitation has increased, on the average, over continents outside the tropics but decreased in desert regions of Africa and South America. (IPCC TAR - Climate Change 2001: The Scientific Basis, 2001).

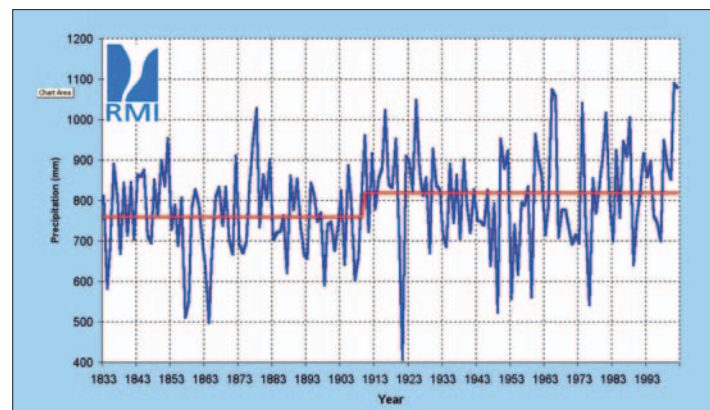

Figure 2.8 – Evolution of the annually averaged total precipitation at Brussels-Uccle over the period 1833-2002. In Brussels-Uccle, mean precipitation has increased by about 50 mm over the last 170 years. The increase was not continuous but was characterised by a step around 1910. The blue curve shows the annually averaged total precipitation, and the horizontal red line represents the averaged precipitation values for periods during which precipitation showed no (statistical) trend. The series was homogenised (see Figure 2.5) (IRM / KMI).

the beginning of the 20<sup>th</sup> century over many mid- to high-latitude land areas.

It is very likely that precipitation has increased by 0.5 to 1% per decade in the 20<sup>th</sup> century over most mid- and high latitudes of

the northern hemisphere continents, except over Eastern Asia. Over the sub-tropics (10°N to 30°N), land-surface rainfall has decreased on average (it is likely to be about 0.3% per decade), although it has shown signs of recovery in recent years. Tropical land-surface precipitation measurements indicate that precipitation has likely increased by about 0.2 to 0.3% per decade over the 20<sup>th</sup> century, but increases are not evident over the past few decades and the amount of tropical land (versus ocean) area for the latitudes 10°N to 10°S is relatively small (see Figure 2.7). Marked increases in precipitation have been observed over northern Europe, with a general decrease southward to the Mediterranean Sea. Belgium, being in the middle, is relatively unaffected by these trends up to now (see Figure 2.8).

### 2.1.4 Sea level

Based on geological data, it appears that the global average sea level has risen at an average rate of 1-2 cm per century over the last 3,000 years. Based on tide gauge data, the rate of global sea level rise over the 20<sup>th</sup> century was between 10 and 20 cm per century. The main factors affecting sea level are changes in water density and in the total mass of the ocean.

Water expands, and its density decreases as the ocean warms. Recent studies have shown that in 1998, the upper 300 m of the world ocean contained more heat than it did in the mid 1950s. This additional heat represents a warming of that layer by 0.15 to 0.45°C.

Changes in the total mass of the ocean are mainly due to melting of ice in glaciers or ice sheets. For example, total melting of the Antarctic or Greenland ice sheet would raise the global sea by 60 m or 7 m respectively. Although it is very unlikely that this will happen any time soon, it is clear that even small fractional changes in ice volume would have major consequences. Despite recent advances in the understanding

of polar ice sheets, their current mass balance is not yet known with any precision. The melting of all other mountain glaciers and small ice caps would raise the global sea level by 0.5 m.

There is now ample evidence of a major retreat of alpine and continental glaciers. There is a consensus that the global glacier volume has substantially decreased since its high stand in the mid-19<sup>th</sup> century. To evaluate the contribution of this phenomenon to global sea level change, we need to know the rate of change of total glacier mass. Unfortunately, sufficient measurements exist only for a small minority of the world's 100,000 glaciers. Therefore, the volume loss has to be estimated from global algorithms. Current estimates place the average sea level contribution from glaciers and ice caps in the 20<sup>th</sup> century between 0.2 and 0.4 mm/yr.

For example, major glaciers in Central Asia (Altai Mountains, South Siberia, Russia), seem highly vulnerable to climate change and display a sustained retreat (Figure 2.9). Numerical model experiments, for instance, show that most of these glaciers will have almost disappeared by the end of the 21<sup>st</sup> century.

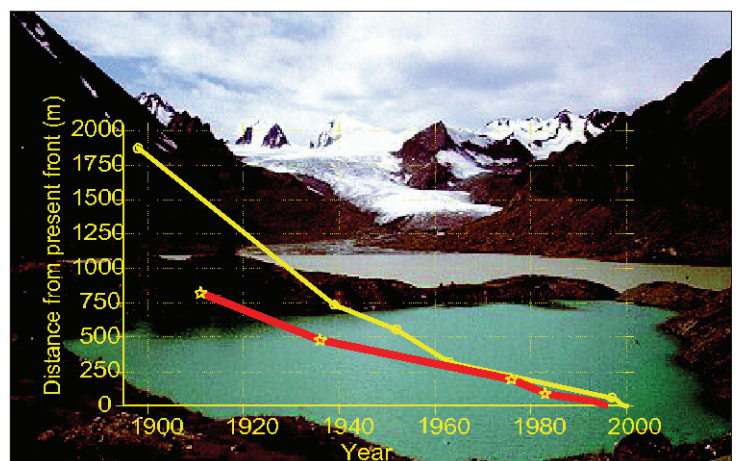

Figure 2.9 - Retreat history of two major glaciers in the Altai Mountains, South Siberia (Russia). The yellow line stands for the Sofiyskiy Glacier, the red one for the Maliy Aktru Glacier. The picture in the back shows the tongue of the Sofiyskiy Glacier in 1998. The photograph is taken at the position of the glacier front in 1898. (VUB-DG, 2003).

### 2.1.5 Sea ice

Sea ice is frozen seawater. It covers most of the polar oceans, especially in winter. The typical thickness of sea ice is 3 m in the Arctic Ocean and 1 m in the Southern Ocean. Sea ice is expected to become a sensitive indicator of a warming climate. Considerable reductions in sea-ice thickness and extension have been recorded in the Arctic (see Figure 2.10). This situation has been revealed only recently thanks to the release of US submarine upward-looking sonar data from the cold war period. The great variability of the data is still debated: the question is whether it results from natural fluctuations of a weather pattern called the North Atlantic Oscillation (NAO) or from a definite trend linked to the anthropogenic impact on climate (although the latter impact might also affect the NAO).

A simulation has been conducted with the

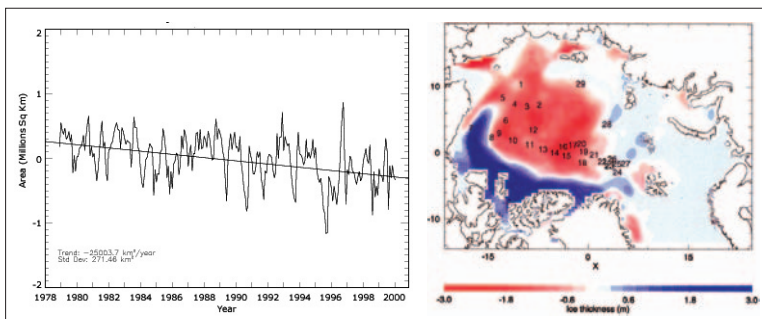

Figure 2.10 - Records of the reduction in sea-ice surface (l) and thickness (r) in the Arctic Ocean over the last decades. The figure to the left shows the trend of sea-ice extent anomalies since 1978. Although there is high variability over a relatively short observation period, the trend is a steady decrease of about 25,000 km<sup>2</sup> (nearly the surface of Belgium)/yr. The figure to the right shows the difference in September ice thickness between later years (1993, 1996, 1997) and earlier years (1958, 1960, 1962, 1970, 1976) in an ice-ocean model. The numbers on the map correspond to locations where ice thickness has been measured. Using data acquired on submarine cruises, it has been determined that the mean sea-ice draft at the end of the melt season in the Arctic has decreased by about 1.3 m over the past 30 to 40 years. (ULB-GLACIOL).

CLIO model (Coupled Large-scale Ice Ocean), a global sea-ice–ocean model forced with daily surface air temperatures and winds in order to document the variability of the Arctic and Antarctic sea-ice covers over the period 1955–2001. The model reproduces reasonably well the mean state and variability of the Arctic and Antarctic ice packs over the satellite observation era, and this with the same set of parameter values for both hemispheres. The simulation has revealed decadal variations in ice area along with downward trends of about 1% per decade in both hemispheres over the period 1955–2001 (see Figure 2.11).

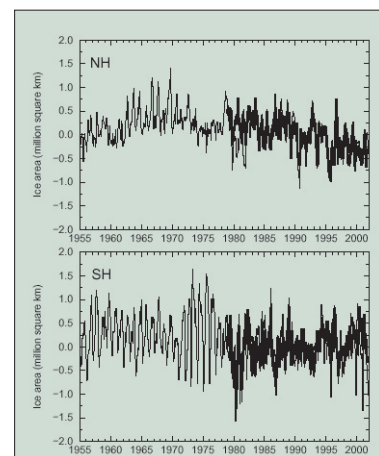

Figure 2.11 - Time series of monthly ice volume anomaly as simulated by the CLIO model (Coupled Large-scale Ice Ocean) for the northern hemisphere (top) and the southern hemisphere (bottom). In the southern hemisphere, the trend results mainly from retreat of the ice pack in the second half of the 1970's and the early 1980's, leading to a loss of ice cover of 300,000 km<sup>2</sup> (10 times Belgium) between 1955–1976 and 1982–2001. (UCL-ASTR).

### 2.1.6 Tropical regions

Effects of global warming are also perceptible in tropical regions. In recent decades, a warming of about 0.7 to 0.9°C was observed by Belgian scientists in the air temperature at Bujumbura and Mbala, the northernmost and southernmost parts of Lake Tanganyika in East Africa (Figure



2.12). Besides this impact of global warming, a significant correlation was found over the recent period between the El Niño Southern Oscillation (ENSO) and higher air temperature (0.28 °C average, 0.8 °C maximum), higher radiation, higher atmospheric pressure, and lower wind speed in the Lake Tanganyika area. Because of the impact on the thermal stratification of this lake, higher air temperature and radiation and lower wind speed would imply that the lake is much less dynamic during an El Niño year. A preliminary study has quantified the probable theoretical impact of El Niño and temperature changes on the stability of the lake. Partially linked to ENSO conditions, results for the last 40 years suggest that the stability of the lake (upper 100 m) had a 20% variability range over this period (correlating positively with Pacific Ocean sea surface temperature anomalies) (Figure 2.13). This figure might possibly be higher if more wind data were available. This

implies less mixing of nutrient-rich deep water and, most probably, decreased productivity of the lake. This observation might be extended to other comparable aquatic ecosystems.

Tropical regions can also provide evidence of increasing anthropogenic emissions of CO<sub>2</sub> (carbon dioxide), thanks to the analysis of the δ<sup>13</sup>C concentration (abundance of the carbon isotope 13) in the calcareous skeleton of a unique group of tropical sponges (sclerosponges). Fossil

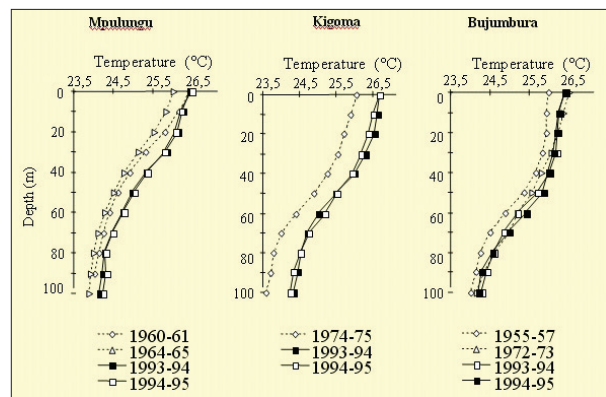

Figure 2.13 - Changes in water temperature at three stations in Lake Tanganyika, East Africa, from 1955 to 1995. (UGent-PAE, KMMA / MRAC, UCL-ASTR, FUNDP-URBO, 2000).

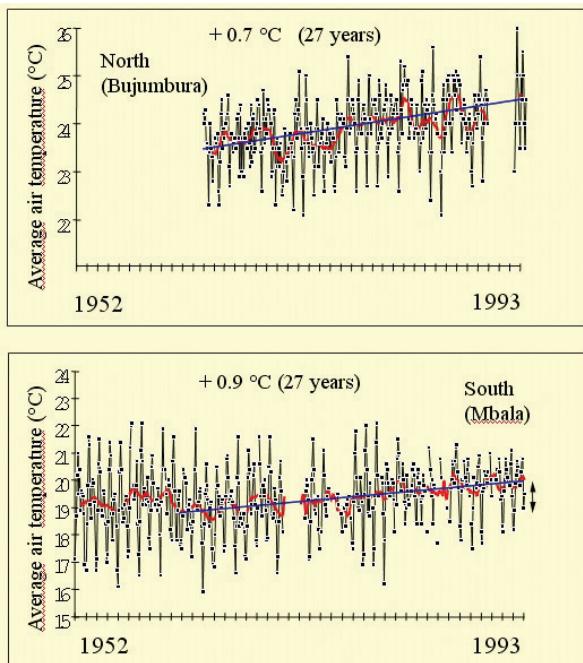

Figure 2.12 - Changes in monthly average air temperature at Bujumbura, Lake Tanganyika, East Africa, from 1963 to 1993. Regression is calculated for the period 1964 to 1990. (UGent-PAE, KMMA / MRAC, UCL-ASTR, FUNDP-URBO, 2000).

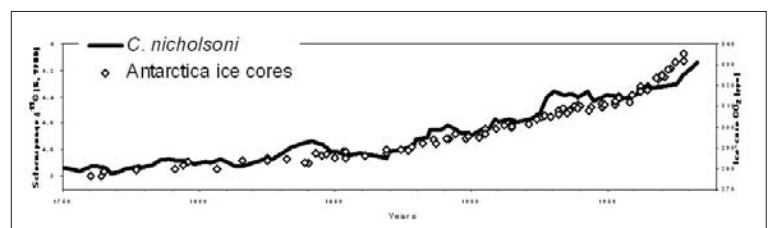

Figure 2.14 - The δ<sup>13</sup>C (abundance of the carbon isotope 13) profile of a specimen of the reef-building sclerosponge *Ceratoporella nicholsoni* collected in the Bahamas in 1985 displays a severe decrease in the recent layers of the skeleton (1860-1984). This decrease has been related to the increase of fossil fuel combustion and deforestation since pre-industrial time. The resulting dramatic increase in atmospheric CO<sub>2</sub> has gone with <sup>13</sup>C depletion. The δ<sup>13</sup>C of *Ceratoporella nicholsoni* is compared to the CO<sub>2</sub> content in Antarctic ice core air bubbles reported by Murozumi et al. (1969). The shapes of the two curves are very similar. (IRSNB / KBIN,

fuels are poor in carbon-13, and the atmospheric abundance of this isotope therefore correlates inversely with the CO<sub>2</sub> concentration. The profile of the δ<sup>13</sup>C concentration along the growth axis displays a decrease related to the increase of fossil fuel combustion and deforestation (see Figure 2.14).

## 2.2 Is present climate change different from past climate change?

### 2.2.1 Introduction

To determine whether 20<sup>th</sup> century warming is unusual, it is essential to place it in the context of longer-term climate variability. Owing to the sparseness of instrumental climate records prior to the 20<sup>th</sup> century (especially prior to the mid-19<sup>th</sup> century), estimates of global climate variability in past centuries must often rely upon indirect indicators, such as natural or human documentary archives, but these must be calibrated against instrumental data for an appropriate climate interpretation.

The past 1,000 years are a particularly important time frame for assessing the background natural variability of the climate for climate change detection. Astronomical boundary conditions have strayed relatively little from their modern-day values over this interval and the spatial extent of large-scale climate change over the past millennium can now be meaningfully characterised. Moreover, estimates of volcanic and solar climate forcings are also possible over this period, allowing model-based estimates of their climate effects.

Reconstruction of palaeoclimates is done based on analyses of different properties in geological archives like ice sheets, marine and lacustrine sediments, and organic tests (Figure

2.15). The variables measured in archives are calibrated to climatic components, such as air temperature, wind velocity, and precipitation regime. Dating of the geological archive is a crucial step, based on seasonal laminations (e.g., tree rings, growth rings, lacustrine varves) and/or natural radioactive decay of isotopes (e.g., <sup>14</sup>C, <sup>210</sup>Pb). Palaeoclimate reconstructions are then based on the calibration of archive properties (so-called proxies) to the climatic variables of interest, validated by historical data for the last few centuries.

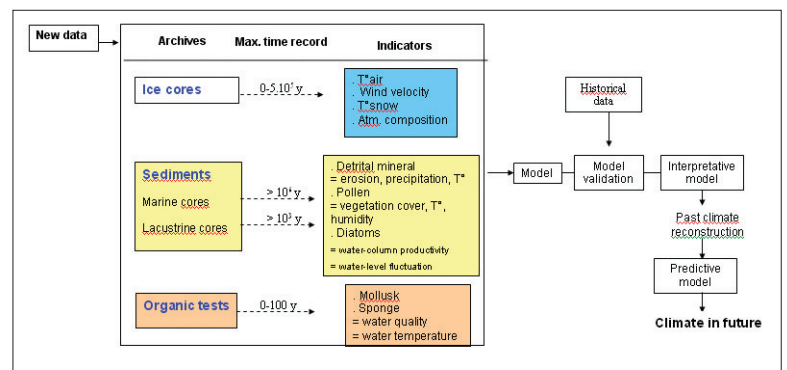

Figure 2.15 - Schematic representation of the approach to the study of the palaeoclimate and its changes using various palaeoclimate archives. (ULg-URAP, UGent-PAE, KMMA / MRAC, UCL-ASTR, UCL-GEOG and FUNDP-URBO).

### 2.2.2 Reconstruction of past climates

Warming in the 20<sup>th</sup> century has a convincing global signature (see Figure 2.4). This is consistent with palaeoclimate evidence that the rate and magnitude of global or hemispheric surface warming in the 20<sup>th</sup> century are likely to have been the greatest in the millennium. Independent estimates of hemispheric and global ground temperature trends over the past five centuries from sub-surface information contained in borehole data confirm the conclusion that late 20<sup>th</sup> century warmth is anomalous in a long-term context (Figure 2.16). Note that because less data are available, less is known about annual averages prior to the

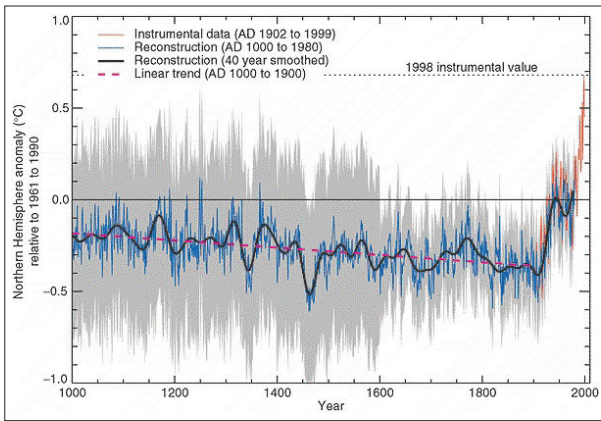

Figure 2.16 - Millennial northern hemisphere (NH) temperature reconstruction (blue) and instrumental data (red) from year 1000 to 1999. Smoother version of NH series (black), linear trend from year 1000 to 1850 (purple-dashed) and two standard error limits (grey shaded) are shown. (IPCC TAR - Climate Change 2001: The Scientific Basis).

last 1,000 years and, for conditions prevailing in most of the southern hemisphere, prior to 1861.

The reconstructions of surface temperature averaged over the northern hemisphere display relatively warm conditions at the beginning of the second millennium, sometimes called the 'Medieval Warm Period'. Although the amplitude and timing of the variations can differ strongly between the different reconstructions, there is general agreement that those warm conditions stopped at the end of the 13<sup>th</sup> century. This was followed by gradual cooling, interrupted by relatively short warm periods. The cold period often referred to as 'the Little Ice Age' ended in the 19<sup>th</sup> century before very pronounced warming in the 20<sup>th</sup> century.

This temperature evolution is well reproduced by a global three-dimensional atmosphere-sea-ice-ocean model driven by natural (solar and volcanic) forcings before

1850 and both natural and anthropogenic (increase in greenhouse gas concentrations and tropospheric aerosols) forcings after 1850 (see Figure 2.17 and Section 2.4 for more details). On the one hand, this shows that these forcings are the main drivers of large-scale temperature evolution over this period. On the other hand, it indicates that present-day models are able to reproduce past climate evolution when driven with adequate forcings.

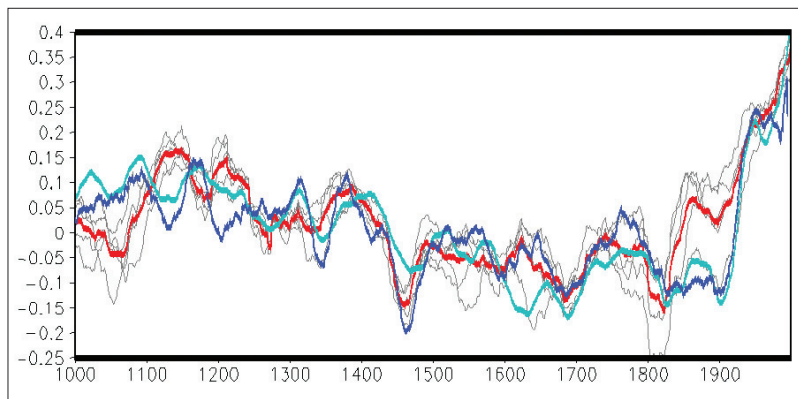

Figure 2.17 – Simulation of climate evolution over the second millennium with a global three-dimensional atmosphere-sea-ice-ocean model using anthropogenic forcings, variations in solar irradiance, and volcano eruptions. A 30-year running mean was applied. Anomaly of annual mean surface temperature averaged over the northern hemisphere in 5 simulations (grey), their mean (red), and temperature reconstructions (dark and light blue). (UCL-ASTR).

### How was the past sea level?

On time scales of 10,000 to 100,000 years, the most important processes affecting sea level are those associated with the growth and decay of the ice sheets through the glacial-interglacial cycles. The fluctuations shown on the composite record in Figure 2.18 demonstrate the occurrence, during a glacial-interglacial cycle, of sea level oscillations exceeding 100 m in magnitude at average rates of up to 10 mm/yr and more during periods of decay of the ice sheets, and sometimes reaching rates as high as 40 mm/yr for periods of very rapid ice sheet decay.

Current best estimates indicate that the total Last Glacial Maximum land-based ice volume exceeded present ice volume by 50 to

53 million km<sup>3</sup>, most of which was stored on the northern hemisphere continents (Figure 2.19).

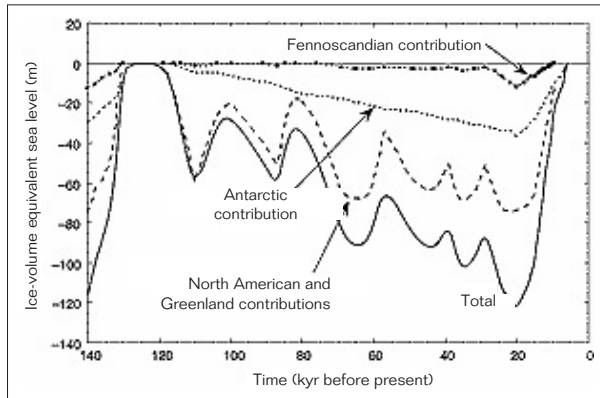

Figure 2.18 - Estimates of global sea level change over the last 140,000 years (continuous line) and contributions to this change from the major ice sheets: (i) North America, including Laurentia, Cordilleran ice, and Greenland, (ii) northern Europe (Fennoscandia), including the Barents region, (iii) Antarctica. (IPCC TAR - Climate Change 2001: The Scientific Basis).

### Were there abrupt decadal changes in the previous warm interglacial period?

A long-term reconstruction of past climate changes has been done from the study of a more than 3,000-m-long ice core drilled in central Greenland: the GRIP core (Greenland Ice Core Project) (Figure 2.20). This study suggests that temperature fluctuations of more than 10°C occurred in Greenland on a scale of less than a century (about 70 years) during the Eemian period. These findings are still the subject of strong debate because there is some evidence of dynamic disturbances of the ice stratigraphy in the deepest part of the core. This emphasises the importance of field studies in describing the physical processes on which modelling has to rely for pertinent prognosis. For example, multiparameter studies performed on the basal

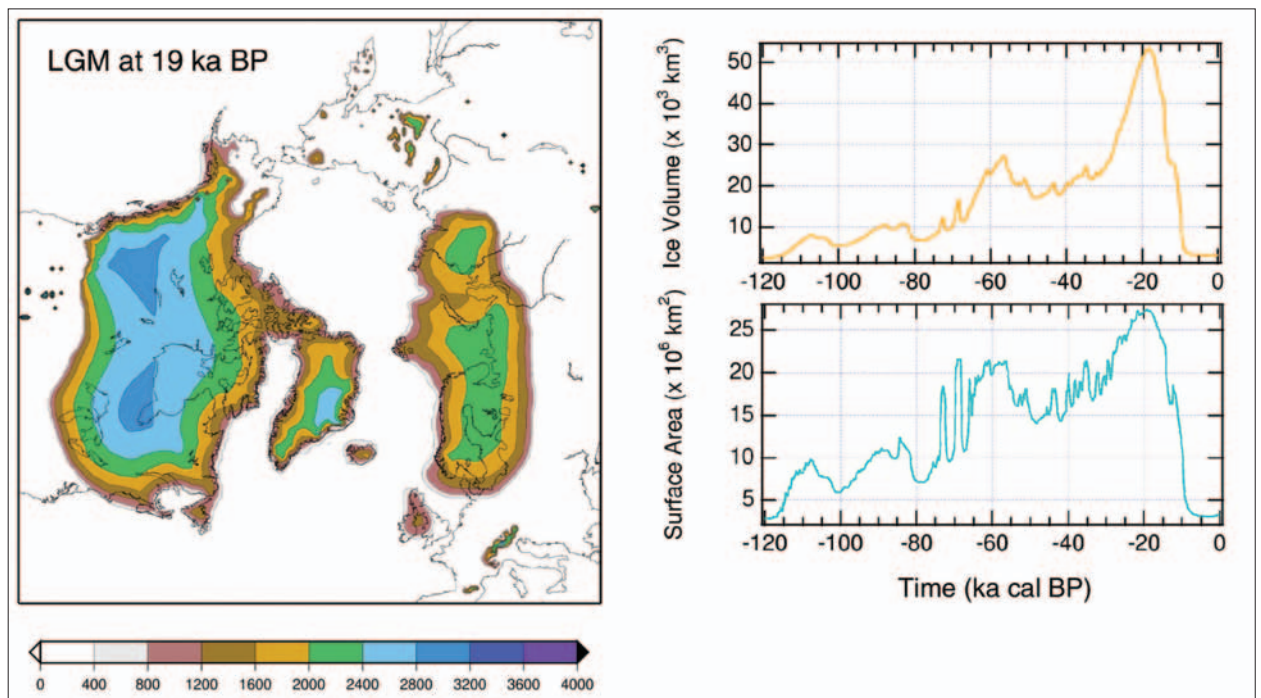

Figure 2.19 - Model simulation over the last glacial cycle showing the evolution of ice volume and surface area and the resulting ice sheet geometry at the Last Glacial Maximum 19 thousand years ago. The major characteristic of the Quaternary ice age was the growth and decay of large ice sheets on the continents of the northern hemisphere. The colour coding in the left panel refers to altitude above sea level. For comparison, an ice volume of 1 million km<sup>3</sup> corresponds to about 2.5 m of global sea level change. (VUB, 2003).

ice of the GRIP core and on the Dye-3 ice core (another deep ice core from the Greenland Ice Sheet Project, GISP) have shown that complex deformation occurred during build-up of the ice sheet, affecting the deep ice layers and thus the associated palaeoclimatic signals.

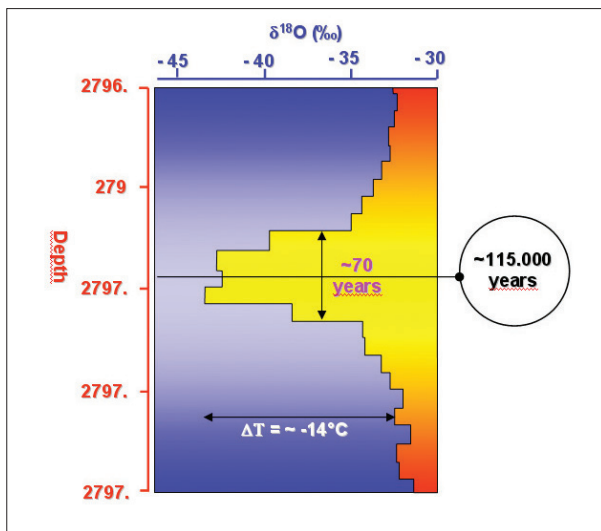

Figure 2.20 - One of the abrupt climatic events recorded in the Eemian section of the GRIP (Greenland Ice Core Project) core. Cooling by about 14°C in less than a century in Greenland was deduced from the  $\delta^{18}\text{O}$  (abundance of the oxygen isotope 18) record by means of a transfer function. It is not yet certain that this major cooling really occurred. (ULB-GLACIOL).

## 2.3 Why has the climate changed in the past?

### 2.3.1 Introduction

The earth absorbs radiation from the sun, mainly at the surface. This energy is then redistributed by the atmospheric and oceanic circulations and radiated back to space at longer (infrared) wavelengths. For the annual mean and for the earth as a whole, the incoming solar radiation energy is balanced approximately by the outgoing terrestrial radiation. Any factor that alters the radiation received from the sun or lost to space or that alters the redistribution of energy within the atmosphere and between

the atmosphere, land, and ocean, can affect climate. A change in the net radiative energy available to the global earth-atmosphere system is here termed a radiative forcing (see Chapter 1). Positive radiative forcings tend to warm and negative radiative forcings tend to cool the earth's surface and lower atmosphere.

- ✓ Increases in the concentrations of greenhouse gases will reduce the efficiency with which the earth's surface radiates to space. More of the outgoing terrestrial radiation from the surface is absorbed by the atmosphere and re-emitted at higher altitudes and lower temperatures. This results in a positive radiative forcing that tends to warm the lower atmosphere and surface. Because less heat escapes to space, the earth's atmosphere will warm, leading to the enhanced greenhouse effect – an enhancement of an effect that has operated in the earth's atmosphere for billions of years because of the presence of naturally occurring greenhouse gases: water vapour, carbon dioxide, ozone, methane, and nitrous oxide.
- ✓ Volcanic activity can inject into the stratosphere large amounts of sulphur-containing gases (primarily sulphur dioxide), which are transformed into sulphate aerosols. Individual eruptions can produce a large, but transitory, negative radiative forcing, tending to cool the earth's surface and lower atmosphere over periods of a few years.
- ✓ The sun's output of energy varies slightly (by about 0.1%) over an 11-year cycle and, in addition, variations over longer periods may occur. On time scales of tens to thousands of years, slow variations in the earth's orbit, which are well understood, have led to changes in the seasonal and latitudinal distribution of solar radiation.

These changes played an important part in controlling climate variations in the distant past, such as the glacial and interglacial cycles.

When radiative forcing changes, the climate system responds on various time scales (Figure 2.21). The longest of these reflect the considerable heat capacity of the deep ocean and dynamic adjustment of the ice sheets. This means that the transient response to a change (either positive or negative) may last for thousands of years. Any changes in the radiative balance of the earth, including those due to an increase in greenhouse gases or in aerosols, will alter the global hydrological cycle and atmospheric and oceanic circulation, thereby affecting weather patterns and regional temperatures and precipitation.

Any human-induced changes in climate will be embedded in a background of natural

climatic variations that occur on a whole range of time and space scales. Climate variability can occur as a result of natural changes in the forcings of the climate system, for example variations in the strength of the incoming solar radiation and changes in the concentrations of aerosols arising from volcanic eruptions. Natural climate variations can also occur in the absence of a change in external forcing, as a result of complex interactions between components of the climate system, such as the coupling between the atmosphere and ocean. The El Niño Southern Oscillation (ENSO) is an example of such natural 'internal' variability on an interannual time scale.

### 2.3.2 External forcings: astronomical factors, solar variability, and volcanic activity

As shown first by Milankovitch, periodic variations of the orbital characteristics of the earth are the pacemaker of climate change on multi-millennial time scales. Atmospheric CO<sub>2</sub> (carbon dioxide) is one of many earth system variables that show the characteristic 'Milankovitch' periodicities. It has been implicated as a key factor in reinforcing natural climate variability at the 100,000-year time scale related to the eccentricity cycle (which affects the shape of the orbit of the earth around the sun, and therefore the total annual amount of solar energy absorbed).

Climate varies naturally on all time scales. Over the last million years or so, glacial and interglacial periods have alternated as a result of variations in the earth's orbital parameters. Based on Antarctic ice cores, more detailed information has become available about the four full glacial cycles of the last 500,000 years. In recent years it was discovered that during the last glacial period, large and very rapid temperature variations took place over large parts of the globe, particularly in the higher latitudes of the northern hemisphere. These

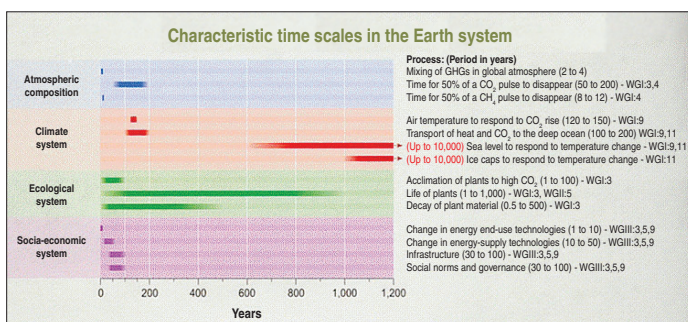

Figure 2.21 - characteristic time scales of some key processes in the earth system: atmospheric composition (blue), climate system (red), ecological system (green), and socio-economic system (purple). 'Time scale' is defined here as the time needed for at least half of the consequences of a change in a driver of the process to be expressed. Problems of adaptation arise when response processes (such as the longevity of some plants) are much slower than driving processes (the change in temperature). Inter-generational equity problems arise for all processes with time scales greater than a human generation, since a large part of the consequences of activities of a given generation will be borne by future generations. (IPCC TAR - Climate Change 2001: The Scientific Basis).

abrupt events involved temperature changes of several degrees within a human lifetime. In contrast, the last 10,000 years appear to have been relatively more stable, though locally quite large changes have occurred.

A simulation made for the next 150,000 years shows that for astronomical reasons, the current interglacial period will probably last very long (50,000 years). Confidence in this result comes from a comparison of the interglacial period 400,000 years ago with the present-day one (Holocene) and from the fact that the relatively high CO<sub>2</sub> concentration will partially compensate the slow insolation decline. If a threshold of ~ 750 ppmv of CO<sub>2</sub> is exceeded over the next 200 years, the Greenland ice sheet will start to melt, disappear within 10,000

years, and start to recover 25,000 years from now, before reaching again its present-day size in 50,000 years time (see Figure 2.22).

### 2.3.3 Internal processes

Regional or local climate is generally much more variable than climate on a hemispheric or global scale, because regional or local variations in one region are compensated for by opposite variations elsewhere. A closer inspection of spatial climate variability, in particular on seasonal and longer time scales, shows that some regional or local variations occur predominantly in preferred large-scale and geographically anchored spatial patterns. These result from interactions between the atmospheric circulation and the land and ocean

surfaces. Though geographically anchored, their amplitude can change in time as, for example, the heat exchange with the underlying ocean changes.

ENSO is one of the most important processes affecting the present-day climate of the earth. It is caused by variations in tradewind intensity and unstable ocean-atmosphere interactions in the tropical Pacific Ocean. It is expressed as an alternation of positive/negative ('El Niño' and 'La Niña') climate anomalies that especially affect the intertropical areas. ENSO occurs cyclically with a pluriannual to decadal period. It has

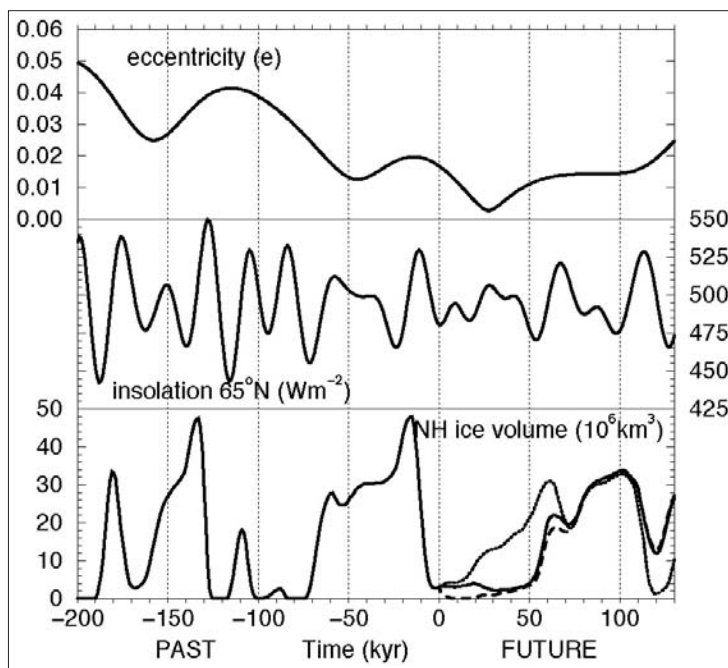

Figure 2.22 - Orbiting the sun. Long-term variations in the earth orbit eccentricity (top), June insolation at 65°N (middle), and simulated northern hemisphere ice volume (bottom) from 200,000 years ago to 130,000 years from now. For the future, three CO<sub>2</sub> scenarios were used: last glacial-interglacial values (solid line), a human-induced concentration of 750 ppmv (dashed line), and a constant concentration of 210 ppmv (dotted line). A decrease in ice volume of 1 million km<sup>3</sup> corresponds with a global sea level increase of about 2.5 m. (UCL-ASTR).

a profound impact on precipitation (droughts, floods) and average seasonal temperature, with effects on fisheries (e.g., Lake Tanganyika, see Figure 2.23), agriculture, the economy, public health, etc. A better understanding of the ENSO phenomenon requires detailed studies in several contrasted areas and settings, because its effects can be highly variable: droughts in Brazil, floods of the Nile, etc. In recent years it

has become clear that ENSO has increased in intensity throughout the 20<sup>th</sup> century and that its impact has become almost global. Recent studies have shown the presence of a pluri-decadal cyclicity (50-70 years) superimposed on ENSO intensity in intertropical areas. Similar pluri-decadal cycles have been identified in the North Atlantic area (the 'North Atlantic Oscillation', NAO) and are attributed to changes in the North Atlantic thermohaline circulation pattern. The NAO consists of opposing variations of barometric pressure near Iceland and near the Azores: on the average, a westerly current between the Icelandic low pressure area and the Azores high pressure area carries cyclones with their associated frontal systems towards Europe. It remains unclear, however, whether a similar ocean-driven cyclicity occurs elsewhere and whether it could represent a global phenomenon.

## 2.4 Why is climate changing now?

### 2.4.1 Are greenhouse gases the real cause of the present climate change?

The earth's climate system has demonstrably changed on both the global and the regional scale since the pre-industrial era, some changes being attributable to human activities. Human activities have increased the atmospheric concentrations of greenhouse gases and aerosols since the pre-industrial era (see Chapter 1.2). The atmospheric concentrations of key anthropogenic greenhouse gases (i.e., carbon dioxide, CO<sub>2</sub>; methane, CH<sub>4</sub>; nitrous oxide, N<sub>2</sub>O; and tropospheric ozone, O<sub>3</sub>) reached their highest recorded levels in the last decade of the 20<sup>th</sup> century, primarily owing to combustion of fossil fuels, agriculture, and land use changes (see Figure 2.24). The radiative forcing from anthropogenic greenhouse gases

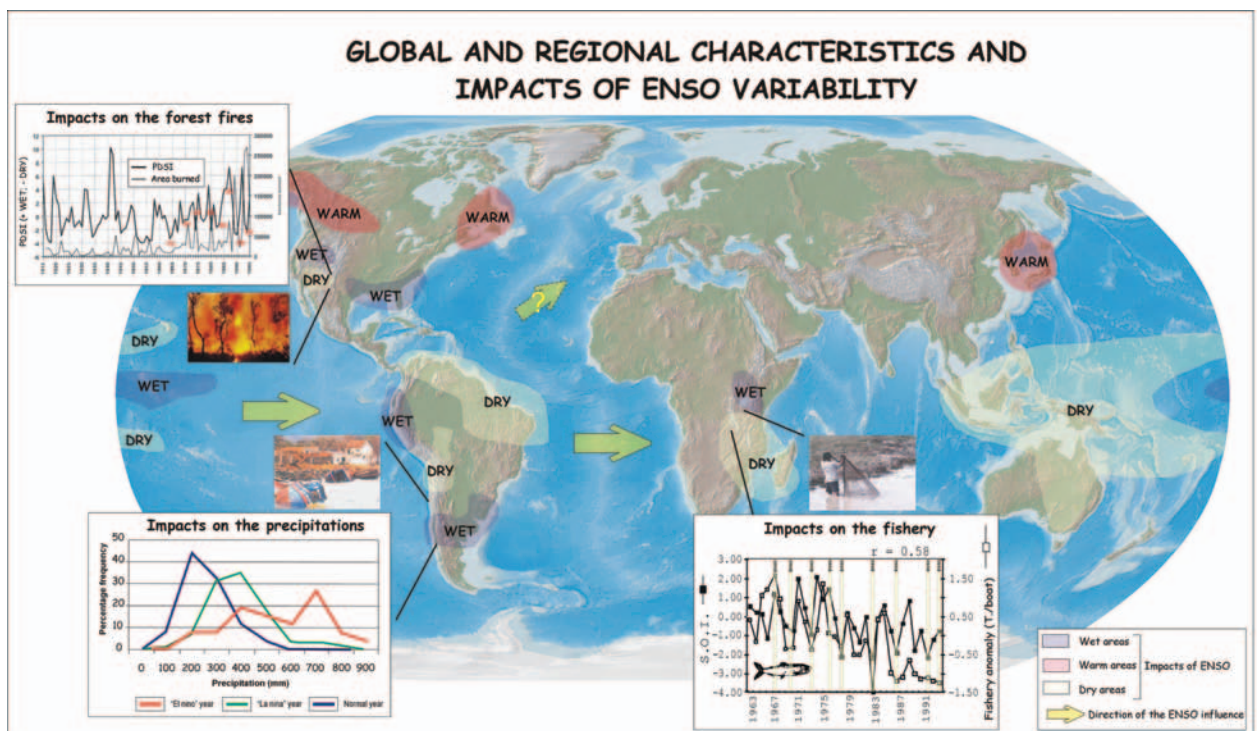

Figure 2.23. – Global and regional characteristics of the 'El Niño Southern Oscillation' (ENSO) and some of its impacts: forest fires in California, precipitation in Chile, and fish catch in Lake Tanganyika, Africa. (ULg-URAP, UGent-RCMG, UGent-PAE, KMMA / MRAC, UCL-ASTR, UCL-GEOG and FUNDP-URBO).



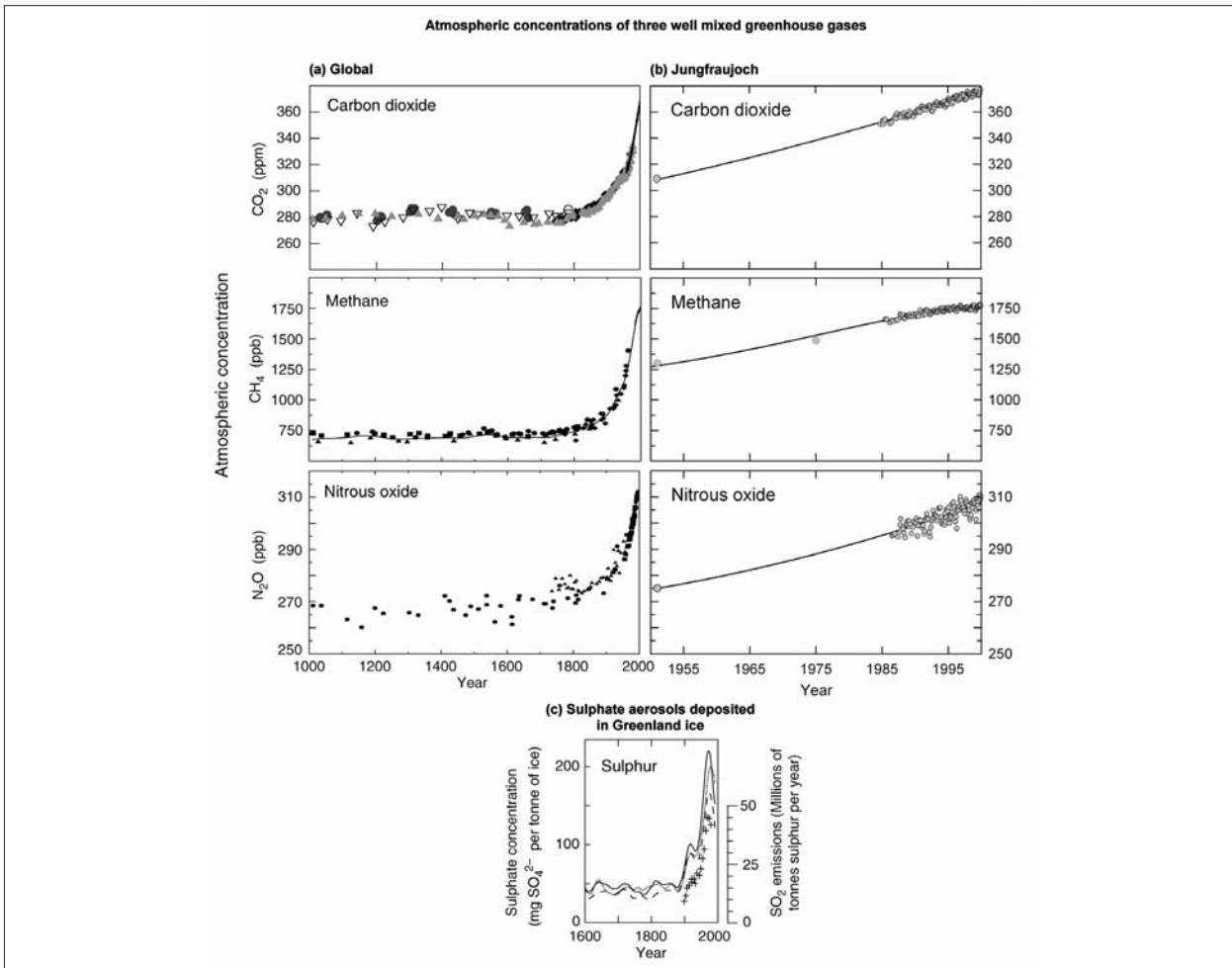

Figure 2.24 – Indicators of the human influence on the atmosphere during the industrial era: atmospheric concentrations of three well-mixed greenhouse gases and sulphate in the Greenland ice. Long records of past changes in atmospheric composition provide the context for the influence of anthropogenic emissions:

a) shows changes in the atmospheric concentrations of carbon dioxide (CO<sub>2</sub>), methane (CH<sub>4</sub>), and nitrous oxide (N<sub>2</sub>O) over the past 1,000 years. The ice core and firn data for several sites in Antarctica and Greenland (shown by different symbols) are supplemented with data from direct atmospheric samples over the past few decades (shown by the line for CO<sub>2</sub> and incorporated in the curve representing the global average of CH<sub>4</sub>). Since these gases have atmospheric lifetimes of a decade or more, they are well mixed, and their concentrations reflect emissions from sources throughout the globe. All three records show effects of the large and increasing growth of anthropogenic emissions in the industrial era.

b) provides details on the more recent temporal evolution of the same species (CO<sub>2</sub>, CH<sub>4</sub>, N<sub>2</sub>O), derived from spectrometric observations at the Jungfraujoch (Switzerland). While CO<sub>2</sub> and N<sub>2</sub>O have continued to increase unabated over the past decades, the rate of CH<sub>4</sub> accumulation has shown a decrease, the cause of which remains unclear. The influence of changes in tropopause height has been taken into account in the data reduction.

c) illustrates the influence of industrial emissions on atmospheric sulphate concentrations, which produce negative radiative forcing. Shown is the time history of the concentrations of sulphate in ice cores from Greenland (shown by lines; from which the episodic effects of volcanic eruptions have been removed). Such data indicate the local deposition of sulphate aerosols at the site, reflecting sulphur dioxide (SO<sub>2</sub>) emissions at mid-latitudes in the northern hemisphere. This record, albeit more regional than that of the globally mixed greenhouse gases, demonstrates the considerable growth in anthropogenic SO<sub>2</sub> emissions over the industrial era. The plus signs denote the relevant regional estimated SO<sub>2</sub> emissions (right-hand scale). (IPCC TAR - Climate Change 2001: The Scientific Basis and ULg-GIRPAS).

is positive, with a small uncertainty range. That from direct aerosol effects is negative and smaller, whereas negative forcing from the indirect effects of aerosols on clouds might be large but is not well quantified.

The IPCC concluded in 2001 that there is new and stronger evidence that most of the warming observed over the last 50 years is attributable to human activities. Detection and attribution studies consistently find evidence for an anthropogenic signal in the climate record of the last 35-50 years. These studies include uncertainties in forcing due to anthropogenic sulphate aerosols and natural factors (volcanoes and solar irradiance), but do not account for the effects of other types of anthropogenic aerosols and land use changes. The sulphate and natural forcings are negative over this period and cannot explain the warming; whereas most of these studies find that, over the last 50 years, the estimated rate and magnitude of warming due to increasing greenhouse gases alone are comparable with, or greater than, the observed warming.

Figures 2.25 and 2.26 show that the best match between three-dimensional model simulations and observations over the last 140 years has been found when all the above anthropogenic and natural forcing factors are combined. Over longer periods, it is useful to use the faster Bidimensional Climate Model (or *Modèle Bidimensionnel Climatique, MoBidiC*), which allows simulations of decadal to millennial climate variability over the last 125,000 years. From 1,000 years ago until the beginning of the industrial era, a significant part of the low-frequency temperature signal could be explained by solar variability expressed in terms of the change in total solar irradiance. Greenhouse gas concentration allows the model to simulate an accelerated warming rate over the last 150 years, in particular in the last three decades. Deforestation, tropospheric

sulphates, changes in insolation, and volcanic activity improve the reproduction of 20<sup>th</sup>-century warming. Anthropogenic forcings (deforestation, greenhouse gases, and sulphates) do not impact climate significantly before the industrial period. Since then, they explain up to 70% of the northern decadal time scale of temperature variations. When all forcings are combined (including solar and volcanic activity), the model captures up to 77% of this variability.

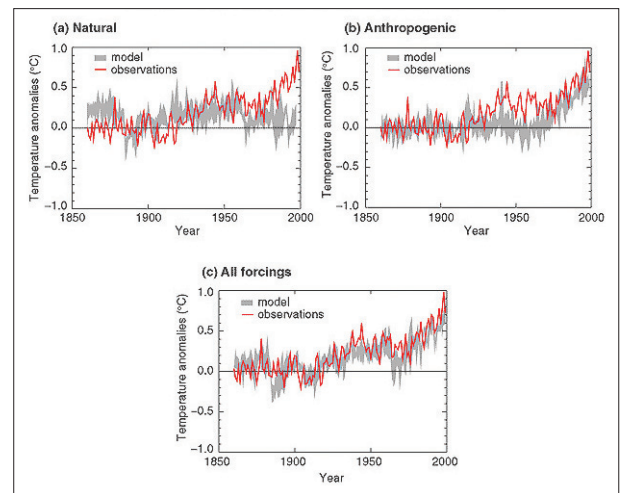

Figure 2.25 – Comparison between modelled and observed temperature rise since 1860. Simulating the earth's temperature variations (°C) and comparing the results with measured changes can provide insight to the underlying causes of major changes. A climate model can be used to simulate temperature changes due to both natural and anthropogenic causes. The simulations represented by the band in (a) were done with only natural forcings: solar variation and volcanic activity. Those encompassed by the band in (b) were done with anthropogenic forcings: greenhouse gases and an estimate of sulphate aerosols. Those encompassed by the band in (c) were done with both natural and anthropogenic forcings included. From (b), it can be seen that inclusion of anthropogenic forcings provides a plausible explanation for a substantial part of the observed temperature changes over the past century, but the best match with observations is obtained in (c), where both natural and anthropogenic factors are included. These results show that the forcings included are sufficient to explain observed changes, but they do not exclude the possibility that other forcings might also have contributed. (IPCC TAR - Climate Change 2001: The Scientific Basis).

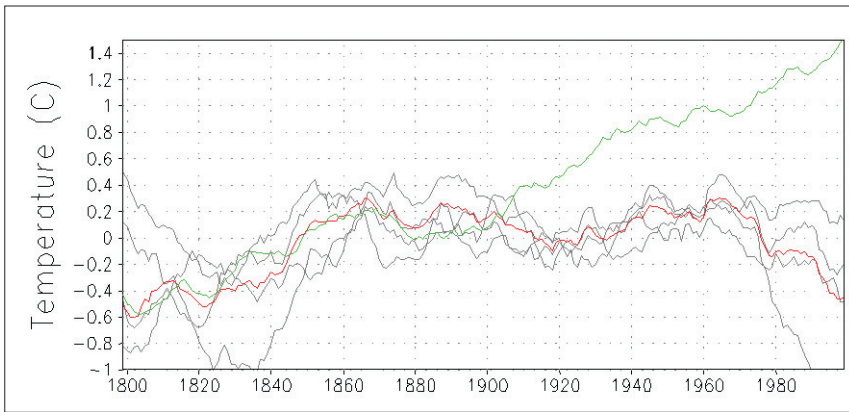

Figure 2.26 - Time evolution of the annual mean surface temperature averaged over the area north of 70°N in an ensemble of 5 simulations (grey) performed with an atmosphere-ocean-sea-ice model driven by natural forcings only. The mean value over the period 1000-1750 has been subtracted from the time series. The red line is the mean of the 5 simulations. Using these forcings only, no simulation is able to reproduce the major warming observed over the 20<sup>th</sup> century in these regions (Figure 2.23). To do so, it is necessary to include anthropogenic forcings in the simulations (green line). A 30-year running mean has been applied to each time series. (UCL-ASTR).

### 2.4.2 Can we explain the 20<sup>th</sup> century sea level rise?

The average estimated rate of sea level rise over the 20<sup>th</sup> century is between 1.0 and 2.0 mm/yr, with a central value of 1.5 mm/yr. In order to have confidence in our ability to predict future changes in sea level, we need to confirm that we can explain this current rate of change. According to the IPCC TAR - Climate Change 2001: The Scientific Basis (2001), the contributions of all components of sea level rise in the 20<sup>th</sup> century can be estimated to range from -0.8 mm to 2.2 mm/yr, with a central value of 0.7 mm/yr (Figure 2.27). In this assessment, the greatest uncertainty (by a factor of more than two) is in the terrestrial storage terms, especially from the effect of dam building. In contrast to earlier assessments, the contribution of continental ice masses and its uncertainty range are smaller,

but still considerable.

Sea level varies as a result of processes operating on different time scales. Thermal expansion of the oceans as well as the global ocean thermohaline circulation has a memory of centuries. Ice sheets react to climate change on the time scale of millennia,

and could be gaining or losing mass as a result of climatic variations extending back to the last glacial period (which ended 11,000-12,000 years ago). Glaciers and ice caps are more sensitive to climate change and are able to adjust more rapidly to changes in snow accumulation and ice melting. They may dominate the response on a century time scale.

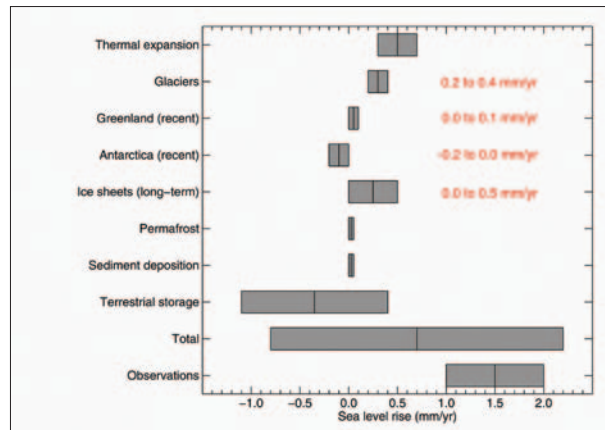

Figure 2.27 - Ranges of uncertainty for the average rate of sea level rise in the 20<sup>th</sup> century, and estimated contributions of different processes. (IPCC TAR - Climate Change 2001: The Scientific Basis).

#### Contribution of thermal expansion

The contribution of thermal expansion derived from observational estimates is about 1 mm/yr over recent decades. Circulation model simulations averaged over the whole 20<sup>th</sup> century, however, give a thermal expansion of 0.3 to 0.7 mm/yr.

### Ice-sheet contribution

Ice sheets continuously exchange fresh water with the ocean. They gain mass by accumulation of snow. The average annual solid precipitation falling onto the Antarctic and Greenland ice sheets is equivalent to 6.5 mm of sea level. This input is approximately balanced by loss from melting and iceberg calving due to slow downhill ice movement under the action of gravity. For the two polar ice sheets, the balance of these processes is not the same. This is due to their different climatic regimes. If mass balance is not in equilibrium, the sea level will change and the mass and shape of the ice sheets will adjust until a steady state is regained. This occurs on time scales in the order of a hundred to ten thousand years. Despite recent

advances in understanding polar ice sheets, their current mass balance is not yet known.

Ice-ocean interactions below ice shelves fringing the Antarctic ice sheet give rise to another set of processes that may influence sea level but whose impact is poorly known. As shown in Figure 2.28, which illustrates the potential complexity of climate processes, annual sea ice build-up around Antarctica is responsible for ice shelf melting at the grounding line and marine ice production below the ice shelf. This new ice produced at the base accumulates in wide crevasses and at the grounding line, between individual ice streams where they meet to form the ice shelf. It is also found in frontal crevasses, between icebergs soon to be calved. It therefore acts as a 'welding' agent, stabilising

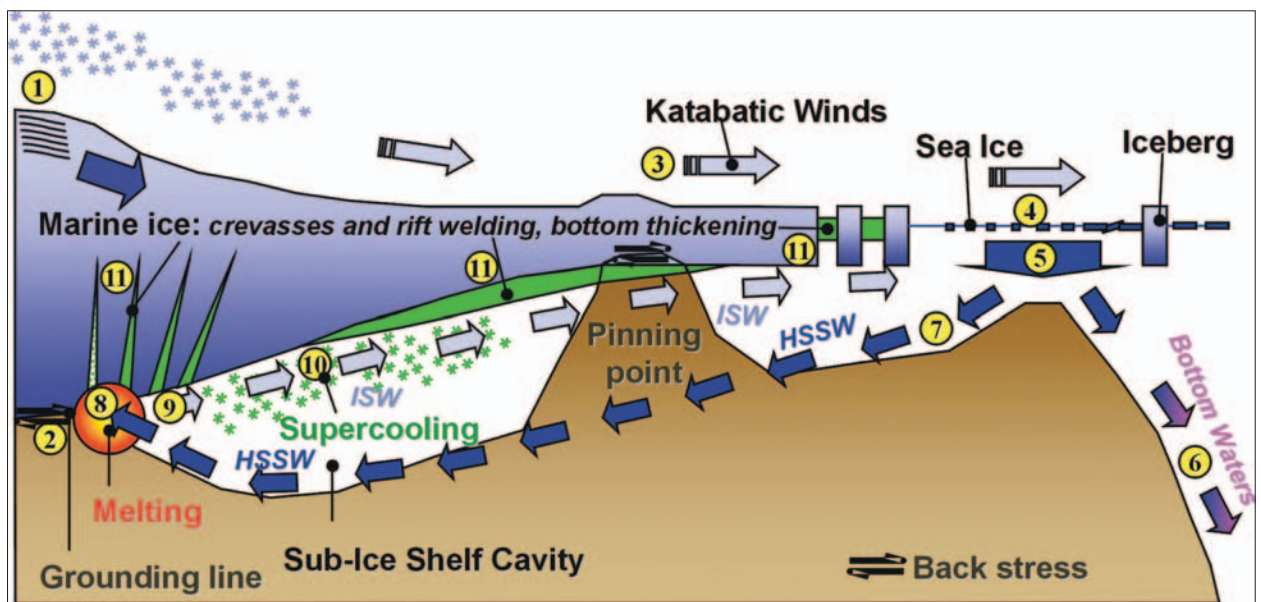

Figure 2.28 - Atmosphere – ice – ocean interactions around Antarctica. Continental meteoric ice forms from the metamorphism of snow piling up at the surface of the ice sheet (1). The ice flows towards the border of the continent under its own weight. It starts to get afloat under Archimedes's law, as it thins down and meets the ocean at the grounding line (2). Katabatic winds blow from the high-atmospheric-pressure area (cold air) on the ice sheet plateau towards the low-pressure area on the ocean (3). This sustains the freezing of very large amounts of ice (sea ice) at the ocean surface (4). Sea ice expels salts from its structure, this resulting in the production of denser cold and salty waters (High Salinity Shelf Water, HSSW) that sink towards the bottom of the ocean (5). Most of this water forms the Bottom Waters (6), a major component of the global thermohaline circulation. Part of it, however, flows back into the sub-ice shelf cavity (7) where it melts continental ice at the grounding line (8). It forms lighter Ice Shelf Water (ISW) (9) that ascends along the ice shelf base. The balance between grounding line melting and marine ice accretion is still poorly known and likely to strongly impact ice shelf and ice sheet stability against a warming climate. (ULB-GLACIOL).

the ice shelf flow and hampering iceberg release. The impact of such processes of grounding line melting and marine ice accretion is still a major unknown.

An independent way to obtain an estimate of the present ice evolution is to model the past history of ice sheets and their underlying beds over a glacial cycle. These ice sheet simulations suggest that the Greenland ice sheet is close to balance, while the Antarctic ice sheet is still losing mass, mainly because of incomplete grounding line retreat of the West Antarctic Ice Sheet (WAIS) since the Last Glacial Maximum (Figure 2.29). The long-term ice dynamic response is estimated to be between  $-0.1$  and  $0.0$  mm/yr of sea level equivalent from the Greenland ice sheet and between  $+0.1$  and  $0.5$  mm/yr from the Antarctic ice sheet. Model simulations suggest that anthropogenic climate change may have produced an additional contribution of between  $-0.2$  and  $0.0$  mm/yr of sea level from increased snow accumulation in Antarctica over the last 100 years, and a contribution amounting to between  $0.0$  and  $0.1$

mm/yr from Greenland, from both increased snow accumulation and mass losses (melting, iceberg, etc.).

In the future, thermal expansion of seawater and melting of glaciers and ice caps are likely to raise the average sea level by 1 to 9 mm/yr (see Section 2.5).

### 2.5 How will climate likely change during the 21<sup>st</sup> century?

#### 2.5.1 Global level

**Human influences will continue to change atmospheric composition throughout the 21<sup>st</sup> century**

The emissions scenarios used as references to project future climates are from the IPCC's Special Report on Emissions Scenarios (IPCC SRES, 2000). (Box 2.1). An illustrative scenario was chosen for each of the six scenario groups A1B, A1FI, A1T, A2, B1 and B2. All should be considered equally sound. The SRES scenarios do not include additional climate initiatives, which means that no scenarios are

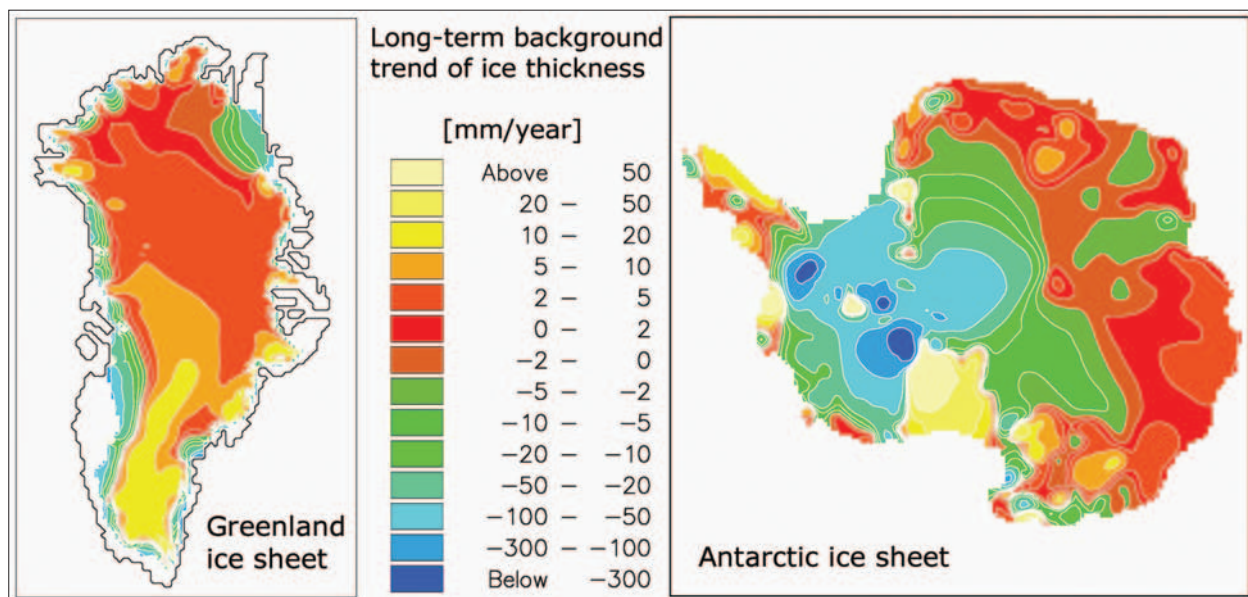

Figure 2.29 - The current mass balance of the Antarctic and Greenland ice sheets as diagnosed from the modelled ice sheet response after two glacial cycles. Shown are ice thickness evolution patterns obtained from comprehensive 3-D ice sheet/lithosphere models. Long-term background values are averages over the last 200 years. (VUB-DG, 1999).

included that explicitly assume implementation of the United Nations Framework Convention

on Climate Change (UNFCCC) or the emissions targets of the Kyoto Protocol.

### Box 2.1 - Emissions Scenarios of the IPCC Special Report on Emissions Scenarios (IPCC SRES, 2000)

- A1.** The A1 storyline and scenario family describes a future world of very rapid economic growth, global population that peaks in mid-century and declines thereafter, and the rapid introduction of new and more efficient technologies. Major underlying themes are convergence among regions, capacity building and increased cultural and social interactions, with a substantial reduction in regional differences in per capita income. The A1 scenario family develops into three groups that describe alternative directions of technological change in the energy system. The three A1 groups are distinguished by their technological emphasis: fossil intensive (A1FI), non-fossil energy sources (A1T), or a balance across all sources (A1B) (where balanced is defined as not relying too heavily on one particular energy source, on the assumption that similar improvement rates apply to all energy supply and end use technologies).
- A2.** The A2 storyline and scenario family describes a very heterogeneous world. The underlying theme is self-reliance and preservation of local identities. Fertility patterns across regions converge very slowly, which results in a continuously increasing population. Economic development is primarily regionally oriented and per capita economic growth and technological change more fragmented and slower than other storylines.
- B1.** The B1 storyline and scenario family describes a convergent world with the same global population, that peaks in mid-century and declines thereafter, as in the A1 storyline, but with rapid change in economic structures toward a service and information economy, with reductions in material intensity and the introduction of clean and resource-efficient technologies. The emphasis is on global solutions to economic, social and environmental sustainability, including improved equity, but without additional climate initiatives.
- B2.** The B2 storyline and scenario family describes a world in which the emphasis is on local solutions to economic, social and environmental sustainability. It is a world with a continuously increasing global population, at a rate lower than in A2, intermediate levels of economic development, and less rapid and more diverse technological change than in the B1 and A1 storylines. While the scenario is also oriented towards environmental protection and social equity, it focuses on local and regional levels.

On the basis of these SRES scenarios, models have been used to make projections of atmospheric concentrations of greenhouse gases and aerosols, and hence of future climate (Figure 2.30). The main results are as follows:

- ✓ Emissions of CO<sub>2</sub> due to fossil fuel combustion are virtually certain to be the dominant influence on trends in atmospheric CO<sub>2</sub> concentration in the 21<sup>st</sup> century.
- ✓ By 2100, carbon cycle models project atmospheric CO<sub>2</sub> concentrations of 490 to 1,260 ppm for the illustrative scenarios (75 to 350% above the concentration of 280

ppm in the year 1750) (Figure 2.30b).

- ✓ Changing land use could influence atmospheric CO<sub>2</sub> concentration. Hypothetically, if all of the carbon released by historical land use changes could be restored to the terrestrial biosphere in the course of the century (e.g., by reforestation), CO<sub>2</sub> concentration would be reduced by 40 to 70 ppm.

**Global average variables such as temperature and sea level are projected to rise under all IPCC scenarios**

In order to make projections of future climate, models incorporate past as well as future emissions of greenhouse gases and aerosols. Hence, they include estimates of warming to date and the commitment to future warming from past emissions.

**Temperature**

- ✓ The globally averaged surface temperature is projected to increase by

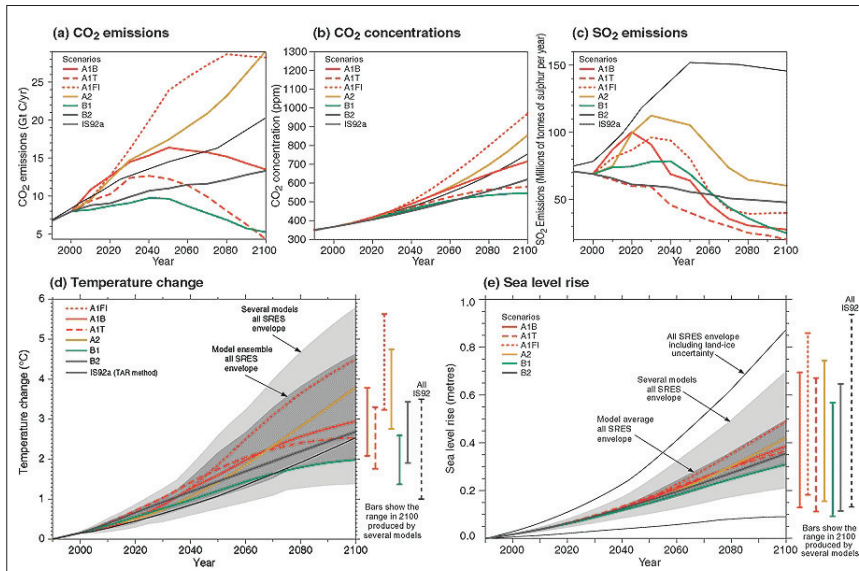

Figure 2.30 - The global climate of the 21<sup>st</sup> century. The global climate will depend on natural changes and the response of the climate system to human activities. Climate models project the response of many climate variables – such as increases in global surface temperature and sea level – to various scenarios of greenhouse gas and other human-related emissions. (a) shows the CO<sub>2</sub> emissions of six illustrative scenarios. (b) shows projected CO<sub>2</sub> concentrations. (c) shows anthropogenic SO<sub>2</sub> emissions. Emissions of other gases and other aerosols were included in the model but are not shown in the figure. (d) and (e) show the projected temperature and sea level responses, respectively. Note that the warming and sea level rise from these emissions would continue well beyond 2100. (IPCC TAR - Climate Change 2001: The Scientific Basis).

1.4 to 5.8°C (Figure 2.30d) over the period 1990 to 2100.

- ✓ The projected rate of warming is much greater than the changes observed over the 20<sup>th</sup> century and will be unprecedented over at least the last 10,000 years.
- ✓ On time scales of a few decades, the current observed rate of warming can be used to constrain the projected response to a given emissions scenario despite uncertainty in climate sensitivity. This approach suggests that anthropogenic warming will probably lie in the range of 0.1 to 0.2°C per decade over the next few decades (Figure 2.30d).

- ✓ Many models project a continuation of recent trends for surface temperature to become more El Niño-like in the tropical Pacific, with the eastern tropical Pacific warming more than the western tropical Pacific and a corresponding eastward shift of precipitation.

### **Precipitation**

- ✓ On the basis of global model simulations and for a wide range of scenarios, global average water vapour concentration and precipitation are projected to increase during the 21<sup>st</sup> century. By the second half of the 21<sup>st</sup> century, precipitation will probably have increased over northern mid-to high latitudes and Antarctica in winter. At low latitudes, there are both regional increases and regional decreases over land areas. There will be greater year-to-year variations in precipitation over most areas where an increase in mean precipitation is projected.

### **Extreme Events**

- ✓ Models project that increasing atmospheric concentrations of greenhouse gases will result in changes in the frequency, intensity, and duration of extreme events, such as more hot days, heat waves, and heavy precipitation events and fewer cold days in temperate regions. Many of these projected changes would lead to increased risks of floods and droughts in many regions, and to predominantly adverse impacts on ecological systems, socio-economic sectors, and human health. High-resolution modelling studies suggest that the peak wind and precipitation intensities of tropical cyclones are likely to increase over some areas.

- ✓ Overall, climate change is projected to increase threats to human health, particularly in lower-income populations, predominantly within tropical/subtropical countries. Climate change can affect human health directly (e.g., reduced cold stress in temperate countries, but increased heat stress, loss of life in floods and storms) and indirectly through changes in the ranges of disease vectors (e.g., mosquitoes), water-borne pathogens, water quality, air quality, and food availability and quality. The actual health impacts will be strongly influenced by local environmental conditions and socio-economic circumstances, and by the range of social, institutional, technological, and behavioural adaptations made to reduce the full range of threats to health.

### **Thermohaline circulation**

- ✓ Most models show weakening of the deep-ocean large-scale density-driven (thermohaline) circulation, leading to a reduction of heat transport into high latitudes of the northern hemisphere. Yet even in models where the thermohaline circulation weakens, there is still a warming over Europe due to increased greenhouse gases. Beyond 2100, this ocean circulation could completely, and possibly irreversibly, shut down in either hemisphere if the change in radiative forcing is large enough and applied long enough.

### **Snow and ice**

- ✓ Northern hemisphere snow cover and sea ice extent are projected to decrease further.
- ✓ Glaciers and ice caps are projected to continue their widespread retreat during the 21<sup>st</sup> century (see Figure 2.31).



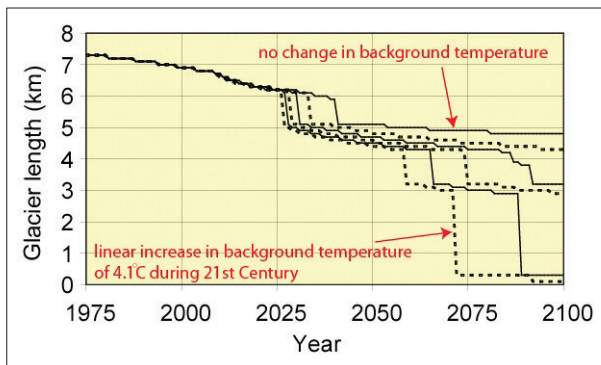

Figure 2.31 - Future scenarios for the Sofiyskiy Glacier, a major glacier in the Altai Mountains, South Siberia (Russia). Glacier response was projected with a numerical glacier model for 6 mass balance scenarios starting at 2000. Scenarios are given for linear summer temperature increases of 0, 0.82, 1.46, 2.46, 3.28, and 4.10°C over the 21<sup>st</sup> century. The upper curve gives the 'no change' scenario. The bottom curve corresponds to the largest summer temperature increase. In the latter case, the glacier will completely disappear by 2100. (VUB-DG).

- ✓ The Antarctic ice sheet will probably gain mass during the 21<sup>st</sup> century because of greater precipitation, while the Greenland ice sheet will probably lose mass because the increase in runoff will exceed the precipitation increase. If the warming continues beyond 2100, both ice sheets are expected to contribute approximately 60 cm/century to the global sea level.

### Sea level

- ✓ Global mean sea level is projected to rise by 0.09 to 0.88 m between the years 1990 and 2100, for the full range of IPCC scenarios, but with significant regional variations. This rise is due primarily to thermal expansion of the oceans and melting of glaciers and ice caps.
- ✓ In the long term, thermal expansion would continue to raise sea level for many centuries after stabilisation of greenhouse gas concentrations. Melting of all existing glaciers and ice caps would raise sea level

by 0.5m. Together, the Greenland and Antarctic ice sheets are found today to contribute slightly negatively to sea level rise because of increased accumulation of snow over Antarctica (Figure 2.32), but they could contribute approximately to a 6 m sea level rise over the next 1,000 years.

- ✓ The geographical pattern of regional sea level change may, however, show major variation, depending on the regional temperature change and on changes in the ocean circulation. Further, land movements (e.g., tectonic ones) will continue through the 21<sup>st</sup> century at rates unaffected by climatic change. Extreme high water levels will occur with increasing frequency as a result of mean sea level rise. Secondly, the height of storm surges may be further increased if storms become more frequent or severe as a result of stronger winds of lower pressures. The available model studies for the North Atlantic and North Sea, however, do not identify any significant change in extreme events other than those associated with the rise of the mean.

### Modelling at the global level

Numerical experiments have been conducted with a coupled general circulation model (CGCM) in order to investigate the evolution of climate in the 21<sup>st</sup> century in response to human activities. The model consists of an atmospheric component and an ocean and sea ice component.

A reference simulation of 150-year duration was first performed with the CGCM. In this run, atmospheric greenhouse gas and sulphate-aerosol amounts were held fixed at the 1970 values. The model was then run from the beginning of year 21 of this experiment for 130 years (corresponding to the period 1971–2100) with greenhouse gas and sulphate-aerosol concentrations increasing in time according to

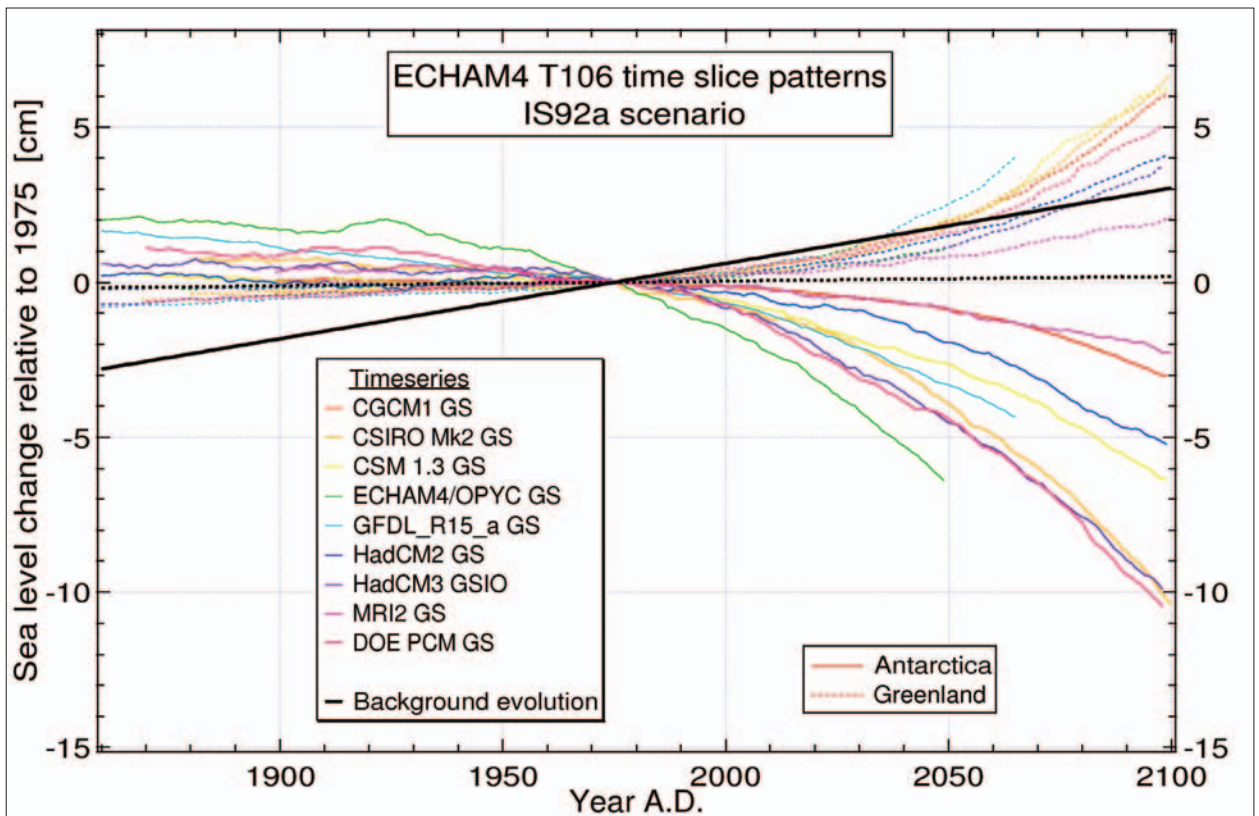

Figure 2.32 - Projected mass changes over the Antarctic and Greenland ice sheets obtained from 3-D ice sheet models. The background evolution resulting from the ongoing response to past climate changes is shown by the thick black lines. These simulations formed the basis of the sea level projections of the IPCC TAR - Climate Change 2001: The Scientific Basis. (VUB-DG).

the IPCC SRES B2 scenario (see Box 2.1).

By the end of the 21<sup>st</sup> century, the model simulates a global surface warming of 2.5°C and an increase in average precipitation of 3.5%. These values fall within the range of estimates obtained with other climate models (e.g., IPCC TAR - Climate Change 2001: The Scientific Basis). The global mean rate of temperature change is projected to be 0.2°C per decade, i.e., twice the rate of change that many of the more sensitive ecosystems are thought to be capable of surviving. Figure 2.33a shows the projected regional warming patterns for the end

of the 21<sup>st</sup> century. Note that it warms nearly everywhere. Western Europe experiences a mean warming ranging between 3 and 6°C (annually-averaged temperature) from 1970 to 2100. According to the simulation, increased

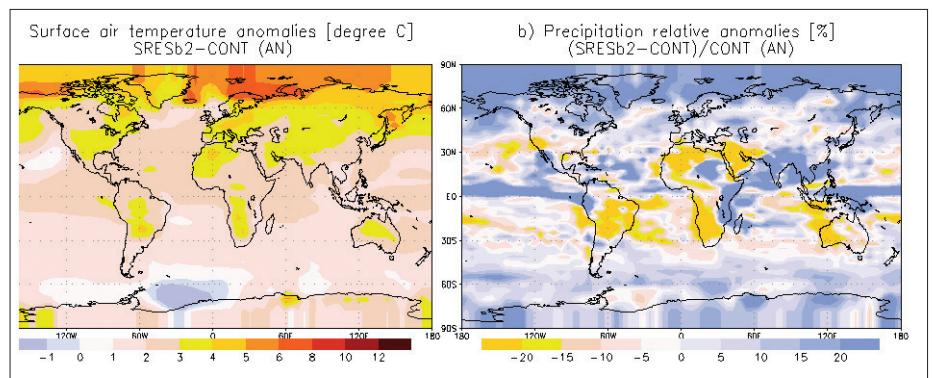

Figure 2.33 - Changes in annual mean surface air temperature (in °C; a) and precipitation (in %; b) between 1970 and 2100 as simulated by a coupled general circulation model. (UCL-ASTR).

precipitation is expected in 2100 in mid- and high-latitude regions, especially in winter, and in parts of the Intertropical Convergence Zone (Figure 2.33b). Decreases in precipitation are likely in many parts of the subtropics. The projected rise in sea level due to thermal expansion reaches 21 cm at the end of the experiment (i.e. 2100).

## 2.5.2 Regional level

### *Importance of the regionalisation of climate change and its impacts*

The increasing request by the scientific community, policymakers, and the public for realistic projections of possible regional impacts of future climate changes has rendered the issue of regional climate simulation critically important. The problem of projecting regional climate changes can be identified as that of representing effects of atmospheric forcings on two different spatial scales: large-scale forcings (for example, greenhouse gas abundance) and mesoscale forcings (for example, complex mountainous systems). The former modify the general circulation and determine the sequence of weather events characterising the climate regime of a region, while the latter modify the local circulation and regulate the regional distribution of climatic variables.

General circulation models (GCMs) are the main tools available today for climate simulation over the whole earth. Yet they are run and will likely be run for the next several years at resolutions too coarse (typically 300 km horizontal resolution) to adequately describe mesoscale forcings and yield accurate regional climate detail.

Modelling with regional climate models (RCMs) offers an alternative and complementary approach over any area of interest. These models are characterised by their increased resolution (typically 10-50 km horizontal resolution) and are usually nested (embedded) in a lower-resolution global model (GCM).

### *Substantial differences are projected in regional changes in climate and sea level, compared to the global mean change*

- ✓ It is very likely that nearly all land areas will warm more rapidly than the global average, particularly those at northern high latitudes in winter.
- ✓ Precipitation will increase over high-latitude regions in both summer and winter.
- ✓ The projected range of regional variation in sea level change is substantial compared to projected global average sea level rise.

Summer runoff, water availability, and soil moisture will likely decrease in southern Europe and the gap between North and South will widen. Flood hazards will increase across much of Europe: the risk should be substantial for coastal areas, where flooding will increase erosion and result in loss of wetlands. Half of the alpine glaciers and large permafrost areas could disappear by the end of the 21<sup>st</sup> century.

## 2.5.3 Hydrological level

Three different hydrological models have been tested, calibrated, and validated on three Belgian test basins (the Gette/Gete, Geer/Jeker, and Ourthe basins). They demonstrate their ability to take into account the major hydrological processes that occur in the soil, groundwater, and surface water compartments and to simulate the behaviour of the terrestrial hydrological cycle under the present climate conditions.

Climate change scenarios, with changes in meteorological variables, have been elaborated on the basis of the results of three of the seven general circulation models (GCMs) used by the IPCC. These three models offer the highest resolution possible (in time and space) for GCMs and the most contrasted changes. Forced by the IPCC IS92a emission scenario

without aerosols (pretty much a 'business-as-usual' scenario), they provide projected monthly values of temperature and precipitation changes over the 21<sup>st</sup> century. Belgian local climate change values are constructed by combining the appropriate monthly change rates with the daily values of a baseline period (1961-1990), corresponding to the 30-year simulation period of the GCMs. Projected temperature and precipitation changes for the 21<sup>st</sup> century are presented in Figure 2.34 for three time periods: 2010-2039, 2040-2069 and 2070-2099.

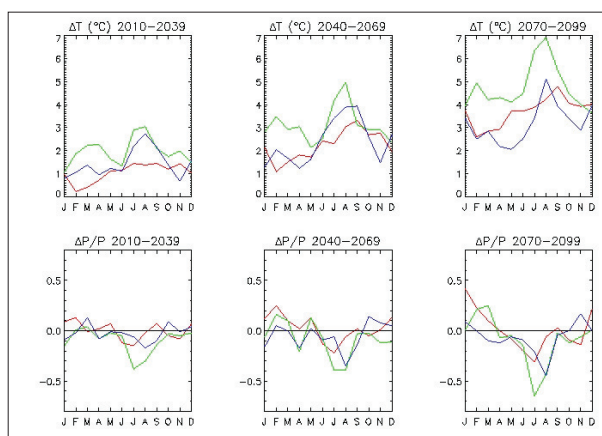

Figure 2.34 - Calculated changes (compared to 1961-1990) in temperature and precipitation in Belgium from three coupled general circulation models (blue: HADCM2 (UK Hadley Centre for Climate Prediction and Research), green: ECHAM4 (German Climate Research Centre), red: CGCM1 (Canadian Centre for Climate Modelling and Analysis)) forced with the same IPCC emission scenario (IS92a without aerosols) for three time periods. (ULg-CEME, ULg-LIGH, FUSAGx-UHAGx, KULeuven-H&EG, IRM / KMI).

These results obtained with the hydrological models clearly demonstrate that the projected climate changes may have significant impacts on the hydrological cycle of these basins at the horizon of the mid-21<sup>st</sup> century (Figure 2.35).

For almost all of the climate simulations shown, the results over the Belgian test basins show:

- ✓ a decrease in soil moisture rates during summertime,

- ✓ a decrease in groundwater piezometric levels, and
- ✓ a decrease in low river flow rates.

For one of these simulations, the results show an increase in mean monthly river flows during winter (January, February, March), while two simulations show a decrease in mean monthly winter river flows. A more precise assessment of the effects of potential climate changes on high flows (floods) will be possible in the future, when new and more detailed GCM results become available.

## 2.6 Are unexpected climate events possible in the longer term?

### 2.6.1 Introduction

Greenhouse gas forcing in the 21<sup>st</sup> century could set in motion large-scale, high-impact, non-linear, and potentially abrupt changes in physical and biological systems over the coming decades to millennia, with a wide range of associated likelihoods.

- ✓ Some of the projected abrupt and non-linear changes in physical systems and the natural sources and sinks of greenhouse gases could be irreversible, but there is an incomplete understanding of some of the underlying processes. Examples of such changes are the possible, and maybe irreversible, shutdown of the ocean thermohaline circulation and sea level rise through melting of the Greenland ice sheet or the West Antarctic ice sheet.
- ✓ Changes in climate could increase the risk of abrupt and non-linear changes in many ecosystems, which would affect their function, biodiversity, and productivity. Examples are the abrupt breakdown of terrestrial and marine ecosystems (with an increased risk of extinction), increased water temperatures leading to coral bleaching, and the disruption

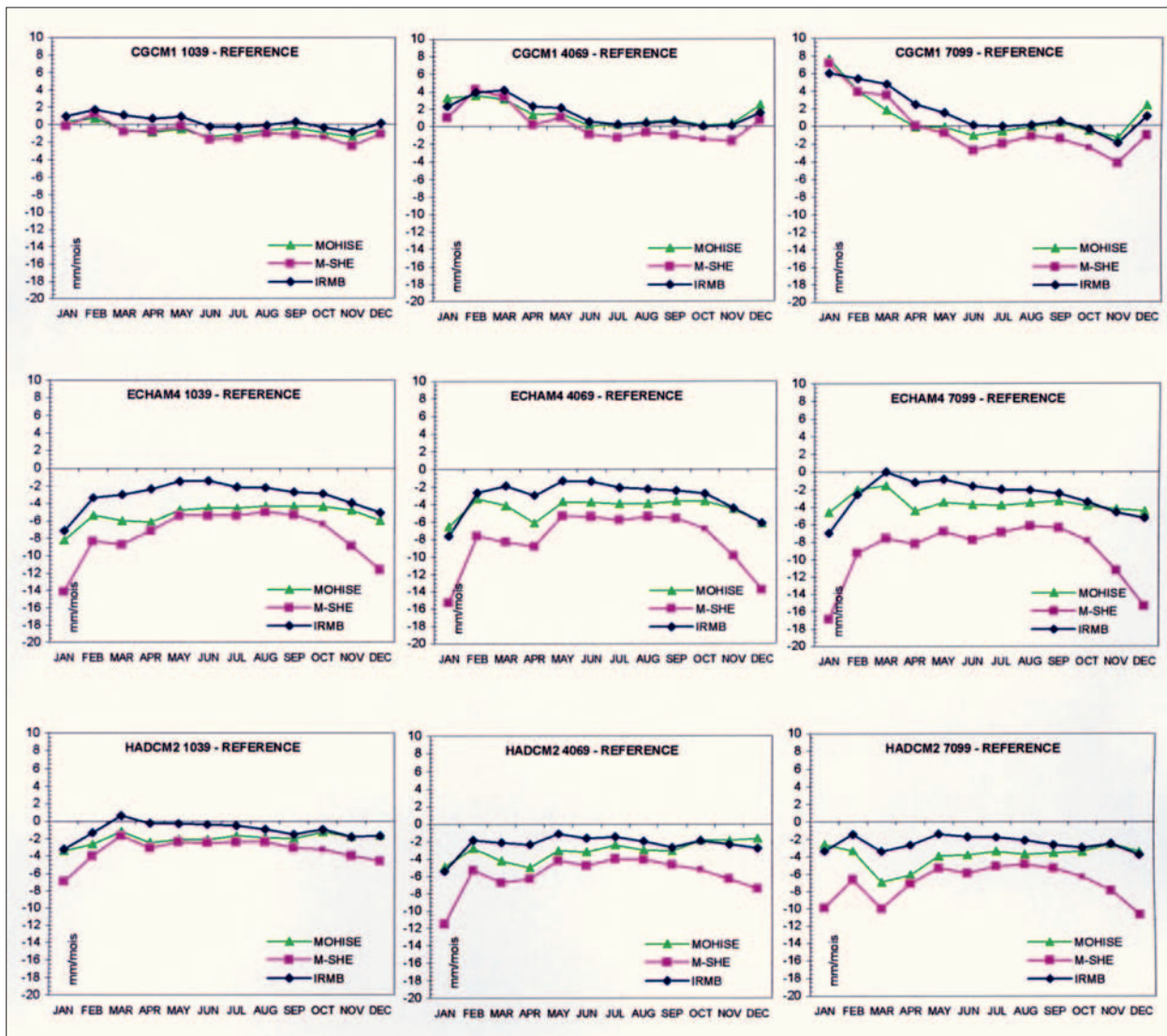

Figure 2.35 - Expected mean monthly changes in total discharge (mm/month) in the Gette/Gete Basin, calculated by three hydrological models forced with projections from three climate models (see caption of Figure 2.34) forced with the same IPCC emission scenario (IS92a without aerosols) (from top to bottom) for the years 2010-2039, 2040-2069 and 2070-2099 respectively (from left to right). (ULg-CEME, ULg-LIGH, FUSAGx-UHAGx, KULeuven-H&EG, IRM / KMI).

of development stages of some crops due to increased temperature, leading to crop yield losses.

## 2.6.2 Abrupt changes

Although the last 11,000 years has long been regarded as climatically unusually stable, recent data have shown that it is characterised by several abrupt cooling periods, which are especially well documented in the North Atlantic region but which probably affect climate on a

global scale. The most recent and probably the most pronounced of these cooling periods was the 'Little Ice Age' (LIA), which occurred between 1300 and 1850 and was observed on a global scale. LIA-like cold periods appear to have occurred more or less regularly with an interval of about 2,500 years, and they are attributed to interactions between the North Atlantic oceanic circulation, the Greenland ice sheet, and polar atmospheric circulation. Possibly, they might also be controlled by solar activity

and thus be of global importance, although they have not yet been clearly documented in the southern hemisphere (except for the LIA itself). Instead, recent work in tropical South America has suggested that climate evolution over the last 11,000 years was distinctly different from that in the northern hemisphere, and that the present-day ENSO system did not appear until about 5,000 years ago. Moreover, historical climate records from South America seem to show a change in the ENSO climate pattern and intensity during the LIA, but the exact effects and mechanisms remain unclear. In East Africa, the LIA was characterised by periods of extreme drought.

### Stability of the Antarctic ice sheet

Scientists give special attention to the

West Antarctic Ice Sheet (WAIS), because it contains enough ice to raise sea level by 6 m and because of suggestions that instabilities associated with it, being grounded below sea level, may result in rapid ice discharge when the surrounding ice shelves are weakened (Figure 2.36). The discharge of the WAIS is dominated by fast-flowing ice streams, and there have been speculations that these may speed up under certain circumstances. There is a considerable body of evidence for ice stream variability, but the extent to which this may contribute to overall volume changes of the WAIS is not clear.

Recent spectacular break-ups of the Larsen ice shelves in the Antarctic Peninsula demonstrate the existence of an abrupt thermal limit on ice shelf viability associated with regional atmospheric warming. The WAIS ice shelves,

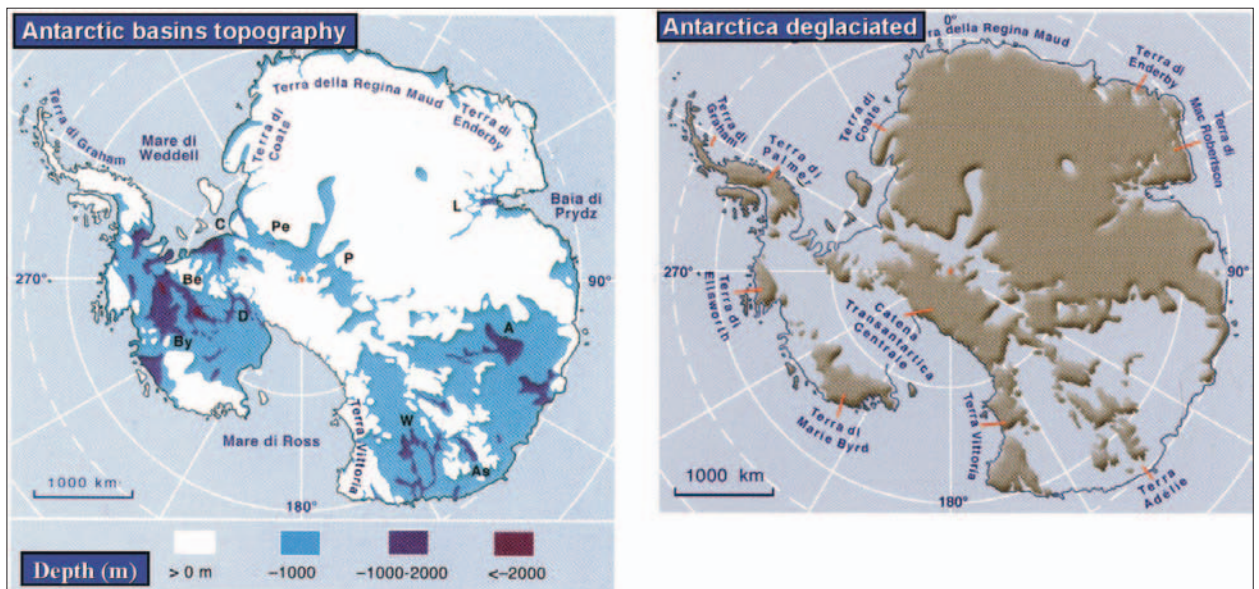

Figure 2.36 - Potential instability of the West Antarctic Ice Sheet (WAIS): The ice shelves fringing the coastal zones of Antarctica (not shown in the figure) are natural 'taps' of the Antarctic ice sheet system. They regulate the flow of continental ice towards the ocean and, correlatively, the amount of fresh water added to the ocean, eventually contributing to sea level rise. This in turn would result in reduced back stresses on the few 'pinning points' where the ice shelves are in contact with bedrock (see Figure 2.28), thus increasing continental ice flow rates and moving the grounding line further inland. The WAIS is mostly grounded below sea level. The figures (adapted from Manzani, 2001) show the depth of the ice-buried Antarctic basins (left) and what would result if all the area below present-day sea level was deglaciata (right). Although this is an oversimplified view that does not take into account the glacio-isostatic rebound (bedrock uplift as the ice burden disappears), it clearly illustrates how the processes described above could potentially destabilise the western part of the Antarctic ice sheet. (ULB-GLACIOL).

however, are not immediately threatened by this mechanism, which would require a further local warming of  $10^{\circ}\text{C}$  before the  $-5^{\circ}\text{C}$  mean annual isotherm reached their ice fronts.

It is now widely agreed that major loss of grounded ice from the WAIS, and accelerated sea level rise, is very unlikely during the 21<sup>st</sup> century, but on a longer time scale, changes in ice dynamics could result in significantly increased outflow of ice into the ice shelves and a grounding line retreat. Mechanisms have been investigated linking these phenomena to oceanic warming and basal melting below the ice shelves. Model studies indicate that even for moderate warming a large increase in bottom melting becomes the dominant factor in the longer-term response of the Antarctic ice sheet. The WAIS expert panel attributes a 50% probability to two different scenarios: (i) the WAIS might not make a significant contribution

to sea level rise on time scales of less than a millennium and (ii) the sea level rise will be larger than  $2\text{ mm/yr}$  after 1,000 years. These two scenarios with equal probability emphasise the inadequacy of our current understanding of the dynamics of the WAIS, especially for predictions on longer time scales.

Uncertainty in model prediction arises from complex interactions and feedback mechanisms between the ice sheet, its heat balance, and the underlying substrate. One such mechanism leads to limit-cycle behaviour, i.e. the ice sheet reaches a dynamic state that does not converge to a single solution but remains in a cyclic growth-shrink state. The process is shown below in Figure 2.37 by the result of two model runs, one without basal interaction and one where the ice sheet dynamics and heat balance interfere with the basal conditions (sliding and melting).

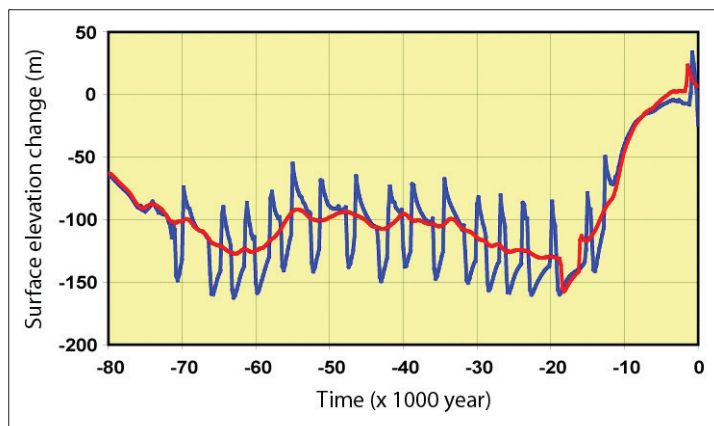

Figure 2.37 - Response of the ice sheet in Dronning Maud Land, Antarctica, to the climate signal over the last 80,000 years. The zero line on the Y-axis is the present surface elevation. The red line displays the reaction of the ice sheet (given as a change in surface elevation) when basal conditions, such as melting and basal sliding, are not supposed to interact with the ice sheet dynamics and heat balance. The blue line is the reaction of the ice sheet due to such complex interaction and feedback, resulting in high-frequency cyclic growth and decay of the ice sheet (limit cycles). Since such processes are highly non-linear, they make accurate predictions of ice sheet behaviour difficult. (VUB-DG).

### **The stability of thermohaline circulation**

A likely consequence of global warming is a partial melting of the Greenland ice sheet, resulting in a positive contribution to sea level change and a greater freshwater flux into the surrounding ocean. Over the past decade, various studies have been conducted with ice sheet models to quantify ice volume changes under specified climate change scenarios for the 21<sup>st</sup> century and beyond (see IPCC TAR - Climate Change 2001: The Scientific Basis (2001) for a review). In the most comprehensive assessments, the Greenland ice sheet is projected to be able to contribute up to 9 cm to global sea level rise by 2100, with the potential of a larger contribution afterwards if the warming were sustained beyond the 21<sup>st</sup> century. As the Greenland ice sheet lies close to the two main areas of North Atlantic deep-water formation, one can anticipate that it will

play a role in modulating the future strength of the oceanic thermohaline circulation. In order to evaluate this effect, a climate-change scenario identical to that described earlier was used with the CGCM coupled to a high-resolution (20 km, 31 levels) model of the Greenland ice sheet.

Because of the warming that enhances melting at the surface of the ice sheet, the total freshwater flux from Greenland to the ocean increases during the simulation. At the end of the 21<sup>st</sup> century, this flux appears strong enough to induce a strong and abrupt weakening of the oceanic thermohaline circulation and, consequently, a local cooling in the northern part of the North Atlantic. Such a breakdown of the oceanic thermohaline circulation is not reproduced in the simulation that does not include an interactive coupling with the Greenland ice sheet (Figure 2.38). This underlines the major role of the freshwater

flux from Greenland. Nevertheless, this result must be taken with caution. Firstly, the present-day climate is not perfectly reproduced by the model. Secondly, only one experiment has been conducted with an interactive ice sheet component and one experiment without this component. Recent studies performed with climate models of intermediate complexity have shown that the evolution of the oceanic thermohaline circulation close to a transition point is quite unpredictable. Consequently, a large number of experiments would be necessary to demonstrate that the difference of behaviour between the two simulations is robust and not simply due to chance. In any case, the magnitude of the freshwater perturbation coming from Greenland and its potential impact stress the need to include an interactive ice sheet component in order to provide reliable estimates of the evolution of the climate during the 21<sup>st</sup> century and beyond. Unfortunately, this is not yet done in the majority of models.

We also find abrupt events during the last glaciation. The response time of the Bidimensional Climate Model (Modèle Bidimensionnel Climatique, MoBidiC) to a freshwater input is shorter in a glacial climate than during an interglacial one. The thermohaline circulation recovers its initial state in two steps separated by about 1,470 years. Both steps come with an increase in Greenland temperature induced by massive release of the heat accumulated in the intermediate ocean.

Vegetation cover also played a role during the Eemian. According to the MoBidiC model results, precession was the main driver of climatic change during the last Interglacial. The model simulates an annual mean cooling of 5°C between 122-120,000 years ago. The feedback analysis reveals that synergy between snow and vegetation is crucial to the gradual settlement of perennial snow at northern high latitudes.

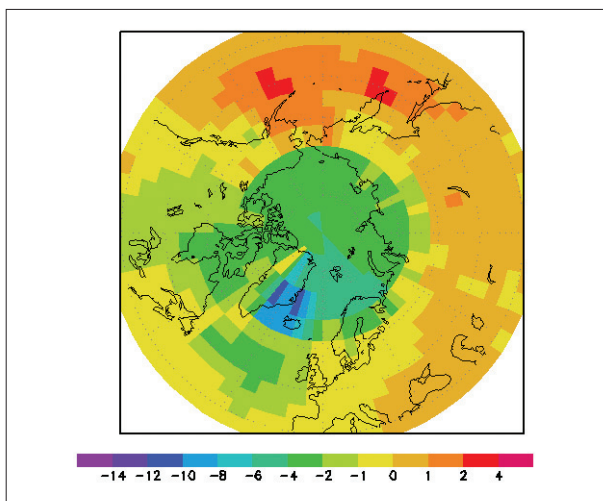

Figure 2.38 - Difference in annual mean surface air temperature averaged over years 2096-2100 (in °C) between two experiments driven by anthropogenic forcing deduced from one of the IPCC scenarios (SRES B2, see Box 2.1). The first experiment does not include an interactive ice sheet component whilst the second one does. In the latter experiment, the freshwater flux from Greenland is able to induce a slowdown of the oceanic thermohaline circulation, resulting in major cooling in the North Atlantic, in particular around Iceland. (UCL-ASTR).



### Biogeochemical surprises

Methane ( $\text{CH}_4$ ) hydrates have recently been suggested to play an important role in the natural greenhouse gas cycle, through their potential to sequester large amounts of methane in the continental margin or permafrost sediments and to release these large amounts suddenly into the atmosphere when destabilising

(possibly caused by climate or climate-related causes). Such a massive release would induce global warming. In order to better understand the processes by which this methane is released from gas hydrates in the geosphere into the atmosphere, they have to be studied in detail. Up to now, no examples are known of ongoing gas hydrate destabilisation, except possibly in

Lake Baikal (Siberia, Russia). The study of anomalous occurrences of hydrates in Lake Baikal suggests that local destabilisation of gas hydrates is taking place under the influence of geothermal anomalies (Figure 2.39). These areas are characterised by the presence of vigorous gas seeps (this is the first discovery of 'cold seeps' in a lacustrine environment and mud volcanism. Recent work has focused on analysing the fate of the released methane in the water column and on trying to quantify how much actually reaches the atmosphere. In Lake Baikal, it seems that the seep activity can be buffered entirely by the water column: oxidation and dissolution of methane, microbial activity, etc. Ongoing measurements will map the methane concentration in the water column and atmosphere in seep and non-seep areas. As a spin-off of this work, a new project has recently started to study the same process in the Black Sea, where the buffering effect of the water column – which is less oxidised – will be completely different.

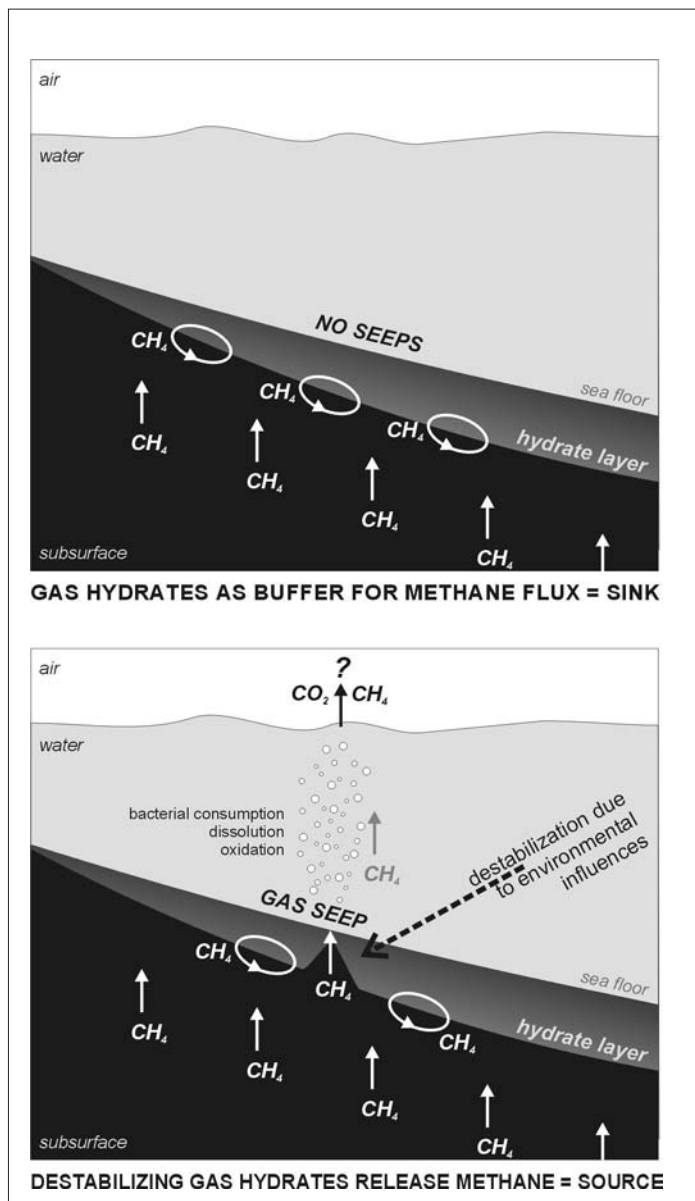

Figure 2.39 - Seismic cross section showing the location of a gas seep in Lake Baikal in its structural setting. Seeps are interpreted to result from local destabilisation of gas hydrates caused by a pulse of hydrothermal fluid flow along the active fault segment. (UGent-RCMG).

## 2.7 Will climate change affect atmospheric ozone?

Major processes by which both higher atmospheric (stratospheric) and lower atmospheric (tropospheric) ozone changes affect climate have been described in

Chapter 1. Interactions also work the other way, however, with climate changes impacting ozone concentrations and distributions in the stratosphere and troposphere.

### **2.7.1 Stratosphere**

The ozone depletion and greenhouse-warming phenomena share many common chemical and physical processes. For example, as the atmospheric abundances of the ozone-destroying chlorofluorocarbons (CFCs) decline thanks to enforcement of the provisions of the Montreal Protocol and its Amendments and Adjustments ('Montreal Protocol on Substances that deplete the Ozone Layer'), their contribution to greenhouse warming will decline too. On the other hand, use of hydrofluorocarbons (HFCs) and hydrochlorofluorocarbons (HCFCs), other important greenhouse gases, as substitutes for CFCs will cause the greenhouse-warming contributions of these new compounds to increase (this has been confirmed by global observations).

A number of models have been run to explore the feedback between climate and the ozone layer. They have shown that past changes in ozone have contributed, together with an increase of well-mixed greenhouse gases, to cooling of the stratosphere. Future changes in well-mixed greenhouse gases will affect the future evolution of the ozone abundance through chemical, radiative, and dynamic processes.

In this highly coupled system, attribution is difficult. Stratospheric cooling, mainly due to projected carbon dioxide increases, is predicted to enhance future ozone decreases in the upper polar stratosphere. Yet a reliable assessment of these effects on total-column ozone is limited by uncertainties regarding the lower stratospheric response to these changes. After all, general circulation models (GCMs) show that an increase in the abundance of atmospheric greenhouse gases creates a warmer troposphere and a colder

lower stratosphere. Further cooling of the lower stratosphere will attenuate ozone destruction caused by gas phase reactions involving chlorine and nitrogen compounds at mid-latitudes. On the other hand, this same lower stratospheric cooling will induce additional formation and further persistence of polar stratospheric clouds, responsible for the major winter ozone destruction over both the Arctic and the Antarctic. Finally, climate change will also affect stratospheric latitudinal transport, and thus the global distribution of ozone and ozone-destroying source gases in the upper atmosphere.

Whether or not climate change will affect recovery of the stratospheric ozone hole thus remains a key question. The most realistic range of model predictions indicates that ozone recovery is expected between 2030 and 2060, depending on the assumed future physical states and chemical composition of the atmosphere. It should be repeated that ozone and climate change depend on a number of common physical and chemical processes that are coupled themselves. Both are affected by anthropogenic increases in numerous source gases with great ozone-depleting and high global warming potentials. Hence, the aims of the Montreal Protocol and Kyoto Protocol are intimately related, the latter being deeply concerned with the environmental impacts of new compounds adopted as substitutes for those banned by the Montreal Protocol.

### **2.7.2 Troposphere**

Climate change will also lead to a wide set of changes affecting global air quality. As the number of potential climate change impacts is large, only the most important ones will be described.

Biomass-burning emissions are considered to contribute significantly to tropospheric ozone formation. The dominant natural factors controlling the amount of biomass burned, are

the amount of fuel available (plant litter, twigs, small stems), the dryness of the soil and vegetation, temperature, and wind speed. As climate change will lead to prolonged dryness in some regions, there will be more frequent years with high fire occurrence. What is more, simulations with a GCM suggests a significant increase in lightning activity under 'doubled CO<sub>2</sub>' conditions, which would substantially increase the burnt area and the related biomass-burning emissions (CO, NO<sub>x</sub>, CH<sub>4</sub>).

Natural emissions of compounds can significantly affect the distribution of tropospheric ozone. Soils are an important source of N<sub>2</sub>O and NO, through microbial nitrification and denitrification processes. These processes are influenced by soil environmental conditions such as soil temperature, moisture, fertility, and vegetation cover, which in turn are also affected by climate change. It is further expected that production of NO in lightning discharges, which are highly sensitive to climate change, will increase.

Wetlands and unstable methane hydrates constitute a third type of natural source of ozone precursor gases. Key factors that determine wetland methane emissions are wetland area, the water table level, temperature, and various soil and vegetation characteristics. It is clear that any change in the climate pattern will have its effects on wetland methane emissions.

The relatively unstable methane hydrates are natural gas locked within ice-like material at the bottom of oceans and permafrost. Changes in ocean temperature or circulation or sudden melting of permafrost could release this methane into the atmosphere and substantially influence atmospheric chemistry.

Other important ozone precursors are the highly reactive volatile organic compounds (VOCs). Emission rates of biogenic VOCs are highly variable among different plant species and are also strongly dependent on meteorological

conditions.

Oceans emit particulate precursor gases such as sulphur-containing gases (e.g., dimethyl sulphide, DMS) that are oxidised to SO<sub>2</sub> and further to sulphate aerosols. DMS may thus lead to changes in aerosol and cloud occurrence, which in turn influences tropospheric ozone concentrations through heterogeneous chemistry and by changing photolysis rates. The production of sea-salt aerosols increases strongly with wind speed and may thus have a (probably negative) impact on ozone formation. The same is true of the expected climate-induced increase in mineral aerosol (dust) concentrations.

Both dry deposition, the irreversible removal of gases and aerosols at the earth's surface, and wet deposition, the scavenging by rain and snow, provide an important sink for ozone and some precursor gases. The effect of climate change through dry and wet deposition is probably negative and is region-dependent.

Increased humidity will also increase concentrations of hydroxyl (OH), the most efficient oxidising compound in the atmosphere. This influences significantly the lifetime of ozone precursor gases. The chemical ozone production and ozone loss terms will also be affected by climate change.

Finally, climate changes will influence ozone transport. Tropospheric ozone is affected by the influx of stratospheric ozone-rich air. This source is expected to change in the future, depending on stratospheric ozone concentrations (which are thought to increase) and on the magnitude of transport between the troposphere and the stratosphere. It is expected that the downward flux of (ozone-rich) air from the stratosphere to the troposphere will increase in a warmer climate, leading to higher tropospheric ozone concentrations. Local and large-scale weather patterns (e.g., North Atlantic Oscillation, NAO; and El Niño Southern Oscillation, ENSO) also

affect the global distribution of tropospheric ozone by providing pathways for the transport of ozone and its precursors from the lower troposphere to the free troposphere.

It can be concluded that climate change affects a large number of processes which all act together to determine the global ozone budget. It is important, however, to state that the possible impacts mentioned are rather speculative, inherently difficult to quantify, and based on incomplete knowledge of the climate-related processes that might impact ozone concentrations.

## **2.8 Will the Kyoto Protocol save the climate?**

### **2.8.1 Why does the climate need to be saved?**

The IPCC projects that climatic changes will intensify in the coming decades and centuries. They might represent both opportunities and risks for human development. Opportunities could be opened, for example, for some periods in regions where agriculture is presently limited by low temperature. Thinning of the Arctic sea ice might allow surface navigation in areas that were accessible only to submarines. The increase in winter temperature could decrease mortality due to cold spells. Yet the risk of negative impacts, on balance, is likely to be much greater than the few positive effects. Projected adverse impacts based on models and other studies include: a general reduction of potential crop yields in most tropical and sub-tropical regions for most projected increases in temperature; a general reduction, with some variation, of potential crop yields in most regions at mid-latitudes for increases in annual-average temperature of more than 2-3°C; decreased water availability for populations in many water-scarce regions, particularly in the sub-tropics; an increase in the number of people exposed to vector-borne diseases (e.g., malaria) and

water-borne diseases (e.g., cholera), and an increase in heat stress mortality; a widespread increase in the risk of flooding for many human settlements (tens of millions of inhabitants in the settlements studied) from both increased heavy precipitation events and sea level rise.

The international community does clearly recognise that the potential opportunities that climatic change offers for human development do not compensate for the risks that it represents. This is recognised by the existence of the UN Framework Convention on Climate Change (UNFCCC, 1992). Those risks are classified in the Article 2 of the UNFCCC, which describes the Convention's ultimate objective: "stabilisation of greenhouse gas concentrations at a level that would prevent dangerous anthropogenic interference with the climate system."

#### ***What is dangerous?***

The text of the Convention does not contain any quantification of this level, but Article 2 indicates that three areas need to be considered when determining the 'non-dangerous' level and rate of change: "to allow ecosystems to adapt naturally to climate change, to ensure that food production is not threatened, and to enable economic development to proceed in a sustainable manner". It is with at least these criteria in mind that the objective of saving the climate needs to be assessed, while recognising that other factors and criteria may also need to be considered.

How can science help? The IPCC TAR recognises that "natural, technical, and social sciences can provide essential information and evidence needed for decisions on what constitutes "dangerous anthropogenic interference" with the climate system. At the same time, such decisions are value judgments determined through socio-political processes, taking into account considerations such as development, equity, and sustainability, as well

as uncertainties and risk. Scientific evidence helps to reduce uncertainty and increase knowledge, and can serve as an input for considering precautionary measures." So,

science can shed some light on the problem, but not provide alone the concentration range that should be considered 'dangerous'.

### Box 2.2 - Examples of vulnerable physical systems

Greenhouse gas forcing beyond the 21<sup>st</sup> century could set in motion long-term effects and irreversible changes in some physical systems. The systems below have been studied by Belgian researchers.

#### The Greenland ice sheet

The Greenland ice sheet will continue to respond to climate change over the next several thousands of years, even if the climate is stabilised. The ice sheet is vulnerable to climatic warming because, even with moderate warming, surface melting will increase so far as to exceed accumulation, in which case the ice sheet cannot survive. This situation occurs by the year 3000 with an annual-average warming of about 3°C. Under these circumstances, the Greenland ice sheet eventually disappears, except for residual glaciers at high altitudes. Models project that a local annual-average warming exceeding 3°C, sustained for millennia, would lead to virtually complete melting of the Greenland ice sheet with a resulting sea level rise of 7 m (Figure 2.40). Projected temperature rises over Greenland are generally higher than globally averaged values by a factor of 1.2 to 3.1. For a warming over Greenland of 5.5°C, consistent with mid-range stabilisation scenarios, the Greenland ice sheet is likely to contribute about 3 m in 1,000 years. For a local warming of 8°C, the contribution is about 6 m, the ice sheet being largely eliminated. For lesser

warming, the decay of the ice sheet would be substantially slower.

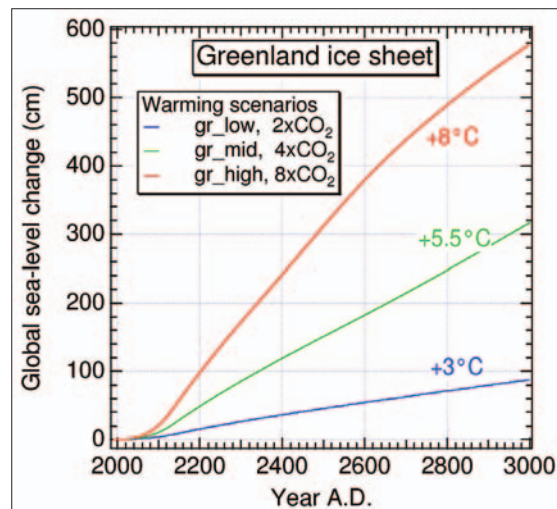

Figure 2.40 - Response of the Greenland ice sheet to three climatic warming scenarios during the third millennium, expressed in equivalent changes in sea level. The curve labels refer to the mean annual temperature rise over Greenland by the year 3000. Note that projected temperature rises over Greenland are higher than the globally averaged temperature rises by a factor of 1.2 to 3.1. (VUB-DG).

#### The ice cover at the South Pole

The response of the Southern Ocean to an increase in atmospheric greenhouse gas concentrations, simulated by a global atmosphere-ocean-sea-ice model, can be decomposed into two different phases. First, the ocean damps surface warming because of its large heat capacity. Next, one century after the major increase in greenhouse gases, the warming is amplified because of a positive feedback associated

with a stronger oceanic meridional heat transport toward the Southern Ocean. The amplification phase, responsible for a major decrease in ice area in the Southern Ocean, takes place one or even a few centuries after the major increase in greenhouse gas concentrations (Figure 2.41). This has consequences for the interpretation of both observations and model results. In particular, the attribution of present-day observed changes to the increase in greenhouse gas concentrations is quite complex in the Southern Ocean, as the major part of the response to the perturbation has probably not yet occurred.

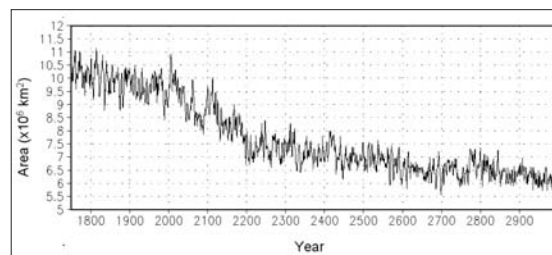

Figure 2.41 - Time evolution (years) of the annual mean sea ice area ( $10^6 \text{ km}^2$ ) in the southern hemisphere as simulated by a climate model driven by the observed increase in greenhouse gases over the period 1750-2000. During the third millennium, the concentration in greenhouse gases is maintained constant at the value observed in the year 2000. Even in this unrealistically optimistic case, the simulation shows a major decrease in ice extent in the third millennium. (UCL-ASTR).

### ***The lower the concentration, the lower the risk***

In order to facilitate eventual decisions about the 'dangerous level', the impacts of projected climate changes have been summarised by the IPCC in terms of five risk categories, or 'reasons for concern'. Figure 2.42 clearly shows that the risks of adverse impacts from climate change increase with the magnitude of climate change. It also suggests that, even at the lower end of the projections, some unique and threatened ecosystems will disappear and some regions will be exposed to adverse impacts. In the mid-range, many unique systems may be at risk and the impact of extreme events should rise, developing countries being hurt most although the impact on the aggregate global economy (counting only what can be monetised) might still be modest. Changes towards the upper end pose risks to all and the risk of large-scale abrupt disruptions becomes significant.

Each risk category is perceived differently by the various actors and countries, according to their interests and values. There is presently no

international consensus on the level of climate change or greenhouse gas concentration that should be considered dangerous. The Council of Ministers of the European Union, however, adopted an official position in 1996: "Given the serious risk of such an increase and particularly the very high rate of change, the Council believes that global average temperatures should not exceed 2 degrees (Celsius) above pre-industrial level (...)"

To answer the question of whether the Kyoto Protocol will save the climate, we will therefore assume below that 'saving the climate' means implementing the European Union objective.

### **2.8.2 Inertia between emissions and temperature**

To assess changes in emission trajectories that would be needed to stabilise the climate and prevent the global average temperature from increasing by more than  $2^\circ\text{C}$  above the pre-industrial level, it is necessary to understand the chain of causes and effects between emissions and global temperature, and to identify the

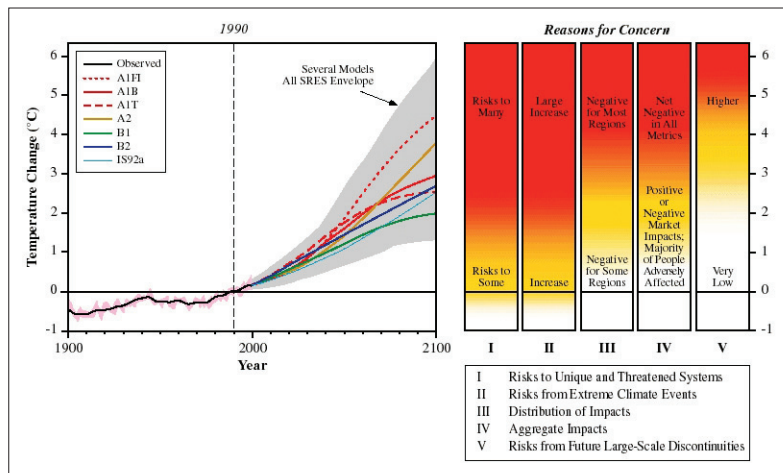

Figure 2.42 - Reasons for concern about projected climate change impacts. The risks of adverse impacts from climate change increase with the magnitude of climate change. The left part of the figure displays the observed temperature increase relative to 1990 and the range of projected temperature increase after 1990 as estimated by IPCC's Working Group I for scenarios from the Special Report on Emissions Scenarios (IPCC SRES, 2000). The right panel displays conceptualisations of five reasons for concern regarding climate change risks evolving through 2100. White indicates neutral or small negative or positive impacts or risks, yellow indicates negative impacts for some systems or low risks, and red means negative impacts or risks that are more widespread and/or greater in magnitude. The assessment of impacts or risks takes into account only the magnitude of change and not the rate of change. Global mean annual temperature change is used in the figure as a proxy for the magnitude of climate change, but projected impacts will be a function of, among other factors, the magnitude and rate of global and regional changes in mean climate, climate variability and extreme climate phenomena, social and economic conditions, and adaptation (IPCC-Climate Change 2001: Impacts, Adaptation and Vulnerability).

sources of inertia in the climate system. Inertia is a widespread inherent characteristic of the interacting climate, ecological, and socio-economic systems. Thus, some impacts of anthropogenic climate change may be slow to become apparent, and some could be irreversible if climate change is not limited in both rate and magnitude before associated

thresholds, whose positions may be poorly known, are crossed.

As explained in Section 2.3, emissions of greenhouse gases affect their concentration in the atmosphere, which in turn affects global radiative forcing and causes global warming. The combined effect of the interacting inertias of the various component processes is such that stabilisation of the climate and climate-impacted

systems will not be achieved until long after anthropogenic emissions of greenhouse gases have been reduced. The perturbation of the atmosphere and oceans resulting from CO<sub>2</sub> already emitted due to human activities since 1750 will persist for centuries because of the slow redistribution of carbon between large ocean and terrestrial reservoirs with slow turnover (Figure 2.43). The future atmospheric concentration of CO<sub>2</sub> is projected to remain for centuries near the highest level reached, since natural processes can return the concentration to pre-industrial levels only on a geological time scale. In contrast, stabilisation of emissions of shorter-lived greenhouse gases such as CH<sub>4</sub> (methane) leads within decades to stabilisation of atmospheric concentrations. Inertia also implies that avoidance of emissions of long-lived greenhouse gases has long-lasting benefits.

The oceans and cryosphere (ice caps, ice sheets, glaciers, and permafrost) are the main sources of physical inertia in the climate system on a time scale of one to ten millennia (see Box 2.2). Due to the large mass, thickness, and thermal capacity of the oceans and cryosphere, and to the slowness of the heat transport process, linked ocean-climate models predict that the average temperature of the atmosphere near the earth's surface will take hundreds of years to finally approach the new 'equilibrium' temperature following a change in

radiative forcing. Penetration of heat from the atmosphere into the upper 'mixed layer' of the ocean occurs within decades, but transport of heat into the deep ocean requires centuries. An associated consequence is that human-induced sea level rise will continue inexorably for many centuries after the atmospheric concentration of greenhouse gases has been stabilised.

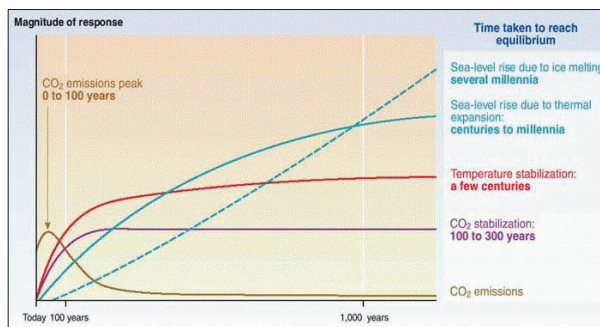

Figure 2.43 –  $\text{CO}_2$ -concentration, temperature, and sea level continue to rise long after emissions are reduced. After  $\text{CO}_2$  emissions are reduced and atmospheric concentrations stabilise, surface air temperature continues to rise slowly for a century or more. Thermal expansion of the ocean continues long after  $\text{CO}_2$  emissions have been reduced, and melting of ice sheets continues to contribute to sea level rise for many centuries. This figure is a generic illustration for stabilisation at any level between 450 and 1,000 ppm, and therefore has no units on the response axis. Responses to stabilisation trajectories in this range show broadly similar time courses, but the impacts become progressively larger at higher concentrations of  $\text{CO}_2$ . (IPCC TAR - Climate Change 2001: The Scientific Basis).

### 2.8.3 Kyoto and climate stabilisation

Future climate change is determined by historic, current, and future emissions. The projected rate and magnitude of warming and sea level rise can be lessened by reducing greenhouse gas emissions. As shown in Figure 2.44, the greater the reductions in emissions are and the earlier they are introduced, the smaller and slower the projected warming and sea level rise will be. For example, for the most important anthropogenic greenhouse gas  $\text{CO}_2$ , carbon cycle models indicate that to stabilise

atmospheric  $\text{CO}_2$  concentrations at 450, 650 or 1,000 ppm, it would be necessary to reduce

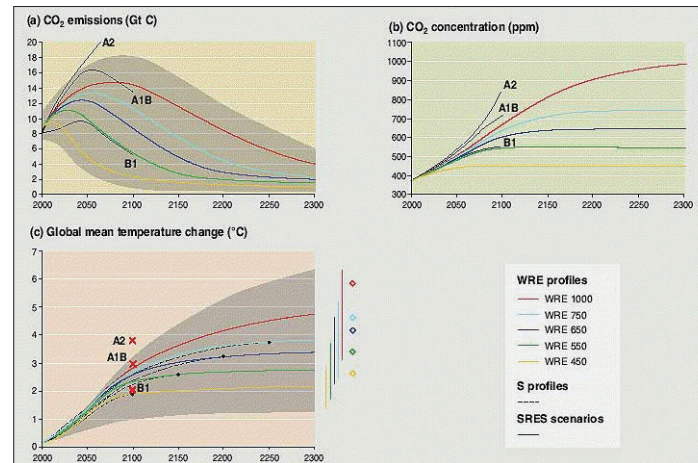

Figure 2.44 – Emissions, concentrations and temperature changes corresponding to different stabilisation levels for  $\text{CO}_2$  concentrations. Stabilising  $\text{CO}_2$  concentrations would require substantial reduction of emissions below current levels and would slow the rate of warming.

$\text{CO}_2$  emissions: the time paths of  $\text{CO}_2$  emissions that would lead to stabilisation of the concentration of  $\text{CO}_2$  in the atmosphere at various levels are estimated for the stabilisation profiles designed by Wigley, Richels, and Edmonds (WRE) using carbon cycle models. The shaded area illustrates the range of uncertainty.

$\text{CO}_2$  concentrations: the  $\text{CO}_2$  concentrations specified for the WRE profiles are shown. c) Global mean temperature changes: temperature changes are estimated using a simple climate model for the WRE stabilisation profiles. Warming continues after the time at which the  $\text{CO}_2$  concentration is stabilised (indicated by black spots), but at a much-diminished rate. It is assumed that emissions of gases other than  $\text{CO}_2$  follow the middle of the range of IPCC scenario projections until the year 2100 and are constant thereafter. The shaded area illustrates the effect of a range of climate sensitivity across the five stabilisation cases. The coloured bars on the right-hand side show uncertainty for each stabilisation case at the year 2300. The diamonds on the right-hand side show the average equilibrium (very long-term) warming for each  $\text{CO}_2$  stabilisation level. Also shown for comparison are  $\text{CO}_2$  emissions, concentrations, and temperature changes for three of the IPCC SRES scenarios. (IPCC-Climate Change 2001: Synthesis Report).



global anthropogenic CO<sub>2</sub> emissions to below the year-1990 levels within, respectively, a few decades, about a century or about two centuries, and to maintain steady reduction of emissions thereafter. These models illustrate that emissions would peak in about 1 to 2 decades (450 ppm) or within roughly a century (1,000 ppm). Eventually CO<sub>2</sub> emissions would need to decline to a very small fraction of current emissions.

### ***Kyoto: An important first step***

The Kyoto Protocol to the UNFCCC, adopted in 1997, aims to reduce greenhouse gas emissions in developed countries by 5% between 1990 and the 2008-2012 period. In the light of the above figures, this is far from what is needed to 'save' the climate and maintain the temperature increase below 2°C above the pre-industrial temperature. It has been estimated that if the Kyoto Protocol were fully implemented by all developed countries, the CO<sub>2</sub> concentration in 2010 would only be 1 to 1.5 ppm below what would have happened anyway without the Protocol. Yet as expressed by Prof. Bolin, former Chairman of the IPCC, "because of the long residence time of CO<sub>2</sub> in the atmosphere, even a modest reduction in the rate of increase of atmospheric CO<sub>2</sub> would be of long-term significance." Indeed, differences in projected temperature changes between scenarios that include greenhouse gas emission reductions and those that do not, tend to be small for the first few decades. The differences grow with time if the reductions are sustained. The Kyoto Protocol is therefore an important step on the way to climate protection, also because it will allow a lot of 'learning by doing'. But many other steps will be needed.

## **2.9 Where has Belgian research made a difference in the international effort?**

Below, some examples of key scientific Belgian contributions to various topics in the domain of climate and climate change are detailed. It concerns expertise of Belgian research teams and outcomes from networking projects funded by BELSPO.

### ***Research networks***

ENSO (Recent ENSO and Palaeo-ENSO of the last 1000 years in Lake Tanganyika)

Major findings of ENSO (members: KMMA / MRAC, UGent-PAE, UCL-GEOG, UCL-GEOL) were:

- ✓ Significant ENSO teleconnections with average, maximum, and minimum air temperature, humidity, rainfall, winds, air pressure, and radiation in East Africa. The strongest teleconnections were found between monthly air temperature anomalies and sea surface temperature anomalies in the West Equatorial Pacific Ocean. During ENSO events, winds decreased but air pressure and radiation increased. The average air temperature increase was +0.28°C and could reach +0.8°C as observed during strong El Niño events of the last 30 years. Results from a reconstruction of the stability of the water column over the last 40 years suggest a ± 20% variability of the stability of the upper 100 m of Lake Tanganyika. Catches of the main pelagic fishes correlated particularly with ENSO over the last 30 years at two lake stations.
- ✓ Because not all different variables are teleconnected to ENSO in the same way, this leads to a complex impact of ENSO on

ecosystems. It appears that the direction, magnitude and timing of this impact are controlled by the climate system on a regional scale and on a more local scale. Surface attributes, as determined by geology, soil, and vegetation, might also influence the magnitude and time lag of the ENSO impact.

- ✓ A rise in air temperature at Lake Tanganyika in recent decades (>0.7-0.9°C). This was apparently linked to a water temperature increase and to greater stability of the lake. Decreased winds and changes in fish catches were observed over the same period for sardines and one species of perch. These observations suggest that the lake is sensitive to the recent global temperature increase and has probably been sensitive to past climate variability as well.

#### **CALMARS (Calcareous Marine Skeletons)**

CALMARS (members: IRSNB / KBIN-invertebrates, KMMA / MRAC, ULB-BIOMAR, VUB-ANCH, UA-EFB) is studying marine calcareous skeletons (selected among sclerosponges, bivalves and echinoderms) as recorders of global climate change in the North East Atlantic Ocean and Caribbean. CALMARS aims to improve and extend records of global change in the oceanic domain, with emphasis on climate databases.

#### **CLIMLAKE (Climate variability as recorded in Lake Tanganyika)**

CLIMLAKE (members: FUNDP-URBO, UGent-PAE, KMMA / MRAC, UCL-ASTR) is studying the ENSO-related variability of hydrodynamics and plankton productivity in Lake Tanganyika (East Africa), which will ultimately be incorporated into a 3-D ECO-HYDRO-model. This model will link lake movements with changes in organisms in the lake. Environmental and climate changes that occurred over the

past 1,500 years at Lake Tanganyika will be investigated using the model coupled with the sediment proxies of the lake. A comparison will be made with the climate variability studied in other areas of the world over the same period. One of the preliminary results of this project will lead to the development of a policy-supporting tool for the fisheries departments near African rift lakes. For this purpose, the network CLIMFISH is under construction.

#### **ENSO-CHILI (A continuous Holocene record of ENSO variability in Southern Chile - A clue to a better understanding of interhemispheric climate teleconnections)**

ENSO-CHILI (members: UGent-RCMG, ULg-URAP and UCL-ASTR) analyses the sedimentary records in two Chilean lake basins aiming to assess whether events like ENSO have been recorded in these lakes, to identify connections between the records, to determine whether the recorded variations are global or local, and to confront our observations and results with existing climate models.

Sediment cores were selected from the lakes. A multi-disciplinary analysis of these cores (including physical properties, sedimentology, age dating, tephrochronology, palynology and mathematical treatment) with a basin-wide interpretation of the spatial and temporal evolution of the sedimentary environment is in progress. The expected outcome of the project will be a well-dated, multi-proxy record - at high resolution - of variations in terrigenous sediment supply and of vegetation changes during the Holocene. Such a record will be instrumental in improving the knowledge of the natural cyclicities of the world's climate system and on how and how fast specific climate changes may have a global impact. Improved knowledge of the natural climate cycles (new cycles at various time scales are increasingly being detected) is required in order to better assess and evaluate

the potential impacts of man on the environment and climate, and to better define measures to be taken, at international level, to control this human impact.

#### **LAQUAN (Late Quaternary climate history of coastal Antarctic environments: a multi-proxy approach)**

LAQUAN (members: <sup>ULg</sup>-CIP, <sup>UGent</sup>-PAE) has recently reconstructed the history of relative sea level change in the Larsemann Hills region (Antarctica), making it possible to infer regional changes in continental ice sheet thickness and the timing of ice sheet retreat. This will be useful in validating models of ice sheet dynamics. UV-protective pigments, combined with fossil DNA, microfossils, and chemical proxies in laminated lacustrine sediments are being used to reconstruct the history of UV radiation. This approach is also used in a study of sub-glacial lacustrine communities in coastal Antarctica, providing an analogue for the exploration of inland sub-glacial lakes.

#### **AMICS (Antarctic ice-sheet dynamics and climatic change: Modelling and Ice Composition Studies)**

AMICS (members: VUB-DG, ULB-GLACIOL) contributes to the international research effort leading to an improved understanding of the dynamic behaviour of the Antarctic ice sheet resulting from climatic change. It aims at a better knowledge of the internal dynamics of the Antarctic ice sheet and to a better assessment of the interactions of the ice sheet with its boundary conditions. Therefore, it will develop a numerical model to translate the results of the ice-composition analyses into physical processes, hence providing the scientific community with a model tool of complex basal interaction. As basal processes play an important role in the onset of fast-flowing areas such as ice streams, the role

of ice streams, outlet glaciers and ice shelves in the stability of the Antarctic ice sheet and their influence on the variability of the ice sheet with changing climate will be investigated.

Both research teams are involved in the ongoing EPICA project (European Project for Ice Coring in Antarctica).

#### **MILMO (Modelling the evolution of climate and sea level over the third millennium)**

MILMO (members: UCL-ASTR, VUB-DG, ULg-LPAP) develops a three-dimensional global model of the Earth system suitable for studying the longterm evolution of climate (LOVECLIM). This model is made up of a coarse-resolution three-dimensional atmosphere-sea-ice-ocean model (ECBILT-CLIO), a dynamical model of the continental biosphere (VECODE), a comprehensive model of the oceanic carbon cycle (LOCH), and a high-resolution thermomechanical model of the Greenland and Antarctic ice sheets (AGISM).

Once validated, the model will be utilised to advance our understanding of interactions in the climate system, to improve climate-change projections at the century time scale and beyond, and to explore the threat of possible rapid climate and sea-level changes during the third millennium. It is also planned to incorporate the outcomes of MILMO's projections of climate and sea-level changes in international climatic databases such as the IPCC's one.

#### **CLIMOD (Climate Modelling: Modelling the climate and its evolution at the global and regional scales)**

CLIMOD (members: UCL-ASTR, VUB-DG, IRM / KMI) improved the physics of a coupled atmosphere-ocean general circulation model (AOGCM), a regional atmospheric model (MAR, Modèle Atmosphérique Régional), and a Greenland ice-sheet model (GISM) in line with the latest advances of the climate science.

AOGCM and GISM have been coupled together and forced by the IPCC- SRES B2 scenario. It simulates for the end of the next century a global surface warming of 2.3°C; a global increase in precipitation of 3%; and a rise in sea-level due to thermal expansion that reaches 22 cm in 2100, whereby the partial melting of the Greenland ice sheet induces an additional rise in sea level of 4 cm.

CLIMOD also produced a high-quality (homogeneous) regional climatic database for Belgium from observational data covering the last few decades. The analysis demonstrates for example that:

- ✓ the extreme temperatures exhibit a warming trend of 2–2.5°C per century over the last 50 years, mainly in summer;
- ✓ a particularly warm period started abruptly after 1988;
- ✓ the most significant regional warming trends are observed in the coastal regions for the maximum temperature, and in the central part of the country and in regions of highest altitude for the minimum temperature;
- ✓ no significant trend was detected regarding the annual mean precipitation; and
- ✓ the minimum temperature shows an overall warming trend over the country of 0.9°C per century, with an abrupt increase around 1988. The results for the maximum temperature are less clear.

The database is a valuable tool to evaluate the performance of regional climate models over Belgium.

#### **Research teams:**

##### **UCL-ASTR**

Within the framework of ENSO-CHILI, CLIMLAKE, CLIMOD and MILMO, UCL-ASTR

has developed various models of the climate system. With these models it is possible to gain a deeper understanding of some important mechanisms that drive the climate system and thus to reduce uncertainties about past, present, and future climate behaviour. Among these activities, the following should be underlined:

- ✓ Reproducing the strong Katabatic winds along the polar ice slopes of Antarctica with a dynamic atmospheric model (MAR, Modèle Atmosphérique Régional) which is very useful for the simulation of interactions between the lower atmosphere and the upper ice layers of the polar ice sheets.
- ✓ Identifying the processes that drive the variability of sea ice extent and volume in both hemispheres in order to help distinguish between the natural variability of the system and the response to the warming observed over the last 50 years.
- ✓ Simulating the response of the climate system to both anthropogenic and natural forcings in the second millennium has shown that one of the models is able to reproduce well the hemispheric-scale, low-frequency evolution of surface temperature obtained in various climate reconstructions. Furthermore, these numerical experiments show that without including anthropogenic forcings, it is not possible to simulate the warming observed over the 20<sup>th</sup> century, meaning that natural forcing and climate variability alone cannot explain the observed temperature rise.
- ✓ Analysing potential changes in oceanic thermohaline circulation in response to perturbations and the consequences of these changes on the climate of Europe and Greenland. This work includes the response to freshwater perturbations during the early Holocene, to variations of solar forcing, and to an increase in greenhouse

gas concentration. In the latter case, it has been possible to show that melting of Greenland ice could induce a reorganisation of the oceanic thermohaline circulation at the end of the 21<sup>st</sup> century that would have a major impact on surface temperature.

### UGent-RCMG

UGent-RCMG (currently a member of the ENSO-CHILI has demonstrated that in Lake Baikal (Siberia, Russia) hydrate destabilisation is actively taking place, the first-ever discovery of cold methane seeps in a lacustrine environment. It has conducted a quantitative study of methane fluxes in such an area of hydrate destabilisation (fluxes at the lake floor, in the water column, and at the lake/air interface), extending this research to the Black Sea and all methane fluxes from the subsurface, through the water column, and into the atmosphere, with effects on regional climate.

### ULB-GLACIOL

ULB-GLACIOL (currently a member of the AMICS networking project) is addressing the global change problematic by studying different aspects of the cryosphere. More specifically, most of its research efforts deal with the composition of ice masses at different interfaces (ice-bedrock or ice-water bodies), as a tool for determining their initial and boundary conditions in a dynamic and palaeo-environmental perspective. Ice composition is determined by multi-parametric analyses of ice samples (gas content and composition, stable isotope composition, major ion concentrations, ice fabric and texture). These parameters considered together make it possible to reconstruct the origin and evolution of the studied ice.

ULB-GLACIOL has directly provided the scientific community with findings on, and

answers or contributions to answers to, among others, the following general questions:

- ✓ What were the environmental conditions during the initial build-up of the Greenland ice sheet?
- ✓ Did abrupt climatic changes occur during the previous glacial and interglacial cycles (GRIP core: Greenland Ice Core Project)?
- ✓ What are the boundary conditions of different Antarctic ice sheets at their interface with water bodies (lakes: Vostok sub-glacial lake, Dry Valleys perennially frozen, proglacial, and marginal lakes; ocean: Nansen Ice Shelf and Hells Gate Ice Shelf)?
- ✓ What are the ice/ocean interaction processes controlling ice-shelf equilibrium in Antarctica, particularly at grounding lines and in frontal rifts?

In this context, several models and methods have been developed, for instance:

- ✓ Model for the origin of the deepest part of the Vostok ice core and the water in the sub-glacial lake Vostok.
- ✓ Model for quantifying marine ice production in ice-shelf rifts.
- ✓ Model for multiple ice deformation processes at the ice/bedrock interface of the Greenland ice sheet (implications for long-term chronology from dynamic models).
- ✓ Method for determining the sea ice growth rate and energy fluxes from the chemical and isotopic composition of the ice.
- ✓ Method for determining the hydrostatic or non-hydrostatic response of ice shelves to tidal pulses from detailed GPS measurements.

### Ulg-URAP

Ulg-URAP, a member of ENSO-CHILI,

studies the minerogenic component of continental (lake, peat) and marine quaternary sedimentary records, e.g., in Northern North Atlantic, Lake Baikal or in Chilean Lake District. The origin of detrital supplies, the transport agent and the detrital fluxes are interpreted in terms of palaeo-environmental and palaeoclimate changes, which are useful for validation of predictive climate models. Within ENSO-CHILI, a sedimentary core of one lake in South Chili allows to reconstruct the evolution of El Niño throughout the Holocene.

### VUB-DG

Within the framework of the MILMO, AMICS and CLIMOD networking projects, VUB-DG has contributed to Belgian Antarctic and global change research involving the development of 3-dimensional thermo mechanical ice-sheet/mass-balance/lithosphere models. These models have been successfully applied to the Antarctic ice sheet, the Greenland ice sheet, and the Quaternary ice sheets of the northern hemisphere for the ice ages. They have made it possible to investigate the form, extent, and physical characteristics of these ice sheets on time scales ranging from their inception during the Tertiary through the Quaternary glacial cycles, and also their response to future greenhouse warming. In more recent years, these models have been integrated into General Circulation Models (GCMs) and Earth System Models (ESMs) to investigate interactions and feedbacks between the continental cryosphere and the atmosphere and oceans. These models have also been used to help with locating and interpreting ice cores, and to disentangle ice mass and postglacial rebound trends from satellite gravity and altimetry records.

Key scientific findings include the role of environmental forcing in explaining ice sheet changes inferred from glacial-geomorphological findings, in reconstructing the sea level

contribution of the polar ice sheets during the ice ages, and in estimating freshwater fluxes arising from ice sheet melting and iceberg calving. The Greenland and Antarctic models developed were also used to make sea level projections for the polar ice sheets over the 21<sup>st</sup> century for the IPCC Second and Third Assessment Reports (IPCC SAR, IPCC TAR).

Other key research contributions of the VUB-DG are its Antarctic research activities, including:

- ✓ the development of complex 2-D and 3-D models for understanding ice stream behaviour and the interaction with basal conditions;
- ✓ modelling of the ice sheet in Dronning Maud Land, in support of palaeo-reconstruction and ice core drilling (European Project for Ice Coring in Antarctica, EPICA); and
- ✓ analysis of outlet glacier dynamics and mass balance based on field work and interferometry, contributing to international databases on Antarctic sub-glacial topography (Antarctic Bed Mapping, BEDMAP) and ice dynamics (Antarctic Ice Velocity Data, VELMAP).

Apart from Antarctic research, VUB-DG is also involved in assessing the response of temperate glaciers (Asia, Alps) to changing climate, through field work and modelling.

## 2.10 Key uncertainties to be addressed

---

Significant progress has been made according to the IPCC Third Assessment Report (IPCC TAR) in many aspects of the knowledge required to understand climate change and the human response to it. The IPCC has identified the following important areas where further work is required at the international level (citation

## Climate Change

from the IPCC TAR - Climate Change 2001: Synthesis Report):

- ✓ Detection and attribution of climate change.
- ✓ Understanding and prediction of regional changes in climate and climate extremes.
- ✓ Quantification of climate change impacts at the global, regional, and local levels.
- ✓ Analysis of adaptation and mitigation activities.
- ✓ Integration of all aspects of the climate change issue into strategies for sustainable development.
- ✓ Comprehensive and integrated investigations to support judgment as to what constitutes 'dangerous anthropogenic interference with the climate system'.

In the area covered by IPCC Working Group I, Box 2.3 represents the high-priority areas for action that were identified:

### Box 2.3 - High-priority areas for action (from IPCC TAR Climate Change 2001: The Scientific Basis)

#### Systematic observations and reconstructions:

- Reversing the decline of observational networks in many parts of the world.
- Sustaining and expanding the observational base of climate studies by providing accurate, long-term, consistent data including implementation of a strategy for integrated global observations.
- Enhancing the development of reconstructions of past climate periods.
- Improving observations of the spatial distribution of greenhouse gases and aerosols.

#### Modelling and process studies:

- Improving the understanding of the mechanisms and factors leading to changes in radiative forcing.
- Understanding and characterising the important unresolved processes and feedbacks, both physical and biogeochemical, in the climate system.
- Improving methods for quantifying uncertainties of climate projections

and scenarios, including long-term ensemble simulations using complex models.

- Improving the integrated hierarchy of global and regional climate models with a focus on the simulation of climate variability, regional climate changes, and extreme events.
- Linking more models of the physical climate and of the biogeochemical system more effectively, and then improving coupling with descriptions of human activities.

Cutting across these foci are crucial needs associated with strengthening international co-operation and co-ordination in order to better utilise scientific, computational, and observational resources. This should also promote the free exchange of data among scientists. A special need is to increase observational and research capacities in many regions, particularly in developing countries. Finally, in keeping with the goal of this assessment, there is a continuing imperative to communicate research advances in terms that are relevant to decision making.





## 3. The role of the ocean in global change

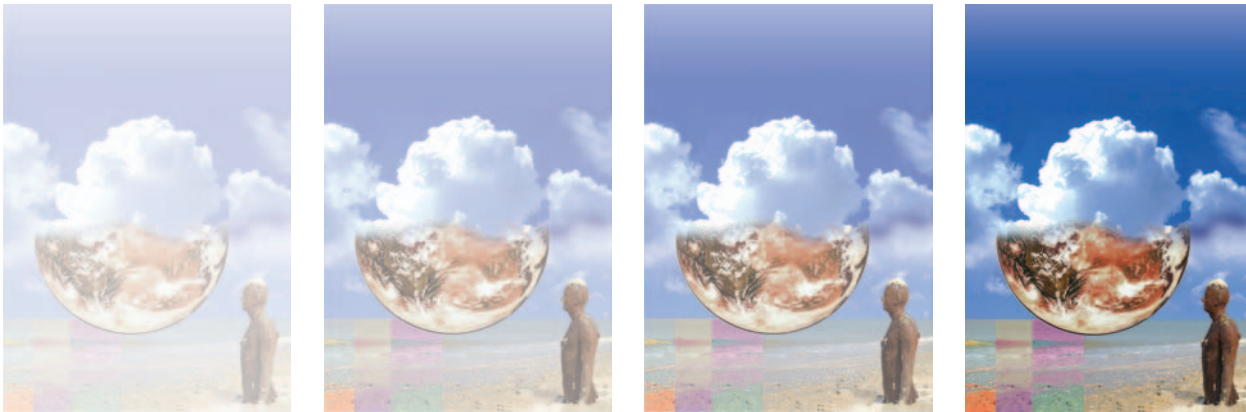

### 3.1 Introduction

In recent geological time, the ocean was a source of carbon dioxide gas ( $\text{CO}_2$ ) for the atmosphere.  $\text{CO}_2$  produced in the sea by organic and inorganic reactions involved in the global marine carbon cycle was quantitatively transferred to the atmosphere (Figure 3.1 a). This situation has been completely reversed today, owing to the ever-growing impact of human activities. According to the Intergovernmental Panel on Climate Change (IPCC) report Climate Change 1995, estimated anthropogenic emissions of carbon dioxide into the atmosphere were around  $7,100 \pm 1,100 \text{ Mt C/yr}$  in the mid-eighties, of which only  $3,300 \pm 200 \text{ Mt C/yr}$  remained in the atmosphere (Figure 3.1. b). The main sink of atmospheric  $\text{CO}_2$  was uptake by the oceans, estimated to reach  $2,000 \pm 800 \text{ Mt C/yr}$ . The missing  $\text{CO}_2$  ( $1,800 \pm 2,000 \text{ Mt C/yr}$ ) was attributed to various poorly quantified terrestrial sinks such as forest regrowth,  $\text{CO}_2$  and nitrogen fertilisation, and climatic effects.

The present-day transfer of  $\text{CO}_2$  from the atmosphere to the ocean has been estimated by a combination of modelling and measurements of carbon isotopes, but it is recognised that fluxes are affected by great uncertainties. For example, the existing global models are limited to the open ocean and do not include the complex continental margins, or more precisely the coastal zone, continental slope, and estuaries. These areas are, however, the most biologically active parts of the marine system. In addition, the organic and inorganic carbon cycles have been oversimplified, because of the complexity of the processes involved, and there is a lack of knowledge of the numerous parameters required for describing the functioning of marine ecosystems. In order to reduce these uncertainties, several BELSPO research projects have been devoted to better understanding the various processes involved in the marine carbon cycle. The projects were a response to recommendations of international scientific organisations such as the International

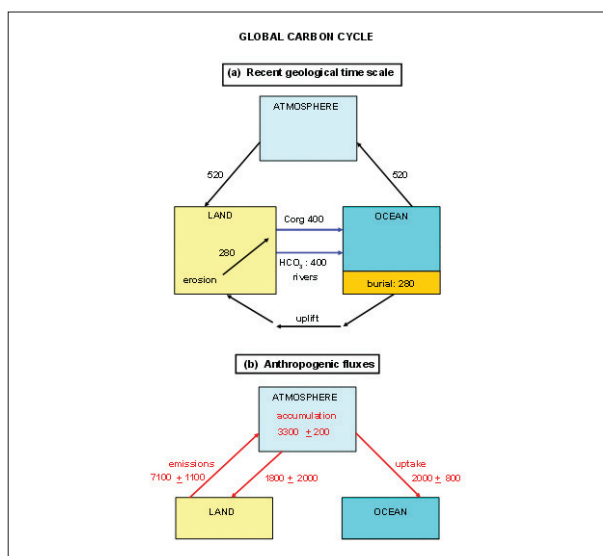

Figure 3.1 - The carbon cycle in recent geological time and its perturbation by human activities. All fluxes in Mt C/yr.

a) Before perturbation of the carbon cycle by human activities, the ocean acted as a source of  $\text{CO}_2$  for the atmosphere. Dissolved in rainwater, atmospheric  $\text{CO}_2$  constitutes the main agent for the chemical erosion of continental rocks. Bicarbonate ( $\text{HCO}_3^-$ ) resulting from the weathering of rocks is the principal dissolved component of river water. It is precipitated in the ocean as calcium carbonate ( $\text{CaCO}_3$ ) and accumulates in marine sediments. Rivers also carry to the sea organic matter eroded from land. In the ocean, precipitation of calcium carbonate and respiration of organic carbon (Corg) generate  $\text{CO}_2$ , which is transferred to the atmosphere. On a geological time scale, the carbon entrapped in marine sediments is uplifted by tectonic movements. (Adapted from Wollast and Mackenzie, 1989).

b) The anthropogenic  $\text{CO}_2$  flux from land to the atmosphere is one order of magnitude higher than the net natural flux and, as a consequence, the air-sea flux has been reversed. (IPCC SAR, 1995).

Geosphere-Biosphere Programme (IGBP), the Scientific Committee on Oceanic Research (SCOR), and the IPCC. In Belgium, major efforts have been deployed to understand and quantify the carbon cycle in the coastal zone corresponding to the Southern Bight of the North Sea, the wide continental shelf and margin of the Bay of Biscay, and several areas of the Southern Ocean. Attempts have also been

made to integrate and compare the results of the Belgian teams with the existing data on other marine systems, in order to evaluate carbon budgets on a global scale. The main results obtained by the Belgian teams are summarised here, after a brief description of the processes responsible for sequestration of anthropogenic  $\text{CO}_2$  by the ocean.

## 3.2 What are the physical, chemical, and biological processes responsible for $\text{CO}_2$ fluxes at the atmosphere-ocean<sup>2</sup> interface and within the ocean?

### 3.2.1 What are the carbon species present in the ocean?

Besides carbonate rocks, the ocean is the largest reservoir of inorganic carbon on the surface of the earth. It is mainly present as dissolved inorganic carbon, consisting predominantly of the bicarbonate ion ( $\text{HCO}_3^-$ ), with minor concentrations of free  $\text{CO}_2$  and carbonate ( $\text{CO}_3^{2-}$ ). These species are in chemical equilibrium and play an important role in regulating the pH (degree of acidity) of seawater. Inorganic carbon is also present as solid particles of calcium carbonate ( $\text{CaCO}_3$ ), which constitutes the skeleton of a wide variety of marine organisms, extending from microscopic algae to molluscs, echinoids, and sponges. Finally, organic carbon includes both living organisms and detrital matter, and is present at much lower concentrations as either dissolved or particulate compounds.

### 3.2.2 What is the process that drives the exchange of $\text{CO}_2$ between the ocean and the atmosphere?

$\text{CO}_2$  is a very soluble gas, and the dissolved  $\text{CO}_2$  in the surface water of the ocean is practically in equilibrium with gaseous  $\text{CO}_2$  in the atmosphere. When the concentration of

## The Role of the Ocean in Global Change

CO<sub>2</sub> in the atmosphere increases because of anthropogenic emissions, for example, dissolution of this gas occurs at the air-sea interface, maintaining conditions close to equilibrium in the surface layer. This reaction is perfectly reversible: an increase in dissolved CO<sub>2</sub> in the surface water may induce a flux of gaseous CO<sub>2</sub> to the atmosphere. The solubility of CO<sub>2</sub> in seawater is also temperature dependent (it decreases with increasing temperature), so that heating or cooling of surface water may be responsible for significant fluxes of CO<sub>2</sub> at the interface. About 90,000 Mt C/yr leave the ocean for the atmosphere when seawater is heated during its travel from high to low latitudes under the influence of wind-driven currents. A comparable flux returns to the ocean during the cooling of water as it travels to high latitudes.

The amount of CO<sub>2</sub> that can pass from the atmosphere to the ocean through the interface depends on the thickness of the water layer subjected to mixing, mainly through the action of the wind. The thickness of this mixed surface layer is limited to a few hundred metres and the residence time of CO<sub>2</sub> in it is only of the order of a few weeks to a few months. However, the flux of atmospheric CO<sub>2</sub> towards the sea can

be increased if CO<sub>2</sub> is removed from the mixed layer and transferred to the deep ocean. Three main processes can contribute to this transfer: the physical, biological, and carbonate pumps (Figure 3.2).

### 3.2.3 How is CO<sub>2</sub> transferred to the deep ocean by a physical process?

The existence of density differences caused by temperature and salinity changes generates large-scale currents that affect the full depth of the ocean. Cold dense waters, formed essentially in the northern North Atlantic with additional cooling in the Southern Ocean, sink through the oceanic depths and are responsible for the thermohaline circulation of the ocean (i.e. the movement of water masses due to density gradients linked to temperature or salinity differences). This sinking cold water is rich in CO<sub>2</sub> and provides a mechanism of carbon transfer from the surface water to the deep waters. This process, referred to as the physical pump, constitutes a carbon sink on a thousand-year time scale.

### 3.2.4 What is the influence of biological activity on vertical carbon fluxes?

Another way to transfer carbon from surface to deep water is through the so-called biological pump. In the upper layer of the ocean where sufficient light is available (the euphotic zone), CO<sub>2</sub> is consumed by algae to sustain photosynthesis and growth if the necessary nutrients are present. This process can be represented by the simplified equation:

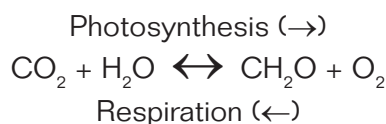

where CH<sub>2</sub>O is a simplified representation

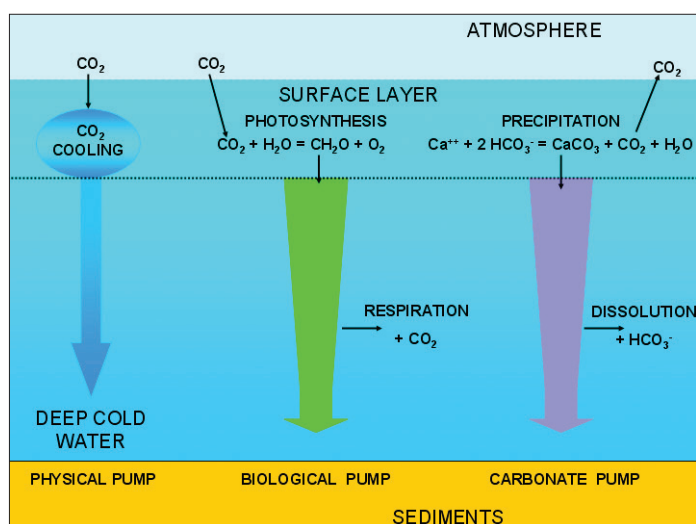

Figure 3.2 - Schematic representation of the major downward carbon fluxes within the ocean

of the synthesised organic algal material. Living or dead algae can be utilised as food by other organisms (zooplankton, fish, and bacteria). Organic carbon is thus partially remineralised by the process of respiration, regenerating  $\text{CO}_2$  and nutrients (e.g., nitrogen as ammonia and phosphorus as phosphate). As most grazing occurs in the surface water, the restored  $\text{CO}_2$  and nutrients can be used again in photosynthesis. This process is therefore called recycled production. The non-recycled fraction of organic matter sinks to deeper water as dead organisms or faecal pellets. This detrital organic matter is decomposed by bacteria in the intermediate and deep waters, where  $\text{CO}_2$  and nutrients are regenerated. Most of the remineralisation occurs between 0 and 1,000 m depth, and these intermediate water masses constitute a sink for carbon on a time scale of some decades. The nutrients that have been exported must be replaced in the surface water, either by vertical mixing of the water column or by river and atmospheric input. The production associated with these non-recycled nutrients is called new production and corresponds to the fraction of the algal production which is theoretically exportable. A small fraction of the organic matter produced in the surface water may reach the sediments by sinking. After deposition, it can be further degraded by organisms living on the sea bottom (benthic organisms). This phenomenon is important in the coastal zone because its limited depth favours sedimentation of detrital organic matter and fuels intense biological activity in the sediments. Finally, an even smaller fraction of the organic matter is buried and preserved in the marine sediments for millions of years.

### 3.2.5 What is the role of biogenic carbonate in the marine carbon cycle?

Not until recently has the carbonate pump been taken into consideration. Numerous marine

organisms build a calcium carbonate skeleton from dissolved bicarbonate ions according to the reaction:



This reaction is complex because it is a source of  $\text{CO}_2$  for the atmosphere and a source of particulate carbonate for the sediments. In the water column, sedimentation of the skeletons of marine plankton constitutes a mechanism of carbon transfer to deep waters. Yet under the influence of low temperature and high pressure, deep water may become undersaturated with respect to  $\text{CaCO}_3$  and dissolve this, regenerating bicarbonate and calcium according to the reverse of the above reaction. Nevertheless, a significant fraction of the  $\text{CaCO}_3$  produced by marine organisms is preserved in the marine sediments, where carbon is sequestered for millions of years.

## 3.3 How efficiently does the marine system sequester atmospheric $\text{CO}_2$ ?

### 3.3.1 Introduction

It is agreed that the ocean currently absorbs a significant fraction of the anthropogenic  $\text{CO}_2$ . However, major uncertainties still remain which prevent the reliable prediction of how the  $\text{CO}_2$  content of the atmosphere will evolve in the future and of the associated climate change.

An important source of uncertainty lies in the fact that carbon fluxes are calculated on the basis of global water circulation models that are restricted geographically to the open ocean and do not include the continental slope, coastal zone, and estuaries. This is largely due to the heterogeneity and complexity of these systems and to the lack of sufficient data for quantifying processes that affect the carbon cycle. Although the surface area of continental shelves

## The Role of the Ocean in Global Change

represents only 7% of the total surface area of the oceans, these shelves are characterised by very active physical, chemical, and biological processes that may strongly affect the oceanic carbon cycle and are responsible for significant fluxes of carbon on a global scale.

Another source of uncertainty is our poor knowledge of the processes controlling the carbon cycle in the Southern Ocean surrounding the Antarctic. Yet this area, which occupies only about 10% of the ocean surface, contributes some 30% of the global ocean CO<sub>2</sub> sink. Furthermore, the Southern Ocean is characterised by high concentrations of nutrients, contrasting with low concentrations of chlorophyll. It has recently been accepted that this phenomenon is due to the limitation of primary production because of the lack of iron, an essential micronutrient. Iron is supplied to the world oceans by atmospheric deposition of continental dust, coming mainly from areas such as the Sahara or the Gobi desert. The atmospheric deposition of iron is much more limited in the Southern Ocean than, for example, in the Atlantic or the Pacific. Major developments in the understanding and quantification of production are needed before it can be modelled.

Efforts of Belgian teams have been devoted essentially to the study of the European coastal ecosystem and various areas of the Southern Ocean. The main studies have been dedicated to understanding and quantifying the carbon cycle in the Southern Bight of the North Sea (IRSNB/KBIN, UGent-MARBIO, UA-MiTAC, ULB-GMMA, ULB-ESA, ULB-OCEAN, ULg-OCEANBIO, ULg-OCEANCHEM, ULg-ECOHYD, VUB-ANCH, VUB-ECOL) and over the large continental shelf of the gulf of Biscay (ULB-OCEAN, ULg-OCEANBIO, ULg-OCEANCHEM, ULg-LPAP, VUB-ANCH). The results are quite similar to those obtained for coastal zones of other regions, confirming

the high productivity of the shelf and its great capacity to fix carbon dioxide biologically. They also demonstrate the important role played by shelf sediments, characterised by high rates of deposition, particularly of organic matter and carbonates. The intense biological activity resulting from these high fluxes induces a significant recycling of nutrients, which are transferred back to the water column. In addition, the structure and complexity of the food web on the shelf differs markedly from that observed in the open ocean. The food web is very short in the coastal zone, which is favourable to high production of fish and other exploitable seafood: more than 80% of our marine resources are caught on the shelf. In the open ocean, algae are dominated by small-sized organisms, most of the organic matter produced is remineralised in the surface waters, and little is exported to the deep waters. Thanks to the data accumulated during coastal studies, Belgian scientists were able to better quantify the role of the shelf as compared to the open ocean in the global carbon cycle.

Belgian teams have also been very active in the Southern Ocean, where they have studied the factors controlling primary production by investigating the fate of living and detrital organic matter. Intensive measurements of CO<sub>2</sub> exchanges with the atmosphere have also been carried out (IRSNB/KBIN, KMCA/MRAC, UCL-ASTR, ULB-ESA, ULg-OCEANBIO, ULg-OCEANCHEM, ULg-ECOHYD, ULg-BOT, VUB-ECOL, VUB-ANCH). These efforts, including modelling of the CO<sub>2</sub> absorption capacity of the area, are essential to validating the frequently formulated hypothesis that the Southern Ocean may constitute the 'last oceanic CO<sub>2</sub> sink'.

### 3.3.2 How is CO<sub>2</sub> distributed in surface water and what are the fluxes at the air-sea interface?

So far, one of the best methods for assessing

global CO<sub>2</sub> fluxes between the atmosphere and the ocean has been to compile worldwide measurements of the CO<sub>2</sub> concentration in seawater and to compute fluxes with the help of empirical gas transfer coefficients. Although fluxes do depend on disequilibria between air and water concentrations and on physical mixing factors such as wind speed and current velocity, large gaps remain in our knowledge of CO<sub>2</sub> concentrations in the coastal zone, at the margins, and in the Southern Ocean. Furthermore, large uncertainties are attached to the values of the gas transfer coefficients used for the calculations.

The concentration of CO<sub>2</sub> in river water is usually well above the level of equilibrium with the atmosphere, so that freshwater systems generally constitute a source of CO<sub>2</sub> for the atmosphere. This over-saturation is due to the degradation of terrestrial organic matter caused by soil erosion. Anthropogenic activities have strongly enhanced this natural phenomenon owing to increased soil erosion and to the discharge of wastewater into the hydrographic system. Large fluxes of CO<sub>2</sub> to the atmosphere may be expected in estuaries and in the adjacent coastal zone because of the high organic load of rivers and the intense biological activity characterising these areas.

The distribution of dissolved CO<sub>2</sub> and its exchange with the atmosphere in estuaries have been studied extensively by ULg-OCEANCHEM by means of a unique technology allowing detailed surveys of the investigated areas. A substantial effort has focused on designing innovative CO<sub>2</sub> measurement devices that comply with the physical and chemical constraints of the coastal environment (Figure 3.3).



*Figure 3.3 - Floating Equilibrator System deployed in the Randers Fjord (Denmark). This device continuously monitors the CO<sub>2</sub> concentration of surface water, together with temperature, salinity, and meteorological parameters such as wind speed, air temperature, and solar irradiance. It is powered by batteries and a solar panel and includes an infrared spectrometer for CO<sub>2</sub> determinations. (ULg-OCEANCHEM).*

In parallel, attention has been paid to improving the evaluation of air-sea transfer coefficients with the help of the so-called bell technique. This technique allows direct measurement of gas exchanges across the sea surface. First measurements were carried out in the Scheldt estuary, where the concentration of CO<sub>2</sub> equals 25 times the level of equilibrium with the atmosphere, and where fluxes amounting to up to 790 t of carbon per day were observed. These measurements were extended by the ULg-OCEANCHEM team to ten other estuaries in the framework of the EU project BIOGEST (Biogas Transfer in Estuaries). According to these surveys, European estuaries may emit between 30 and 60 Mt C/yr into the atmosphere, representing 5 to 10% of the present anthropogenic CO<sub>2</sub> emissions for Western Europe (Figure 3.4).

## The Role of the Ocean in Global Change

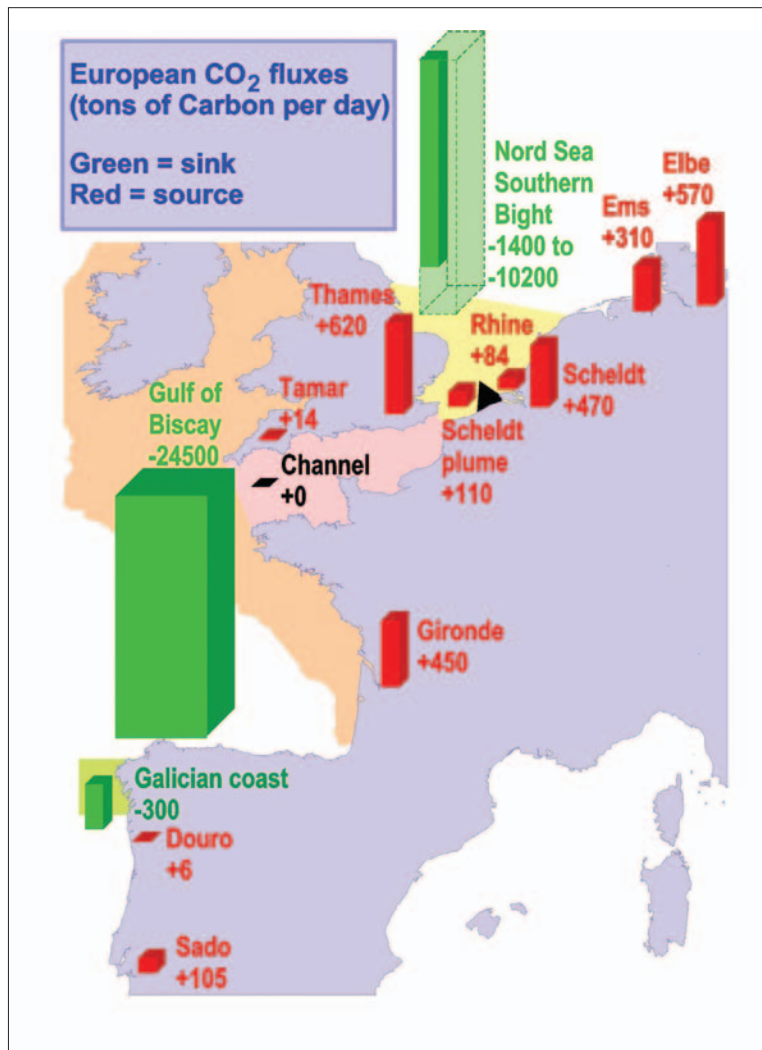

Figure 3.4 - CO<sub>2</sub> fluxes at the air-sea interface for various European estuaries and at the continental shelf. (ULg-OCEANCHEM).

The concentration of CO<sub>2</sub> in the coastal zone is controlled by various intricate processes responsible for fluctuations in the exchange with the atmosphere, both in direction and in intensity, on various time scales. Besides the discharge of river water rich in CO<sub>2</sub> and nutrients, the coastal zone also receives deep ocean water due to upwelling at the shelf edge. This physical process occurs under the influence of favourable wind events. In addition, enhanced vertical mixing of water masses is linked to interactions between the tides and the continental slope at the shelf break. This cold deep-ocean water is enriched in CO<sub>2</sub> and nutrients because of the

mineralisation of sinking organic matter. These phenomena are particularly well established along the continental margin (Figure 3.5), where they can be detected easily by remote sensing thanks to the low temperature of the deep-ocean water.

Belgian teams (ULB-GMMA, ULB-OCEAN, ULg-OCEANBIO, ULg-OCEANCHEM, ULg-LPAP, VUB-ANCH) were among the first to study these processes in the Bay of Biscay, and this preliminary work made it possible to launch a large European project called OMEX (Ocean Margin Exchange), coordinated by ULB-OCEAN. At the start of the upwelling or vertical mixing process, the surface water exhibits strong over-saturation in CO<sub>2</sub> with respect to the ambient air, and therefore constitutes a source of this gas for the atmosphere. This nutrient-rich water is favourable, however, to the growth of algae.

The consumption of CO<sub>2</sub> during photosynthesis rapidly reduces its concentration to below equilibrium with air. The surface water masses thus become a sink for atmospheric CO<sub>2</sub>. Measurements of the CO<sub>2</sub> distribution and of CO<sub>2</sub> fluxes at the margin and on the shelves of the Bay of Biscay, at the Iberian margin, and in the North Sea indicate that, on an annual basis, these areas constitute a significant overall sink for atmospheric CO<sub>2</sub> (Figure 3.4). Whether this is true on a global level remains a matter of debate owing to the lack of data. Little is known about the air-sea fluxes of CO<sub>2</sub> in tropical areas, but studies undertaken by Belgian research groups are underway in mangrove-dominated estuaries of South-East Asia and East Africa (ULg-OCEANCHEM, VUB-ANCH).

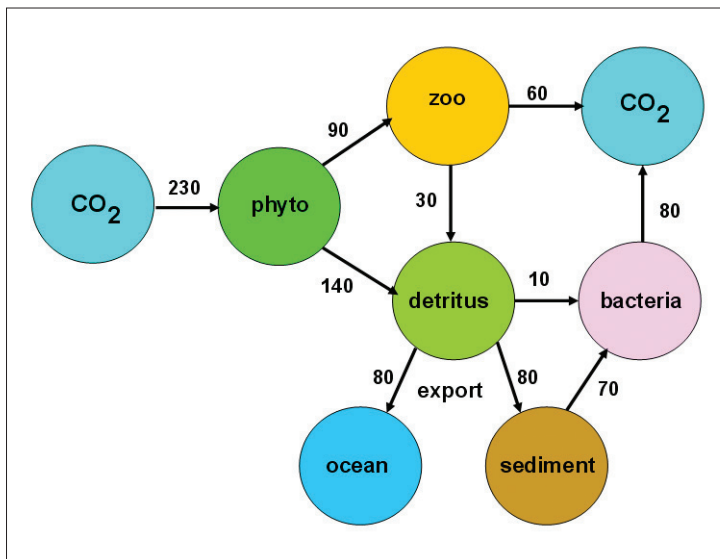

Figure 3.5 - Carbon fluxes in the coastal zone. All fluxes are given in  $g\ C/m^2/yr$ . (R. Wollast, 1998).

### 3.3.3 Is the biological pump an important process in the coastal zone and why?

As described above, photosynthesis is an efficient way to fix dissolved  $CO_2$  as particulate organic matter in the zone where sufficient light energy is available (the euphotic zone). This process constitutes a carbon sink only if the organic matter is transferred to the deeper water or buried in the marine sediments. A large fraction of organic carbon is in fact respired in the euphotic zone and thus does not contribute to the long-term withdrawal of  $CO_2$  from the surface water. Owing to the shallow depth of the coastal zone, detrital organic matter (dead organisms or faecal pellets) is rapidly transferred to the sediments, where it can easily be buried. The coastal zone is also the area where most of the detrital material carried by rivers from the continent is deposited. The resulting high rate of sediment accumulation is therefore most favourable to the burial of organic matter. However, the abundant flux of organic matter to the sediments sustains intense biological activity exerted by a large number of organisms (molluscs, fishes, worms, bacteria, etc). Here again, it is obvious that the continental shelf represents a complex area where knowledge

of numerous parameters is required in order to describe the carbon cycle satisfactorily.

The collaboration of several Belgian teams, whose research activities have been devoted to a detailed multidisciplinary budget of the carbon cycle in the Southern Bight of the North Sea, has led to significant progress in understanding the main processes and parameters that control the carbon cycle. Hydrodynamic (IRSNB / KBIN-MUMM), chemical (ULB-GMMA, ULB-OCEAN, ULg-OCEANCHEM, VUB-ANCH), and biological (UGent-MARBIOL, ULB-GMMA, ULB-ESA, ULB-OCEAN, ULg-OCEANBIO, VUB-ECOL) models, often coupled, were also developed in the course of this work, and have proved very useful in integrating data over long periods of time. The vertical distribution of organic matter, benthic organisms, oxidants, and metabolic compounds were determined in sediment cores so as to evaluate the benthic carbon cycle (UGent-MARBIOL, ULB-GMMA, ULB-OCEAN, VUB-ANCH). Modelling efforts allowed quantification of the rate of deposition, respiration, and preservation of organic carbon in the sediments (ULB-GMMA, ULB-OCEAN). The diagenetic models also gave valuable insights into the behaviour of nutrients and can be used to predict consequences of changing environmental conditions, for example during dredging operations.

To summarise briefly, it was shown that the mean primary productivity of the Southern Bight was around  $230\ g\ C/m^2/yr$ , i.e. about three times higher than in the open ocean. Of this amount, 31% was respired in the water column and 48% in the sediments. Thus, 21% of the production was either preserved in the sediments or exported to the northern part of the North Sea. In fact, these studies were similar to those carried out mainly in the coastal zone of the North Atlantic and North Pacific. They allowed a better evaluation of carbon fluxes in the water column of the coastal zone compared to that of the open ocean, for which



# The Role of the Ocean in Global Change

an ample set of data was already available. Fluxes per unit surface area in the coastal zone resulting from our estimations are detailed in Figure 3.5. A comparison of global fluxes in the coastal zone and in the open ocean is shown in Figure 3.6.

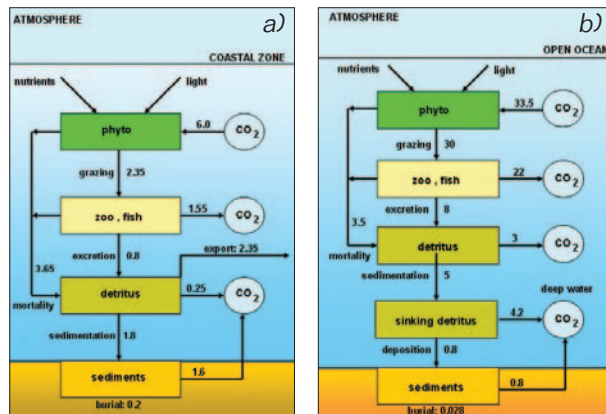

Figure 3.6 - Tentative global carbon cycle in the coastal zone. All fluxes are given in Gt C/yr. (ULB-OCEAN).

a) Organic matter produced in the water column and not mineralised during settling is either deposited in the sediments or exported to the open ocean. This organic matter is very reactive and induces intense biological activity in the upper layer of the sediments, leading to consumption of the deposited organic material. Finally, only a small fraction of the primary production is preserved in the sediments. The main export is the transfer of organic carbon from the shelf to the open ocean, where it can be remineralised in the water column. If this remineralisation occurs in the surface water, it will fertilise the slope area and contribute to the vertical flux of carbon there. The fraction of organic matter that can be transferred to the intermediate water at the shelf break represents a sink on a time scale of a few years. Finally, a small fraction may also reach the sediments of the slope and ultimately be buried and preserved. Fluxes of organic carbon exported from the shelf and the fate of this carbon remain poorly known.

b) Compared to the coastal zone, a large fraction of the organic matter produced in the euphotic zone is consumed by zooplankton and other organisms. Only a small fraction is transferred to the intermediate and deep water and almost no organic matter reaches the sediments. The recycled production is of the order of 85% of the total production and only 15% is transferred to the intermediate and deep water.

## 3.3.4 What is the contribution of the biological pump in the deep ocean and at the margins?

The Belgian teams used various approaches to evaluate vertical fluxes of organic carbon in the deep sea due to the biological pump. The problem is, in theory, less complex in the deep sea where the amount of material collected in sediment traps deployed at various depths can be used, in theory, to evaluate the sedimentation rate of organic carbon and to deduce, by difference, the rate of respiration of the organic matter during settling. The problem is complicated by the fact that the efficiency with which sediment traps collect settling particles is far from ideal. This may lead to underestimating vertical fluxes of organic carbon. The abundance of a radionuclide (thorium-234) produced naturally in the water column and scavenged by particles generated during photosynthesis has been used by VUB-ANCH and ULB-OCEAN to correct for this lack of efficiency. VUB-ANCH was among the first to use the vertical distribution of barite, a mineral formed during breakdown of organic matter, to evaluate mineralisation in intermediate and deep waters. The interest of the barite proxy is well illustrated in the case of the Southern Ocean (Figure 3.7), where prolonged mooring of sediment traps is questionable. The figure gives a synoptic view of the carbon flux associated with subsurface mineralisation of organic carbon exported via the biological pump, based on more than 10 years of field and modelling work in the Southern Ocean, notably in the framework of the BELCANTO I (Belgian research on Carbon uptake in the Antarctic Ocean) project (VUB-ANCH, ULB-ESA, ULg-OCEANCHEM, UCL-ASTR, KMMA / MRAC). It shows that the highest rates of subsurface carbon mineralisation are closely associated with the occurrence of the Polar Front in the Atlantic, Indian, and Australian sectors of the Southern Ocean. Lowest mineralisation rates are observed close

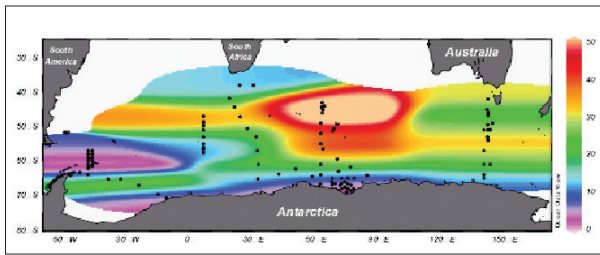

Figure 3.7 - Synoptic view of the mineralisation of organic carbon exported to the deep sea via the biological pump in the Southern Ocean. The data were calculated using the barite proxy of organic carbon mineralisation along vertical profiles at the stations indicated on the map. This flux reflects the importance of the biological pump in the area. The  $\text{CO}_2$  released by bacterial activity in the deep sea remains sequestered on a time scale ranging from decades to a few centuries. (KMMA / MRAC, VUB-ECOL).

to the Antarctic continent and in the Weddell Sea. In the Indian sector, organic carbon mineralisation is particularly high in the intermediate waters surrounding the Kerguelen archipelago (up to  $15 \text{ g C/m}^2/\text{yr}$  for a growth season of 6 months). The results confirm that, on an annual basis, the area is a net  $\text{CO}_2$  sink. Supporting this, results obtained with the complex biogeochemical model SWAMCO, Seawater Microbial Community Model (ULB-ESA, UCL-ASTR) predict a strong increase in atmospheric  $\text{CO}_2$  uptake by the Southern Ocean at a latitude of  $50^\circ\text{S}$ . The result computed for 2000 ( $12 \text{ g C/m}^2/\text{yr}$ ) is a good match with measurements of the air-sea  $\text{CO}_2$  flux carried out by ULg-OCEANCHEM (Figure 3.8) in the Indian sector of the Southern Ocean, which represents a sink of about  $250 \text{ Mt C/yr}$ . This  $\text{CO}_2$  remains sequestered in the deep sea on a time scale ranging from decades to a few centuries.

The vertical distribution of organic carbon concentration in the water column was also determined in the Bay of Biscay by collecting

suspended matter with stand-alone pumps immersed to various depths (ULB-OCEAN, VUB-ANCH, KMMA / MRAC). These distributions were combined with flux measurements using sediment traps, performed during the OMEX project. They allowed a better evaluation of the mineralisation rate of organic carbon in the water column and sediments. The main conclusion of this study is that productivity at the European shelf break is moderately high ( $200 \text{ g C/m}^2/\text{yr}$ , of which about 50% is new production). However,  $50 \text{ g C/m}^2/\text{yr}$  are respired in the shallow water (between 100 and 200 m) and  $20 \text{ g C/m}^2/\text{yr}$  are deposited and almost completely remineralised in the sediments. The sediment traps moored on the slope and adjacent abyssal plain indicate that  $30 \text{ g C/m}^2/\text{yr}$  are exported from the shelf to the deep ocean. This represents an export flux of 1,500 tons of organic carbon per kilometre of shelf per year, but little of this is preserved in the sediments. The northern Biscay margin thus does not act as a zone of accumulation of organic carbon in the sediments. However, approximately 15% of the primary production is exported to the intermediate and deep waters where it is temporarily sequestered from decades to centuries.

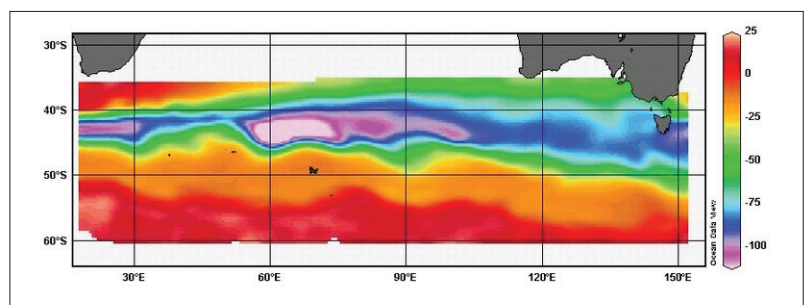

Figure 3.8 - Spring and summer mean air-sea fluxes of  $\text{CO}_2$  for the Indian sector of the Southern Ocean (between  $35$  and  $60^\circ\text{S}$ ). The fluxes are in  $\text{mg carbon/m}^2/\text{day}$ . The map has been reconstructed from the results of five campaigns of  $\text{CO}_2$  measurement and extrapolated using remote sensing of sea surface temperature and wind speed. (ULg-OCEANCHEM).

## The Role of the Ocean in Global Change

### 3.3.5 What are the CO<sub>2</sub> fluxes linked to the carbonate pump?

Most research on the carbon cycle in relation to climatic change has focused so far on the organic carbon cycle. Only little attention has been paid to the inorganic carbon cycle, although the corresponding fluxes are comparable to those of organic species.

Carbonate rocks are amongst the most reactive deposits exposed to erosion on land. Their dissolution by rainwater saturated with atmospheric CO<sub>2</sub> constitutes a major contribution to the composition of river water:

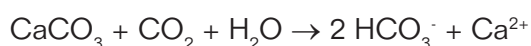

In order to maintain a steady-state composition of the ocean, this input must be compensated by the removal of these elements from the marine system. This process is the biological precipitation of calcium carbonate, which is the reverse of the dissolution reaction shown above. The annual river flux of bicarbonate is well known and equivalent to 390 Mt C/yr. If the steady-state condition is assumed, one-half of this carbon will be precipitated as calcite and the other half will be released as CO<sub>2</sub> into the atmosphere. The problem is complicated, however, by the fact that the deeper parts of the ocean and most of the marine sediments are undersaturated in calcium carbonate with respect to its solubility. Some of the carbonate minerals precipitated in the surface water may thus be dissolved in deep water or after deposition in the sediments. The fluxes associated with these processes are poorly quantified and may introduce large errors in the marine carbon budget. Various aspects of this problem have been treated in detail by ULB-OCEAN which has examined the dissolution and precipitation kinetics of carbonate minerals and the production and distribution of CaCO<sub>3</sub> in the water column, and has focused on elaborating

the global carbonate budget.

Coccolithophorids are the most abundant algae producing a calcite skeleton. They are the dominant species present in the Bay of Biscay. During the OMEX project, production rates of CaCO<sub>3</sub> equal to 100 g CaCO<sub>3</sub>/m<sup>2</sup>/yr were found. However, the concentration of this compound in the water column decreases rapidly with depth, even in shallow waters oversaturated with CaCO<sub>3</sub> with respect to its solubility (Figure 3.9). This phenomenon is confirmed by the reduced fluxes of this mineral in shallow sediment traps (about or less than 20 g CaCO<sub>3</sub>/m<sup>2</sup>/yr). The similarity of the vertical profiles of CaCO<sub>3</sub> and organic matter suggests that the occurrence of carbonate dissolution is associated with the respiration of organic matter, probably within faecal pellets. A similar phenomenon has been demonstrated in calcareous sands, which are abundant in coastal areas and shallow seas. Under well-oxygenated (oxic) conditions, the respiration of organic matter produces carbonic acid, which dissolves deposited carbonates, reducing strongly their preservation in the sedimentary column.

On the shelves, coral reefs are the largest calcium carbonate producers (about 100 Mt of carbon fixed annually on a global scale). They are associated with algae that display high rates

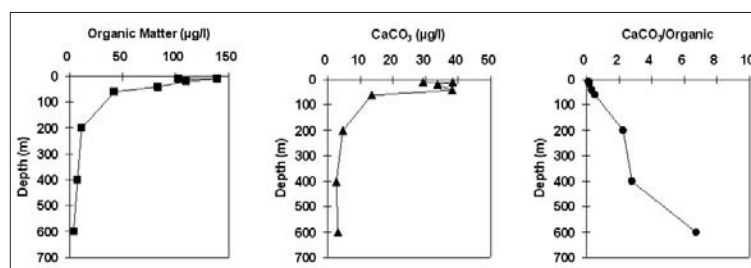

Figure 3.9 - Vertical profile of the distribution of particulate organic matter and CaCO<sub>3</sub> in the Bay of Biscay. Both C component concentrations decrease very rapidly with depth, but the evolution of the ratio of CaCO<sub>3</sub> to organic matter shows that calcite is better preserved in the water column. (R. Wollast and L. Chou, 1998).

of organic carbon metabolism, and it is often difficult to estimate the net  $\text{CO}_2$  budget. This task was performed by ULg-OCEANCHEM during several international campaigns. They showed that coral reefs are, in general, a source of  $\text{CO}_2$  for the atmosphere, which will increase with increasing atmospheric  $\text{CO}_2$ . Reefs may, however, become a sink of  $\text{CO}_2$  in eutrophicated areas.

A tentative global budget of carbonates is represented in Figure 3.10. It indicates that the precipitation of carbonates in surface waters and its dissolution in deeper waters and sediments constitutes an efficient carbon pump, responsible for vertical fluxes similar to those of the biological pump. It is also interesting to note that, according to this budget, the ocean system is presently not in a steady state. There is an excess of precipitated carbonate with respect to the river input. However, this does not represent an additional sink for  $\text{CO}_2$ , since the precipitation

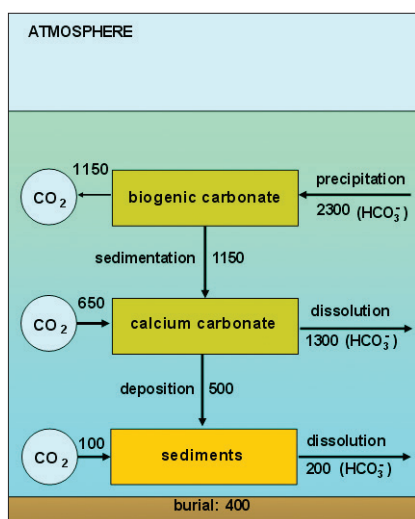

Figure 3.10 - Tentative global cycle of calcium carbonate in the marine system (all fluxes are given in Mt C/yr). The production of calcium carbonate in the euphotic zone and its dissolution in deeper water result in a downward transfer of bicarbonate ( $\text{HCO}_3^-$ ) and an upward transfer of  $\text{CO}_2$ . In order to maintain a steady state, the annual burial of 400 Mt C as  $\text{CaCO}_3$  must be compensated by an equal release of C as  $\text{CO}_2$  into the atmosphere. (R. Wollast, ULB-OCEAN).

of one unit of carbonate generates one unit of  $\text{CO}_2$ . Many unknowns and uncertainties remain in the oceanic carbonate cycle and efforts are still underway in the Belgian scientific community to improve its quantification.

### 3.3.6 How good are global carbon cycle models at simulating the historical uptake of anthropogenic $\text{CO}_2$ by the ocean?

As already stated, the uptake by the ocean of anthropogenic carbon in the 1980s was estimated to be about 2,000 Mt C/yr. This net flux is superimposed on gross natural fluxes to and from the ocean, these being one to two orders of magnitude larger. Models may not only help to distinguish between the two signals but also provide the only means of forecasting the evolution of the global carbon cycle. The ocean carbon cycle model LOCH, developed by ULg-LPAP, is a three-dimensional (3-D) reaction-transport model. It computes the evolution of total dissolved inorganic carbon, total alkalinity, phosphate, oxygen, organic matter, and silica, together with the isotopes 13 and 14 for all carbon species. Atmospheric values of  $\text{CO}_2$ , oxygen, and carbon isotopes are also among the prognostic variables. The main processes considered are air-sea gas exchanges, the evolution of plankton biomass leading to new production, remineralisation and sequestration of organic matter, calcium carbonate or silicate shell formation, and the subsequent dissolution or sedimentation of shells. The rate of oceanic  $\text{CO}_2$  uptake is primarily driven by the renewal time of surface water masses. Different hydrodynamic models provide different mixing rates of surface and deep waters. In addition to the development of the ocean carbon cycle model, research at ULg-LPAP has been devoted to identifying processes leading to different model behaviours. To this end, LOCH was adapted to be driven by different existing 'Ocean

## The Role of the Ocean in Global Change

General Circulation Models' (OGCMs). Figure 3.11 compares, for example, the observed evolution of atmospheric CO<sub>2</sub> with that resulting from the calculations if no uptake by the ocean is assumed. The changes in atmospheric CO<sub>2</sub> due to anthropogenic fluxes, computed for two circulation models, are also reported. It can be seen that the predicted atmospheric values start to diverge from 1950 onwards, indicating the presence of an unaccounted CO<sub>2</sub> sink. The different behaviour in models is better illustrated

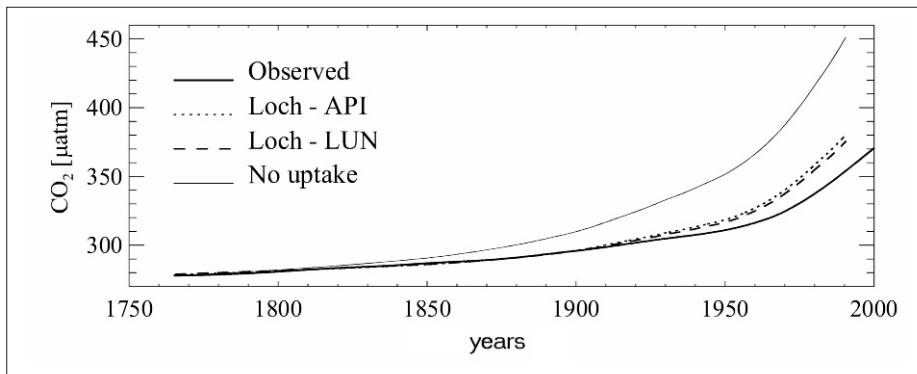

Figure 3.11 - Evolution of the observed atmospheric CO<sub>2</sub> between 1765 and 2000 as compared with (1) the evolution that would have resulted in the absence of uptake by the ocean and (2) computed changes in atmospheric CO<sub>2</sub> due to anthropogenic fluxes, using the ocean carbon cycle model LOCH coupled with the API or LUN ocean circulation model. (ULg-LPAP).

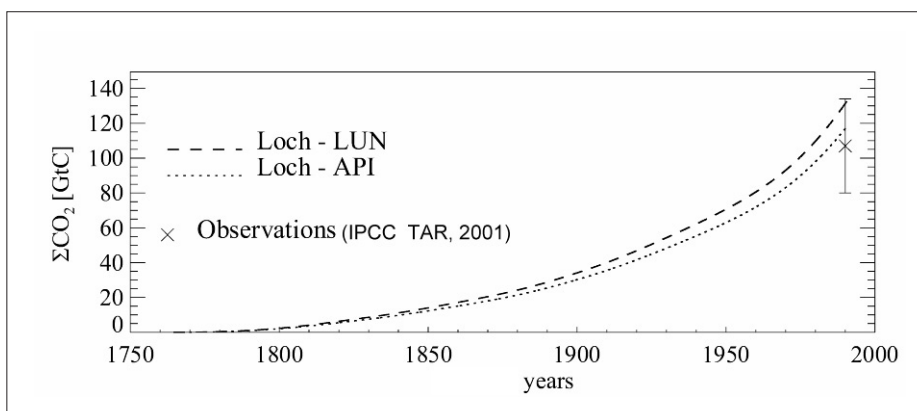

Figure 3.12 - Amount of carbon stored in the ocean since 1765. The ocean inventories correspond to the model results when the observed atmospheric CO<sub>2</sub> concentrations are imposed. (ULg-LPAP).

by the carbon inventory, which is the amount of carbon stored in the ocean since 1765 (Figure 3.12).

### 3.4 What are the interactions between nutrients and the carbon cycle in the aquatic system?

#### 3.4.1 Introduction

Besides light, the main factor controlling photosynthesis, primary production is

often limited by the availability of nutrients. In aquatic systems, nitrogen and phosphorus are most often the limiting nutrients. However, diatoms which are large phytoplankton cells inducing efficient

food webs, also require dissolved silicium (Si) to produce their skeletons, and the exhaustion of this element in the system prevents their further growth. Finally, trace elements such as iron (Fe) and zinc (Zn) are essential micronutrients, and their very low concentration, observed mainly in

marine systems, may constitute a limiting factor for primary production.

Domestic, agricultural, and industrial activities are responsible for the emission of large quantities of nitrogen and phosphorus into the

aquatic environment. This fertilisation is critical in surface waters of highly populated areas, where excess production of phytoplankton

commonly occurs. This phenomenon, called eutrophication, is associated with adverse effects such as decreased biodiversity, food web modification and destabilisation, and anoxia (i.e. the absence of oxygen). Such effects have often been observed and studied in Belgian rivers and in the North Sea. Silica, on the contrary, has been less affected by human activities. This has led to an unbalanced abundance of nutrients in the aquatic environment, which in turn is responsible for shifts in phytoplankton species. The control of primary production by trace elements in marine systems has been demonstrated more recently. It is especially relevant for iron in the Southern Ocean where iron depletion limits photosynthesis. The case of each of these nutrients is discussed in the following paragraphs.

### 3.4.2 Nitrogen

Nitrogen in the form of  $\text{NO}_3^-$  (nitrate) or  $\text{NH}_4^+$  (ammonium) is considered to be the limiting nutrient in most marine systems. It has therefore received much more attention than other nutrients. The nitrogen cycle in aquatic environments is quite complex. It is briefly schematised in Figure 3.13. The dissolved nitrogen gas  $\text{N}_2$ , which is the most abundant N-species in water, is very stable and not readily assimilated by phytoplankton cells. It represents only a minor source of nitrogen in strongly N-depleted areas such as the tropical parts of the ocean. Besides  $\text{N}_2$ , the second most abundant N-species in water is nitrate ( $\text{NO}_3^-$ ) which can be incorporated by living cells in order to build new biomass. When organic matter is mineralised, nitrogen is released as ammonium ( $\text{NH}_4^+$ ), which is very reactive and preferentially used by phytoplankton for energetic reasons. Thus, the recycled production is sustained by  $\text{NH}_4^+$  whereas the new production is based on the use of  $\text{NO}_3^-$ . Measuring the uptake of isotopically labelled  $\text{NH}_4^+$  and  $\text{NO}_3^-$  is a

classical way to distinguish between new and recycled production. This method has been used intensively by VUB-ANCH and extended to the use of labelled urea, representative of organic nitrogen. Ammonia is also converted to nitrate by bacteria (nitrification) as a source of energy. Finally, in the absence of oxygen, bacteria may use nitrate as an oxidant and reduce it to  $\text{N}_2$ .

This cycle suffers from numerous perturbations related to anthropogenic activities. The hydrographic system collects a large fraction of the nitrate used as fertiliser, which is easily washed out from soils. Ammonia is released mainly from manure and is abundant in rainwater

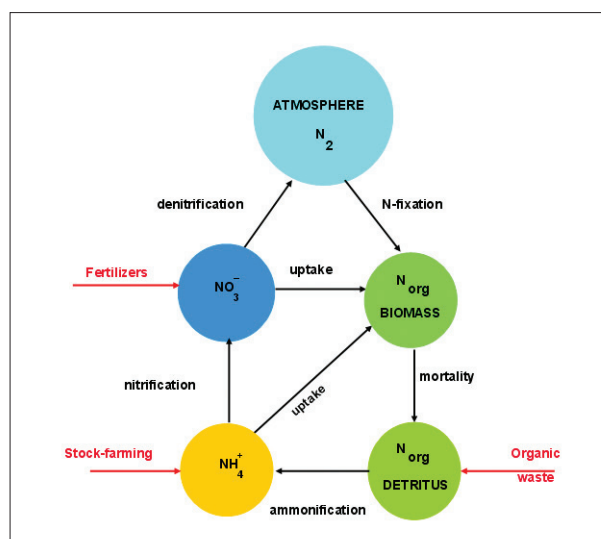

Figure 3.13 - Schematic representation of the nitrogen cycle in aquatic environments and its perturbations represented by red arrows.

in areas of intensive stock farming. Finally, domestic and some industrial wastewaters are rich in organic nitrogen and ammonium. Anthropogenic activities also influence nitrogen fluxes indirectly. Oxygen depletion in aquatic systems, due to an excessive organic load, favours the denitrification process, through which nitrate is consumed, reduced, and transferred to the atmosphere as  $\text{N}_2$ .

The nitrogen cycle in aquatic systems has been intensively studied by Belgian teams (UA-MiTAC, ULB-GMMA, ULB-ESA, ULB-OCEAN,

## The Role of the Ocean in Global Change

VUB-ANCH). Concentrations of nitrogen species in European rivers are presently one to two orders of magnitude above their pristine values. They are thus seriously disturbed, notably by eutrophication. Estimation of nitrogen inputs from various sources for some major European tributaries to the North Sea are compared in Figure 3.14. With the exception of the Scheldt, which is even more heavily

polluted, the total N-input (expressed per unit surface area of the river catchments) is similar for all European rivers and close to 10 kg N/km<sup>2</sup>/day. This value is to be compared with 0.1 kg N/km<sup>2</sup>/day for pristine rivers. It is interesting to note that the contributions of agricultural, industrial, and domestic activities are comparable. Furthermore, the observed nitrogen outputs into the North Sea, which are

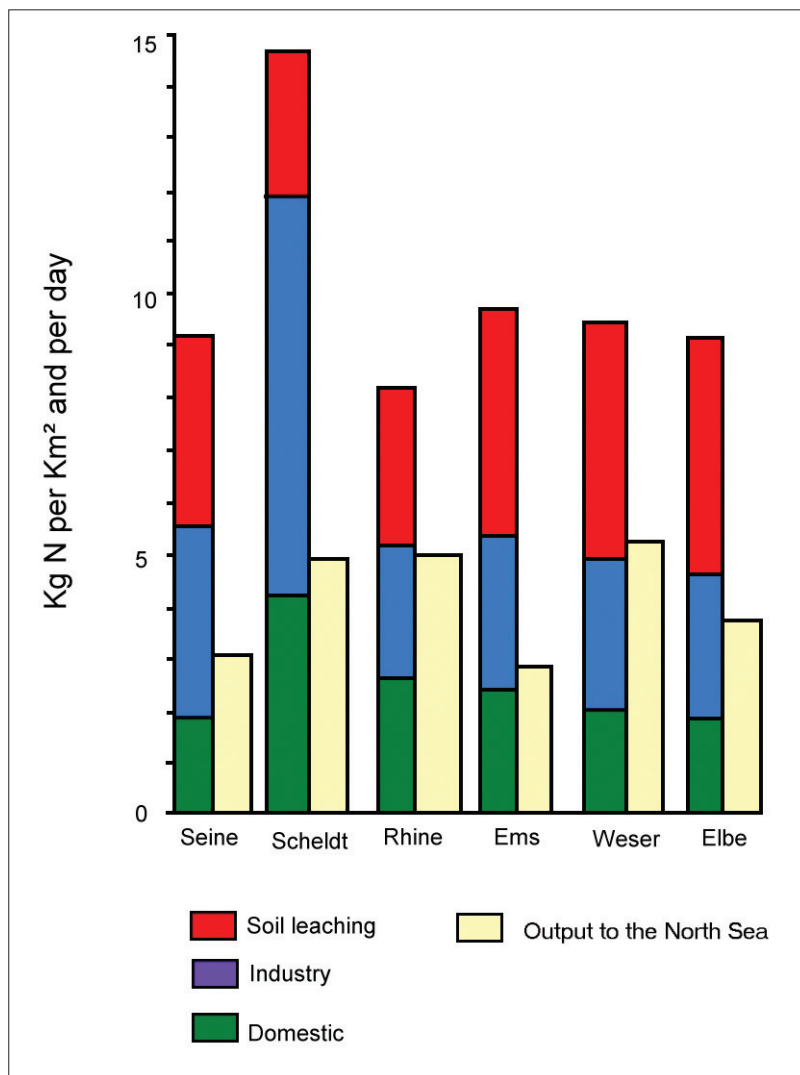

Figure 3.14 - Estimate of nitrogen inputs from agricultural (soil leaching), industrial, and domestic activities per unit area of the hydrographic basin for the main rivers discharging into the North Sea. The output of nitrogen at the mouth of each river is also indicated for comparison with the total input, based on data from the period 1975-1985). (G. Billen, ULB-GMMA).

also reported in Figure 3.14, represent less than one-half of the total N input into all the river systems considered. This means that more than one-half of the nitrogen discharged into European rivers is eliminated before reaching the sea. Two processes might explain this N loss. The most important is denitrification, which may occur either in anaerobic river stretches or more frequently in anoxic sediments, often present in polluted streams. Some nitrogen is also removed from the water column by sedimentation of organic matter, but this process represents only a small amount compared to denitrification.

According to a study by ULB-GMMA, the development of conventional wastewater treatment plants may be responsible for a decreased denitrification rate in the river system, due to a decrease in the organic load and thus in the occurrence of anoxic conditions in the water column or sediments. New policies of hydraulic management of rural streams, leading to an increased flow velocity and a better re-aeration of the water column, also tend to prevent the

building up of anoxic sediments and to reduce the denitrification rate. Thus, increased investments in setting up conventional treatment plants and the hydraulic management of water courses might paradoxically have led to an increased nitrogen supply to the sea, because of the reduced capacity of the river system to sustain denitrification. In a later study, ULB-ESA also showed that the application of tertiary treatment (i.e. the elimination of nitrogen and phosphorus at wastewater treatment plants) would not be sufficient to significantly reduce eutrophication in the coastal zone of the Southern Bight of the North Sea, if the problem of diffuse agricultural sources is not also considered.

The identification and quantification of processes affecting the nitrogen cycle in sediments is another aspect intensively studied by Belgian teams (ULB-GMMA, ULB-OCEAN). Prognostic models were developed and used to describe the recycling of organic nitrogen and to predict fluxes of nitrogen species ( $\text{NO}_3^-$ ,  $\text{NH}_4^+$ ,  $\text{N}_2$ ) from sediments to the overlying water (Figure 3.15). It was demonstrated that

the rapid recycling of nitrogen in the sediments is among the major causes of the high fertility of the continental shelf.

It has long been thought that river input was a major source of nutrients accounting for the high productivities observed in the coastal zone. The upwelling of deep ocean water by favourable but sporadic wind events along the coast was also known to import large amounts of nutrients into the euphotic zone and thus to be responsible for the existence of highly productive coastal areas. These upwelling areas are, however, in limited number, and other physical processes capable of transferring deep water to the shelf at continental margins were poorly quantified. Remote sensing images (Figure 3.16) demonstrate clearly the occurrence of cold, nutrient-rich water along the margin and on the adjacent shelf. This phenomenon is particularly well established from spring to fall along the European margin in the Bay of Biscay. The vertical mixing of water masses at the shelf break is related to the existence of internal waves which are amplified when they

reach the continental slope. The effects of this transfer of nutrient-rich ocean water was investigated first by Belgian teams (ULB-OCEAN, ULg-OCEANCHEM, VUB-ANCH) and later in collaboration with European teams in the framework of the EU project OMEX. It was found that the annual productivity at the margin in the Bay of Biscay, related to the vertical mixing of intermediate waters, reaches  $200 \text{ g C/m}^2/\text{yr}$  at the shelf break in an area far from any river input. This value is twice that measured at adjacent deep-water stations. Moreover, some of the deep water travels on the shelf

and enters the Channel, where it represents by far the largest source of nutrients. Because only a limited amount of nitrogen is denitrified or accumulated in the sediments of the Channel, a large fraction of this nitrogen source feeds the

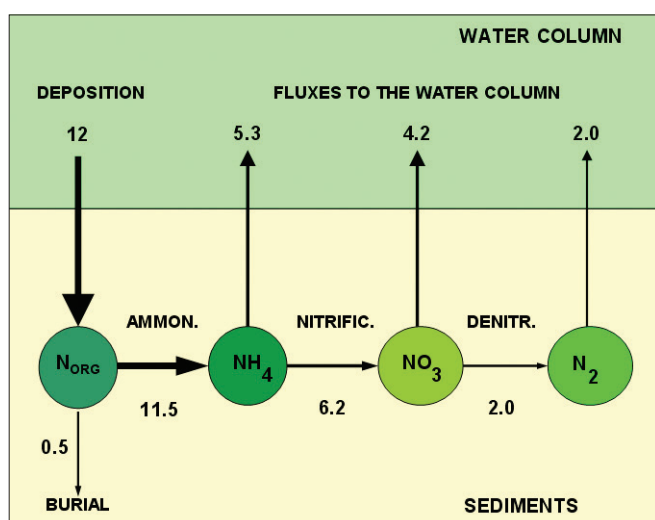

Figure 3.15 - Fluxes of the various N-species from coastal sediments to the water column, resulting from the respiration of deposited organic matter and from processes affecting the N cycle (see Figure 3.13) (ULB-GMMA, ULB-OCEAN). Mean global estimate in  $\text{g N/m}^2/\text{year}$ . (Wollast, 1998).



## The Role of the Ocean in Global Change

Southern Bight of the North Sea.

A tentative budget of the coastal zone, based mainly on the results of Belgian research efforts but also including data from other studies, is presented in Figure 3.17. One-third of the nitrogen required to sustain

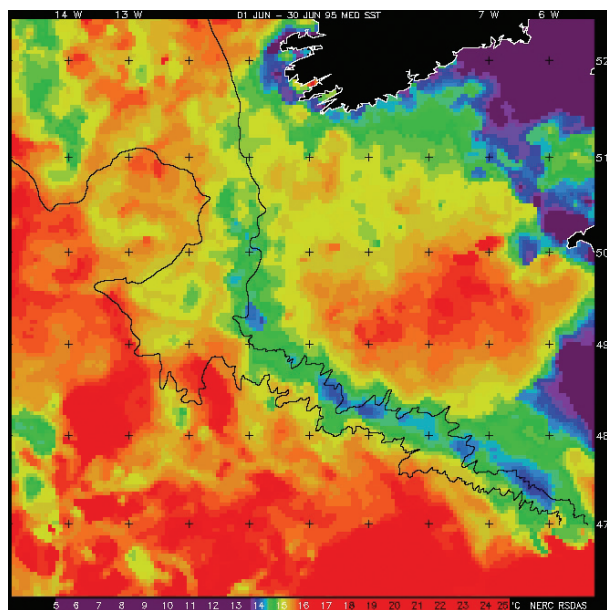

Figure 3.16 - Sea surface temperature distribution (24 June 1995) along the margin of the Bay of Biscay (Northeast Atlantic Ocean). Note the close coincidence of the cold water layer with the 200-m isobath and the existence of tidal mixing fronts on the shelf (Advanced Very High Resolution Radiometer (AVHRR) data were received at NERC Dundee University Station and processed by the Remote Sensing Group at the Plymouth Marine Laboratory).

productivity is recycled within the water column. This means that two-thirds must be provided by other sources. Actually, a large fraction of the nitrate-based production is sustained by N recycled through the sediments, so that effective new production is in fact only about 40% of the total nitrate-sustained production. Most of the nitrogen necessary to sustain new production (80%) comes from the deep ocean water, only 15% is provided by rivers, and 5% by the atmosphere. Thus, two major factors may explain the fertility of the coastal zone: efficient recycling of nutrients in the sediments and the

input of deep ocean water. River input represents only a limited contribution and its effect is usually limited to the estuarine plume. It is also interesting to note that the import of nitrogen from deep water as  $\text{NO}_3^-$  is compensated by the export of organic N from the shelf to the open ocean. This N budget represents one of the most valuable contributions of Belgian teams to understanding the origin of the fertility of the coastal zone.

### 3.4.3 Phosphorus

Phosphate is another essential nutrient that may control the production of phytoplankton. It plays an essential role in energy transfer within cells. It is present in water mainly as dissolved

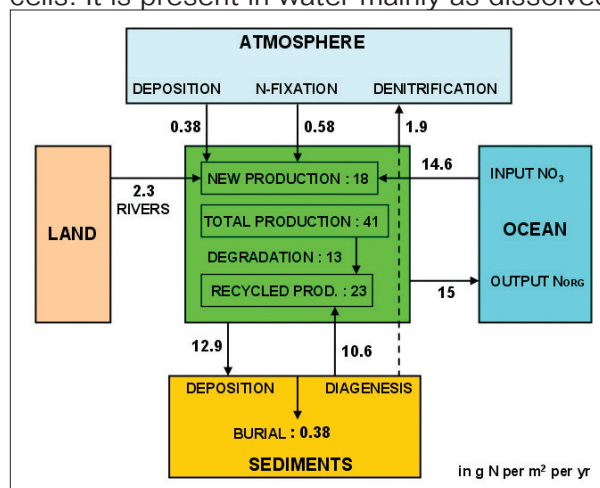

Figure 3.17 - Mean global fluxes of nitrogen in the coastal zone summarising various measurements and estimations performed by Belgian teams (UAMiTAC, ULB-GMMA, ULB-ESA, ULB-OCEAN, VUB-ANCH).

phosphate ( $\text{PO}_4^{3-}$ ) at very low concentration. Phosphate is consumed not only by phytoplankton during photosynthesis, but also by bacteria, which require this element in large amount to increase their biomass (Figure 3.18). During remineralisation of detrital organic matter, organic phosphorus ( $\text{P}_{\text{org}}$ ) is transformed and released as phosphate. Deposited organic phosphorus is also predominantly remineralised to phosphate, and dissolved phosphate is

partially transferred back to the water column by diffusion.  $\text{PO}_4^{3-}$  may also react with other dissolved or particulate constituents in the sediments to produce phosphate minerals, which are buried and incorporated into the geological cycle. In order to maintain a constant composition of the ocean, the river input of dissolved phosphate must compensate for the removal of phosphate minerals by burial in the sediments. Major climatic changes in the geological past may have modified the phosphate content of the sea because of the effect of climate on primary production and burial of phosphate minerals.

In undisturbed marine systems, the phosphorus concentration is usually sufficient and this element is never completely depleted in the water column. Figure 3.19 reports the evolution of the concentration of nitrogen

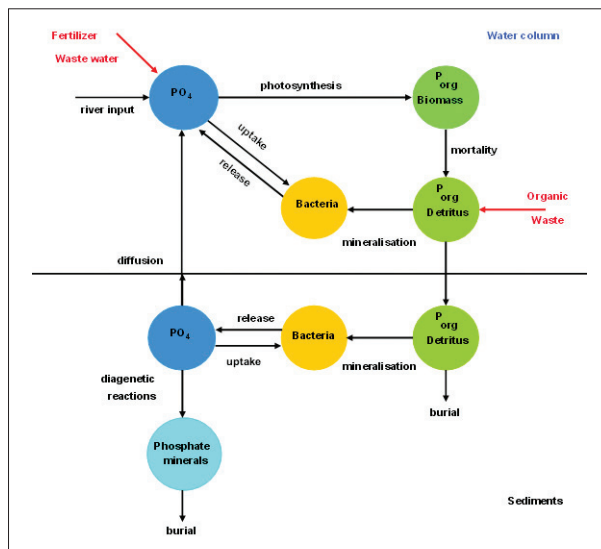

Figure 3.18 – Schematic representation of the phosphorus cycle in aquatic systems. The main anthropogenic perturbations are represented by red arrows.

and phosphorus in water samples collected at various depths in the Bay of Biscay. High concentrations of both elements correspond to deep water masses. It can be seen in this figure that nitrate is completely exhausted in surface

waters but that some phosphate still remains, indicating that nitrogen is the limiting element in this area. Figure 3.19 shows also that the ratio of dissolved nitrogen to phosphorus is remarkably constant despite the biological processes that add and remove these two elements at a rate much faster than the rate of mixing of the ocean. The straight line reflects the constant N:P ratio in the organic matter produced by phytoplankton, similar to the N:P ratio in seawater.

Yet the input of anthropogenic phosphorus into aquatic systems, mainly provided by fertilisers and domestic wastewater, is proportionally lower than that of nitrogen. The discharge of anthropogenic phosphorus into

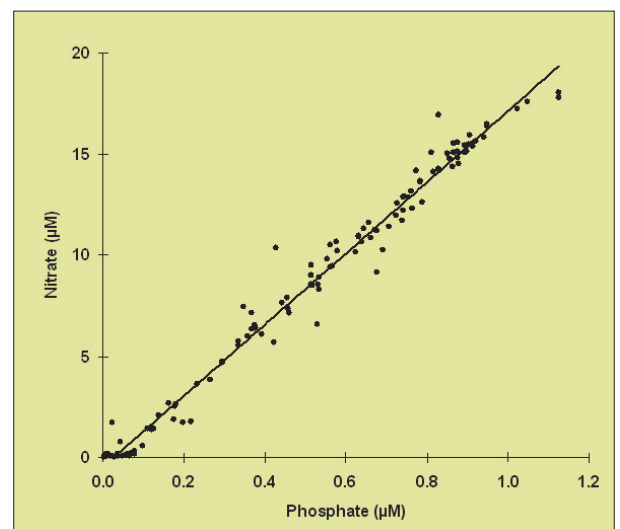

Figure 3.19- Evolution of the concentration of nitrate as a function of the concentration of phosphorus in the water column of the Bay of Biscay. Changes in composition reflect the uptake of nutrients in the surface waters and their release by remineralisation during sinking of detrital organic matter in the water column.

the aquatic system (ULB-OCEAN, ULB-ESA, VUB-ANCH) has even decreased significantly since the recent banning of polyphosphates from washing powders. It is believed that phosphorus may now become the limiting nutrient in estuaries and coastal zones receiving large amounts of anthropogenic N. Phosphorus

## The Role of the Ocean in Global Change

recycling has thus received increasing attention for its important role in coastal ecosystem functioning. Field experiments have shown that phosphorus assimilation is largely associated with bacterial activity. It is gradually becoming recognised that bacterial growth could be limited by phosphorus availability, which in turn could influence the degradation of algal organic matter and thus have an impact on the quality of coastal waters. Phosphorus dynamics is currently studied in the Southern Bight of the North Sea area by ULB-OCEAN and modelled by ULB-ESA. A method based on the uptake of radioactive phosphorus in water samples incubated under natural conditions in the presence of specific biological inhibitors has been developed in order to evaluate the relative role of bacteria, algae, and inorganic processes in the phosphorus cycle (Figure 3.20). The preliminary data show that bacteria are major consumers of dissolved phosphate

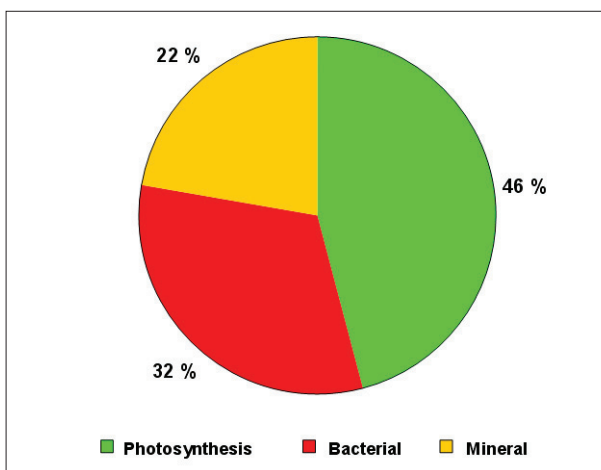

Figure 3.20 - Addition of various biological inhibitors during incubation experiments using radioactive  $PO_4^{3-}$  allows the evaluation of phosphorus uptake via various processes. The results obtained in the highly productive Galician coastal zone show that the contribution of heterotrophic bacterial activity to total phosphorus assimilation could be comparable to that of phytoplankton. The fraction due to mineral reactions is not negligible, indicating high concentration of the particulate phase especially in the coastal area. (ULB-OCEAN).

in the coastal zone. A lack of phosphate could lead to a decrease in bacterial activity and thus to reduction of the rate of recycling of organic matter by bacteria.

### 3.4.4 Silica

It has been shown that anthropogenic activities have significantly increased the flux of nutrients, mainly nitrogen (N) and phosphorus (P), transported by rivers to the North Sea, leading to eutrophication of the Belgian coastal waters. Silicium (Si) in its dissolved form of silica ( $SiO_2$ ) is also an essential nutrient for siliceous plankton such as diatoms, an important food source for marine organisms of higher trophic levels. Diatoms use Si to build their skeleton made of opal ( $SiO_2$ ). In contrast, the major land source of Si, dissolution of silicate minerals, has barely been altered. However, human interventions on the hydrological cycle, such as the construction of dams and sluices, has resulted in an increased retention and trapping of siliceous skeletons of freshwater diatoms in the aquatic continuum from lakes, reservoirs, and rivers, through the estuaries to the coastal zone and open ocean. Consequently, there is an excess delivery of N and P, compared to Si, causing the modification of phytoplankton species composition and thus of ecosystem functioning in many coastal environments. One adverse consequence is the alteration of the marine food web due to the reduced bloom of diatoms. It has been shown that the N and P over-enriched Southern Bight of the North Sea is invaded every spring by blooms of non-siliceous algae (Phaeocystis colonies) that resist grazers and negatively impact the marine ecosystem and environment (ULB-ESA). Higher organisms do not use these Phaeocystis colonies efficiently and the latter tend to form unaesthetic foams on the beaches. This situation contrasts with that of undisturbed environments, where Phaeocystis colonies succeed an early-spring diatom bloom

under the control of silica availability. ULB-ESA has developed a complex 3-D coupled physical-biological model MIRO&CO, which shows that the timing, magnitude, and geographical extent of diatom and Phaeocystis blooms results from the synergy between anthropogenic activities and climate, the latter controlling the inflow of North Atlantic waters and the river discharge into the North Sea. The current SISCO project (Silica Retention in the Scheldt continuum and its Impact on Coastal Eutrophication) carried out by ULB-OCEAN and UGent-PAE aims to better quantify silica fluxes in the Scheldt continuum in order to evaluate their impact on coastal eutrophication processes.

### 3.4.5 Iron

It has recently been demonstrated that the production of organic matter by phytoplankton is limited by low iron availability in the water column of remote parts of the ocean. This is the case of the Southern Ocean, where in situ iron fertilisation experiments have been carried out by several countries. ULB-ESA has developed a model to evaluate the impact of the iron fertilisation on the planktonic ecosystem and the associated biological pump. On the basis of model simulations, the increase in net carbon production in the fertilised patch was estimated to be around 65 g C/m<sup>2</sup> after 60 days. However, much of this production remains accumulated in the upper ocean, so that the predicted downward export of particulate organic carbon represents only 25% of the production.

## 3.5 Is the enhancement of natural processes that transfer CO<sub>2</sub> from the atmosphere into the deep ocean a realistic alternative for mitigating the greenhouse effect?

### 3.5.1 Introduction

CO<sub>2</sub> is one of the primary greenhouse gases. Its estimated contribution to the process of climate change is about two-thirds. Its main sources are associated with the combustion of fossil fuel and it is becoming clear that the introduction of non-fossil energy sources may slow down the build-up of atmospheric CO<sub>2</sub>, but that this will not reduce emissions to the level required by international agreements such as the Kyoto protocol. This has led to increased interest in a new strategy termed 'carbon management and sequestration'. The ocean already contains an estimated 40,000 Gt of carbon, which is more than 50 times the mass of CO<sub>2</sub> presently contained in the atmosphere, and it can easily dissolve large amounts of additional CO<sub>2</sub>. By far, the ocean represents the largest potential sink for anthropogenic CO<sub>2</sub>, and its storage capacity amounts to thousands of Gt of C. In addition, discharging CO<sub>2</sub> directly into the ocean would simply accelerate the ongoing natural processes by which a large part of present-day emissions enters the ocean.

Two processes are currently considered in order to enhance CO<sub>2</sub> storage in the oceanic environment: fertilisation of the marine system and sequestration of CO<sub>2</sub> in the deep ocean. For both processes, large-scale experiments have been performed and patents have already been issued. This is a clear indication that, besides intensive and costly R&D activity by a small number of countries (mainly the USA, Japan and Norway), huge economic interests are involved in the development and exploitation of such technologies. However, there is also some

## The Role of the Ocean in Global Change

concern within the scientific community about the lack of proper assessment of the risks and benefits of these practices and the absence of dialogue on scientific evaluation criteria.

### 3.5.2 How efficiently is fertilisation of the ocean likely to enhance the biological pump?

We have seen in the previous sections that  $\text{CO}_2$  is consumed by phytoplankton to produce organic matter in surface water if sufficient light and nutrients are available. After death of the phytoplanktonic organisms, a fraction of this organic matter sinks to deep waters where it is mineralised and  $\text{CO}_2$  is regenerated. This biological pump is thus a natural way to transfer carbon to the deep ocean. An enhancement of primary production would thus remove more  $\text{CO}_2$  from the surface water and increase its transfer from the atmosphere. On the other hand, phytoplankton is a source of food for higher organisms, and an increase in primary production would theoretically enhance the production of fish at the end of the food chain. It is thus argued that, in addition to the sequestration of carbon, ocean fertilisation would also significantly enhance the fish catch.

Two areas within the ocean are of particular interest because the surface water in these regions still contains N and P, but the growth of phytoplankton is limited by the absence of dissolved iron. These regions are the Southern Ocean and the Equatorial Pacific, where four large-scale iron fertilisation experiments have taken place. One Belgian team (ULB-ESA) participated in the modelling phase of the SOIREE experiment (Southern Ocean Iron Enrichment Experiment). All the experiments confirm that iron fertilisation causes phytoplankton blooms, but some scientists argue that this may be partly because natural predators did not have time to respond to this increase in food supply within

the time frame of the experiment. Furthermore, the phytoplankton assemblage shifted towards the dominance of diatoms, the iron was rapidly removed from the surface water, and the effect of the fertilisation on the sequestration of  $\text{CO}_2$  was limited. Only a very small amount of carbon was transferred mainly to intermediate water, representing a temporary carbon sink of the order of a few years.

In most parts of the ocean, including the coastal zone, productivity is limited by the availability of nitrogen. Hence, the injection of ammonia has been suggested as a way to increase the fish catch and the sequestration of  $\text{CO}_2$ . No large-scale experiments have been performed so far, but some projects are in an advanced stage of preparation.

We know from eutrophication studies that fertilisation may lead to a decrease in biodiversity, to the development of short food webs, and to the bloom of adverse and toxic phytoplankton species. If fertilisation of the surface water can be improved so as to result in an increased flux of organic carbon to deep waters, these waters could rapidly become anoxic owing to the limited amount of oxygen present at great depths and to the absence of supply of this essential gas. Anoxic conditions are responsible for the production of hydrogen sulphide ( $\text{H}_2\text{S}$ ), a highly toxic gas, as well as methane ( $\text{CH}_4$ ) and nitrogen oxides ( $\text{N}_2\text{O}$ ), two gases with a much higher warming potential than  $\text{CO}_2$ . Considering the numerous uncertainties associated with the large-scale application of ocean fertilisation, it is clear that a consensus about scientific evaluation criteria is much needed, but discussion is as yet seriously lacking.

### 3.5.3 Can we envisage injecting pure $\text{CO}_2$ directly into the deep ocean?

In the section devoted to the carbon cycle in the ocean, we have shown that  $\text{CO}_2$  is a very soluble

gas and that a large fraction of the anthropogenic  $\text{CO}_2$  is transferred to and dissolved in the surface water. Owing to the global circulation of water in the ocean and to the existence of the biological pump,  $\text{CO}_2$  is transferred to the deep ocean where it is sequestered for time scales ranging from a few years to millennia, depending on the depth and location. The idea of carbon sequestration via direct injection is to accelerate this ongoing but slow natural process by injecting almost pure  $\text{CO}_2$  directly at depths sufficient to prevent its transfer to surface waters and degassing into the atmosphere. Most of the methods suggested involve first the capture of  $\text{CO}_2$  from large stationary sources such as power plants. Well-developed technologies are available for producing concentrated streams of  $\text{CO}_2$  so that it can be economically transported to deep-sea injection sites, and capturing  $\text{CO}_2$  from power plants is already a commercial process.

Several specific injection strategies have been suggested (Figure 3.21). They are most often based on injection of liquid  $\text{CO}_2$  droplets at a depth below 1,000 m, where the density gradient prevents rapid transfer of the injected  $\text{CO}_2$  to the surface water and its leakage into the atmosphere. Injection of liquid  $\text{CO}_2$  or dry ice (solid  $\text{CO}_2$ ) at great depth near the bottom may have the further advantage of allowing the reaction of  $\text{CO}_2$  with deposited carbonates, forming bicarbonates, which would result in a quasi-permanent sink (several million years) for the gas. The adverse ecological effects linked

to these injections are not very well known. The dissolving  $\text{CO}_2$  droplets produce carbonic acid and lower the pH: in the vicinity of the droplets, the seawater might even reach a pH of about 4, which is certainly harmful for almost all marine organisms. The biomass of organisms living below 1,000 m is very small, however, and impacts associated with pH change could be avoided if the injection system is properly designed to disperse the  $\text{CO}_2$  as it dissolves.

The viability of ocean storage as a greenhouse gas mitigation option will strongly

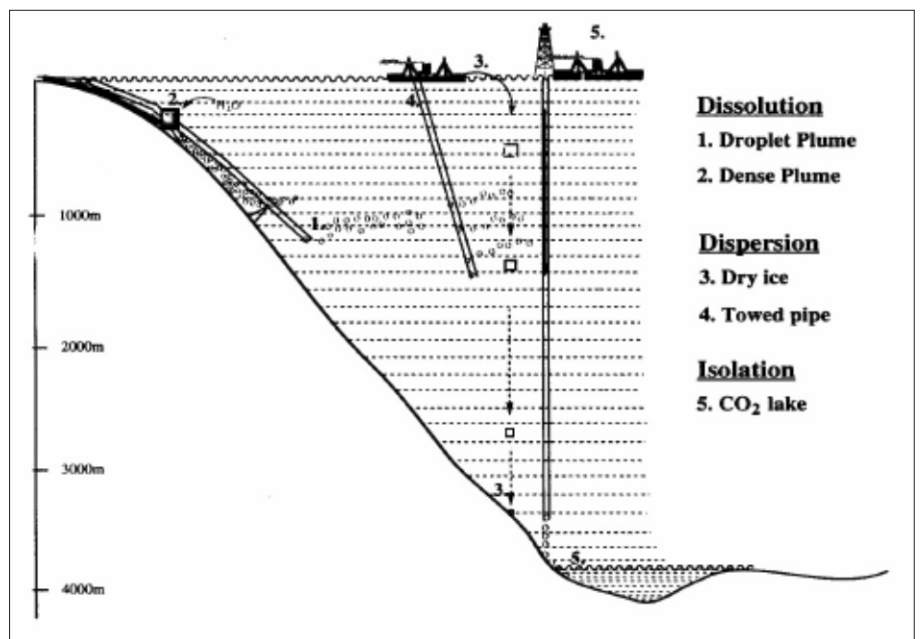

Figure 3.21 - Five suggested methods for injecting  $\text{CO}_2$  into the deep ocean. (Herzog et al., 2001).

1. Droplet plume: liquid  $\text{CO}_2$  injected below 1,000 m from a manifold lying on the ocean bottom and forming a rising droplet plume.
2. Dense plume: a dense  $\text{CO}_2$ -seawater mixture created at a depth between 500 and 1,000 m and forming a sinking bottom gravity current.
3. Dry ice: dry ice released at the ocean surface from a ship.
4. Towed pipe: liquid  $\text{CO}_2$  injected below 1,000 m from a pipe towed by a moving ship and forming a rising droplet plume.
5.  $\text{CO}_2$  lake: liquid  $\text{CO}_2$  introduced into a sea floor depression forming a stable 'deep lake' at a depth of about 4,000 m.

## The Role of the Ocean in Global Change

hinge on social and political considerations. In view of the precautionary principle as regards the ocean, the strategy will require that all parties (public, private, NGO) be associated in the ongoing research and debate.

### 3.6 Key scientific Belgian contributions

Belgian scientific teams involved in marine research have accumulated a wealth of multi-disciplinary experience in the study of the coastal zone, mainly in the Southern Bight of the North Sea. Their research has often been conducted and coordinated on a national basis. They have also participated in several large international projects devoted to shelf and coastal studies, mostly supported by the EU, in the North Sea, the Mediterranean Sea, the Black Sea, the Bay of Biscay, and the Iberian margin. A large part of this research has focused on biogeochemical processes affecting the carbon cycle and related elements such as nutrients and trace metals, both in the water column and in the sediments of the coastal zone. Transfer of components from rivers to estuaries and the adjacent coast were in most cases found to be associated with the marine ecosystem. The Belgian teams are thus well trained and have a considerable background in understanding and quantifying the carbon cycle in the coastal zone, a major research theme in exploring the contribution of the oceanic system to global change. In many cases, prognostic models allowing extrapolation of long-term effects or prediction of changes imposed by management decisions have been developed.

The carbon cycle in the Southern Bight of the North Sea, as established in the Belgian studies, was among the first to be published in the literature. It showed the net autotrophic nature (excess of organic matter production over its respiration) of this coastal ecosystem.

Later measurements of the CO<sub>2</sub> concentration in surface water and of fluxes confirmed the strong autotrophic status of the area from spring to fall.

An extended study of the nitrogen cycle in the water column and sediments and also of the influence of river input, enabled teams to demonstrate the relative importance of nitrogen recycling of N nutrients in the sediments and the limited input of riverine N compounds compared to the large input from the Channel. It was shown in particular that more than 50% of the nitrogen collected by the river Scheldt was lost through denitrification before reaching the sea. This finding was later confirmed for other European and US rivers discharging into the North Atlantic. The studies led also to the conclusion that the main source of nutrients in the coastal zone, on a global scale, is the input of deep ocean water and not river input or atmospheric deposition. This is important from a management standpoint and it explains why the increase in nutrients in the North Sea has rather limited effects as compared to the huge increase in nitrogen and phosphorus species in river water.

The impact of eutrophication on the planktonic assemblage and food web structure was also studied intensively in the Southern Bight of the North Sea. Teams demonstrated a profound modification of phytoplankton populations, showing that the diatom bloom was limited to early April. This has been attributed to the decreased input of dissolved silica by rivers, linked to its present-day consumption in the river system. In the absence of silica, a major nutrient for diatoms, excess left-over nitrate and phosphorus allow the explosive development of *Phaeocystis* colonies, which in turn affects the whole food web structure.

Belgian teams have also been very active in the Southern Ocean, in accordance with the scientific requirements of the Antarctic treaties.



They developed a coupled atmosphere-ocean biogeochemical model (CLIO-SWAMCO) incorporating sea ice interactions explicitly. This model was used in the important international project Southern Ocean Iron Enrichment Experiment (SOIREE) and was the first to include iron limitation for polar waters. In the scope of BELCANTO II, the model is implemented in a three-dimensional framework with the final aim of assessing the sensitivity of the biological pump of the Southern Ocean to climate change.

Belgian teams are working in close connection with foreign teams from all the countries bordering the North Sea. Our know-how is also exploited in several European studies of the marine system. In the framework of the European study OMEX, the production and fate of organic carbon as well as nutrient distribution and fluxes were estimated at the margin of the Bay of Biscay and along the Iberian coast. Carbon and nutrient cycles were also studied and modelled during successive European research projects (European River Ocean System, EROS) in the northwestern Mediterranean Sea (EROS 1) and the northwestern Black Sea under the influence of the Danube (EROS 2). In the Southern Ocean, all field activities of the Belgian teams were performed on board of foreign ships. This has created very close relations with scientists of many countries and has contributed to wide international dissemination of their work.



## 4. Global change impact on ecosystems



### 4.1 What are the impacts of biodiversity loss in a globally changing world and how can it be stopped?

#### 4.1.1 How do ecosystems change when biodiversity declines? Does loss of biodiversity alter the effects of climate change?

Growing awareness of the global loss of biological diversity has enhanced efforts to protect biota against loss of plant and animal species, ecosystems, and habitats (e.g., the United Nations Conference on Environment and Development, UNCED, Rio de Janeiro 1992). The ratification of the Convention on Biological Diversity (CBD) by a large number of countries is one of the outcomes of this landmark conference. In the last few years, a novel potential justification has emerged to warrant conservation and restoration: the functioning of ecosystems may be impaired by loss of biodiversity, and this hypothesis has

become a matter of considerable controversy. Early predator-prey and host-parasite models suggested high sensitivity to invading organisms in natural habitats on small islands (characterised by few plant and animal species) and more frequent insect invasions or pest outbreaks in communities much simplified by man. In other words, increased vulnerability with declining diversity. Since then, many models but only a few field studies have focused on the relationship between loss of diversity and natural ecosystem stability, not seldom with opposite conclusions even though diversity effects were determined in the same way. New types of experiments were required to address these questions regarding the possible biological functions of diversity. In addition, awareness is growing that loss of diversity, a principle factor of global change, will probably modify the way ecosystems respond to other global changes, e.g., alterations in the global climate system. The process of formulating and implementing national and regional programmes aiming at

adaptation to climatic changes, one of the objectives of the UN Framework Convention on Climatic Change (UNFCCC), should start taking into account the fact that the various global changes that affect the planet are interrelated.

Long overlooked aspects of global climate change are extreme events like floods, heat waves, tropical cyclones, etc. General Circulation Models (GCMs) predict increases in such extremes if the human impact on the earth's climate system continues. In experiments that simulate natural heat waves (see Figure 4.1), evidence was found that ecosystem performance (resistance and resilience) under severe climatic disturbance depends on plant species diversity. In the past, both reduced and enhanced stability have been associated with lower diversity, but agreement is growing that biased designs invalidate the conclusions of most of these older experiments because of confounding effects between experimental variables (for example, between resource availability and plant species diversity, or between species identity and species diversity). In research by UA-PLECO and UGent-PP, this problem was overcome by varying diversity as a single factor in artificially synthesised model ecosystems, to mimic real grassland communities that vary in species richness. Survival after an extreme climatic event in these plant communities decreased with increasing species diversity, which could be explained by positive effects of diversity on water use. There was no significant interaction between diversity and species, which implies that all species were affected to the same extent in absolute terms (see Figure



Figure 4.1- Simulation of natural heat waves with suspended infrared heaters (Free Air Temperature Increase technique) at UA. Below the heaters are containers with artificially composed grassland communities with different numbers of plant species, to verify whether loss of plant diversity affects sensitivity to extreme events. (I. Nijs, UA-PLECO).

4.2). In other words, the supplementary loss of survival due to growing in higher diversity was the same in plant species that were affected very little by the stress in monoculture (for example, *Dactylis glomerata*, species F) as in species that were greatly affected by the stress in monoculture (for example, *Festuca rubra*, species D). A surprising conclusion could thus be that loss of diversity does not necessarily make our grasslands less robust in the face of extremes. However, other conclusions can

## Global Change Impact on Ecosystems

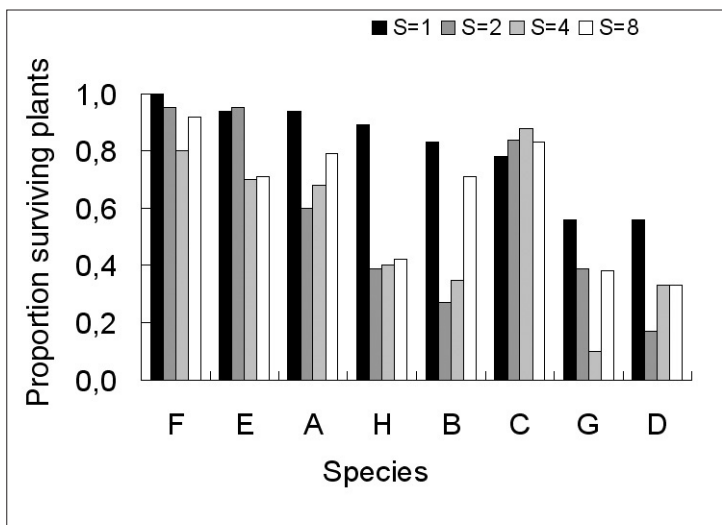

Figure 4.2 - Proportion of plants that survived a simulated heat wave, for different grass species (different letters) grown either in monoculture or together with other species. The plant species richness of the communities is represented by S and the species were ranked according to decreasing survival in monoculture (black bars). With increasing S, fewer individuals survived the heat wave and this effect occurred in all species. Sensitive species (those on the right-hand side of the graph) are more likely to disappear completely when S is higher. Plant species codes: *Lolium perenne* L. (A), *Festuca arundinacea* L. (B), *Poa pratensis* L. (C), *Festuca rubra* L. (D), *Bromus catharticus* L. (E), *Dactylis glomerata* L. (F), *Phleum pratense* L. (G) and *Lolium multiflorum* L. (H). (I. Nijs and L. Van Peer, UAPLECO).

also be drawn. For example, mitigation of global warming protects plant diversity because it prevents species-rich systems from losing their sensitive species (in species-rich systems, the plant species on the right-hand side of Figure 4.2 are more likely to go extinct). This provides a new argument for slowing down climate change. Contrary to survival, regeneration of the fewer survivors of the heat waves was better in initially more diverse systems. While the balance of these changes determines plant productivity in the short run, it can be anticipated that in the long run invasibility will also change, because gap formation and gap size depend on spatial mortality patterns and regrowth.

In other experiments, ecologically complex (grassland) systems were exposed to elevated CO<sub>2</sub> concentrations (700 ppm instead of 360 ppm) and to moderate increases in air temperature (+4°C above ambient continuously), to simulate changes in average conditions several decades from now. The complex systems responded much in the same way as monocultures of the contributing plant species (for example for productivity), in spite of the differences among these

species. This demonstrates that responses of (grassland) ecosystems to changes in average environmental conditions are a poor predictor of responses of ecosystems to extreme events. Future research should take into account the threats associated with extremes, particularly if the frequency and intensity of extremes changes, and should find ways to make ecosystems more robust. Other experimental work, on the influence of diversity on the light regime within plant canopies under unstressed conditions, has led to new insights into the importance of diversity to productivity. It was shown that the presence of more functional groups (a variety of grasses, forbs, nitrogen-fixers) promotes the acquisition of photosynthetically active radiation, not only via more intercepting foliage, but in some cases also via a more efficient interception per unit leaf area (increased extinction coefficient). This provides support for the resource complementarity hypothesis, which states that inter-specific differences in niche exploitation allow a more diverse assemblage of species to absorb more resources. With models, similar results were obtained for the uptake of nutrients. In other words, in the absence of stress, maintaining high (plant) diversity seems to make ecosystems more efficient and seems to reduce the risk of 'leakage' of natural resources. The presence of a diverse array of functional

groups also enhanced productivity in these experiments, possibly because of greater niche differentiation, whereas high species richness of grasses only had no effect. This points to the critical role of inter-specific differences in generating diversity effects, and thus to the importance of avoiding impoverishment, not only in species as such, but also in species with a wide variety of traits or characteristics. Apart from exploring the role of diversity in ecosystems in more detail, future work should give priority to a better understanding of how diversity is regulated in ecosystems, in other words, how can biodiversity be maintained in the long term?

#### **4.1.2 Can management practices counteract loss of plant diversity in agricultural systems?**

Grasslands are among the most important managed ecosystems in Belgium, occupying 50% of the agricultural land surface, or approximately 30% of the total area (compared to, for example, 19% for forest). Grassland functions are diverse, from providing fodder for livestock, stabilising soils, holding carbon stocks, to harbouring plant and animal diversity. The economic function of grasslands is based on the high cost-effectiveness of grasses compared to dry fodder in dairy farming: on a dry-matter basis, the energetic value of grass is similar to concentrates but the cost is only one-third. This is a result of the low energy input into the grassland ecosystem as compared to crops: once grassland is established there are no costs for sowing, harvesting, or chemical protection, only fertiliser costs are to be taken into account. Ecologically, the preservation of the present functions of grassland is a priority because the permanent character of grassland creates a habitat for a large number of plant species. This reservoir of genetic diversity, even in managed grassland, is promoted by the almost

complete absence of the use of pesticides, fungicides, and herbicides in pastures, but can easily deteriorate when nutrient inputs become too high, with supplementary detrimental effects on the quality of run-off and groundwater (cf. EC Nitrates Directive 91/676/EC, which limits nitrate concentrations for drinking water to 50 mg/l). In a broader context, EC agro-environment regulations like EC-2078/92 (replaced by EC-1257/1999 from 1 January 2000) aim at counteracting deterioration of environmental quality in rural areas by promoting sustainable practices. With respect to diversity, a key question is: To what extent can loss of plant diversity be counteracted by new management practices?

Pluri-annual field trials in grasslands have demonstrated that agricultural management (either 100, 250, or 400 kg N/ha/yr and either 3 to 4 or 5 to 6 mowing times/yr) strongly determines plant diversity. The largest numbers of species were recorded under the lowest nitrogen supply combined with the highest mowing frequency. One reason for this is the shorter canopy under intense mowing. This results in enhanced illumination of the ground surface, offering more chances for species to germinate. Also, under a given nutrient supply, a higher mowing frequency removes more nutrients, which leads to a less fertile environment. The resulting reduction in growth rates favours in particular the less competitive species, which increases the total number of species in the system. To enhance the species richness of agricultural grasslands in Belgium, low nitrogen fertilisation (100 kg/ha/yr) is most effective, combined with the highest possible mowing frequency that agricultural practice allows (5 to 6 cuts/yr). This implies a shift from intensive to extensive exploitation, with high costs to harvest the relatively small amount of forage. Note, however, that the results were obtained for continuously mowed grassland

## Global Change Impact on Ecosystems

(standard grassland use either combines mowing with grazing or is limited to grazing only).

### 4.1.3 Are there instruments for predicting species extinctions and developing conservation policies?

If the accelerating global loss of animal and plant species is not rapidly stopped, we may be facing the sixth mass extinction of life on earth. Most causes of this biodiversity crisis identified so far are linked to human activities. Suppressing these threats is a matter of political choice (cf. EC Habitats Directive 92/43/EEC 2.2 on conserving natural habitat and wild fauna and flora; Convention on Biological Diversity, CBD; Convention on International Trade in Endangered Species of Wild Fauna and Flora, CITES). Over the past decades, acid rain has caused extensive withering of forests; water pollution has eliminated many fish species from our rivers; excessive hunting has driven whales and other animal species to extinction. Over-exploitation is responsible for world-wide deforestation and desertification. Global climate change is predicted to have dramatic consequences on our natural environment and its inhabitants. The world's governments have started taking actions against acid rain, greenhouse gas emissions, water pollution, over-exploitation, and some other spectacular curses. Yet less conspicuous factors, linked to human demography, industry, and land use evolution increasingly threaten biodiversity by profoundly modifying the landscape. Slow but continuous habitat destruction and fragmentation are such

underhand threats. They are less conspicuous because the first symptoms are visible only locally. As land use change continues to reduce and destroy suitable habitats, in many species more and more local populations disappear. And the chances become smaller for an empty habitat patch to be recolonised. Several species are now endangered. If the last local population of a species goes extinct before dispersers can successfully colonise an empty habitat patch, then the species has disappeared from the region. Which instruments are needed to make the right decisions that break this chain of events?

The bog fritillary butterfly is a typical candidate for the above scenario in Belgium (see Figure 4.3). Its habitat is wetland. It requires bistort (see Figure 4.4), a herbaceous plant that is disappearing as wetlands are drained or turned into spruce plantations or pasture for cattle. The Lienne valley near Lierneux (Belgian Ardennes) still contains such wetlands with bistorts, and is an important refuge for the bog fritillary in Belgium. 'Still', because 99% of the wetlands present in the Lienne valley at the time when the famous geographer Ferraris

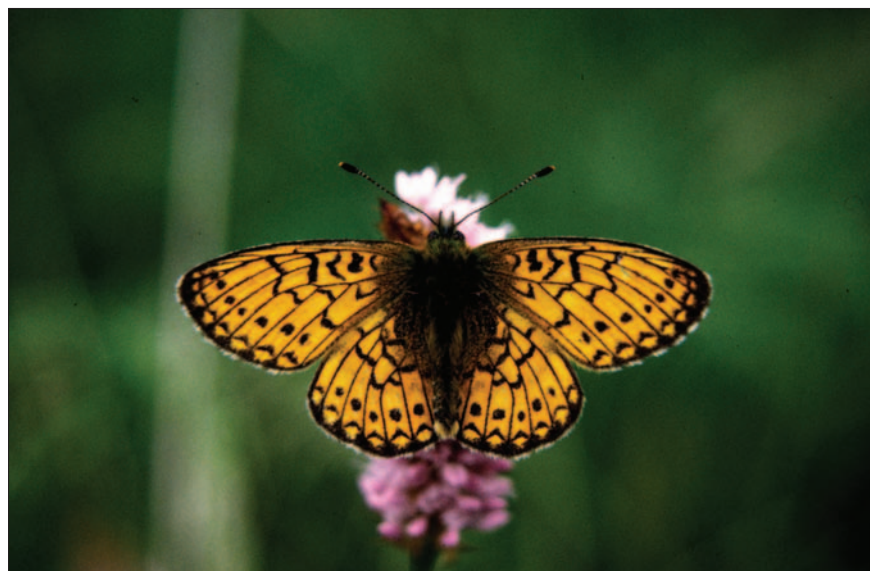

Figure 4.3 - A bog fritillary butterfly, *Eunomia proclissiana*. (E. Le Boulangé, UCL-ECOL).

mapped its vegetation in 1775, have been destroyed, mostly in the last eighty years (see Figure 4.5).

The demography of the bog fritillary has been monitored in the 'archipelago' of



Figure 4.4 - A bistort field in the Prés de la Lienne. (E. Le Boulangé, UCL-ECOL).

remaining habitat patches in the Lienne valley since 1992. Over this period, the number of adult butterflies in the Nature reserve 'Les Prés de la Lienne' fluctuated between 120 and 1,200 individuals, mainly under the influence of climatic conditions and parasitism. On the basis of knowledge of the population dynamics and ecology of this butterfly, and using a recent, sophisticated tool named 'population viability analysis', it has been possible to predict how bog fritillary populations are likely to respond to different scenarios in this area (see Figure 4.6). In 2002, some cattle were introduced into the reserve, a seemingly reasonable management practice, in order to avoid natural forestation of the wetlands. Nevertheless, cows will graze on bistort! With this new parameter, the model predicts a lower future butterfly population and a severely increased risk of extinction. And if ongoing global climate warming is taken into account, then butterfly numbers drop further: the species should then be in danger of extinction in the area – and probably in Belgium. On the basis of these predictions, discussion was initiated with the reserve managers before they released the cattle. As a safeguard, the managers constructed large exclosures to preserve part of the bistort fields from being

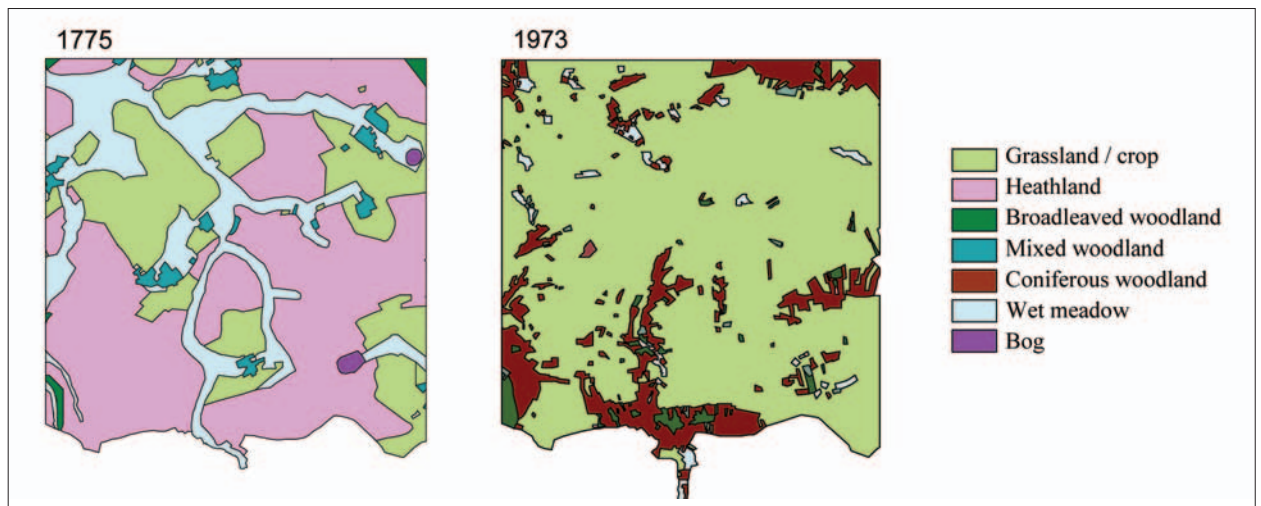

Figure 4.5 - Loss of wetland vegetation in the Lienne valley between 1775 and 1973. (E. Le Boulangé, UCL-ECOL).

## Global Change Impact on Ecosystems

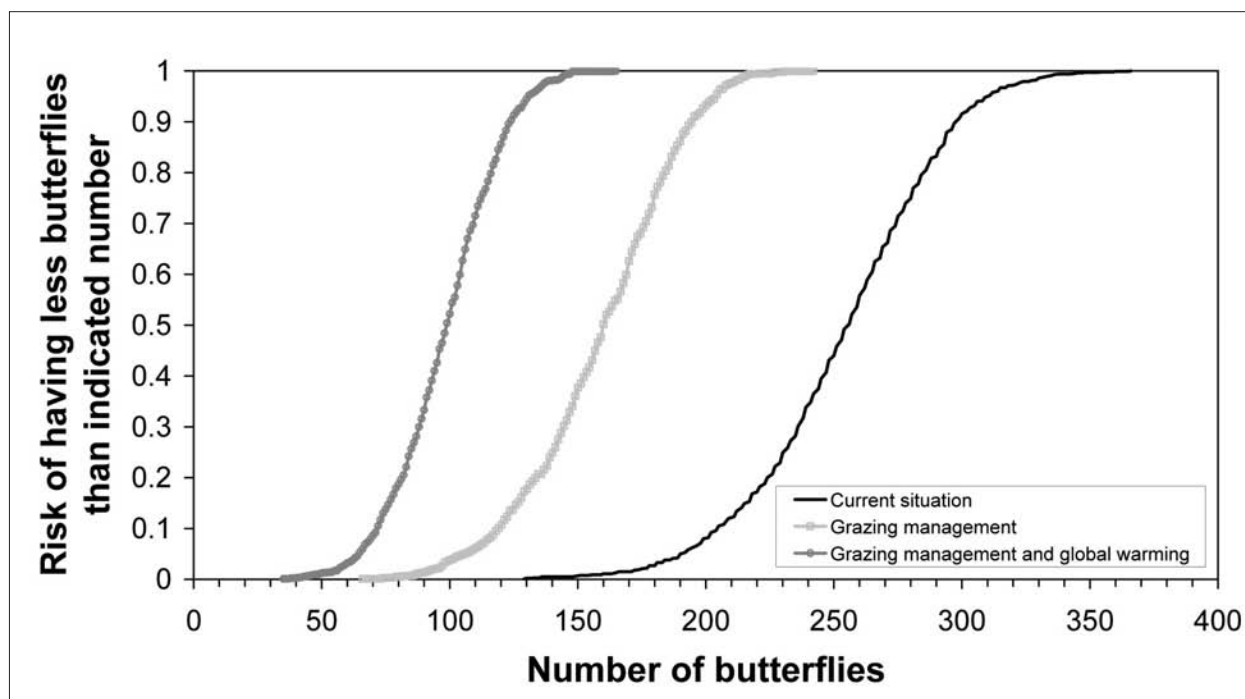

Figure 4.6 - Model results predicting extinction risk in butterflies. (E. Le Boulangé, UCL-ECOL).

grazed. This allows researchers to verify whether the presence of cattle indeed threatens the survival of the bog fritillary as predicted by the model, thus providing nature reserve managers with the opportunity to react before it is too late. Of course, this is only a specific example. The scientific community now works on developing models that can be adapted to different landscapes, regions, and sets of species, thus providing reserve managers with tools for evaluating the impact of management scenarios before they are applied.

### 4.2 What are the interactions between ecosystem functioning and CO<sub>2</sub> and non-CO<sub>2</sub> greenhouse gases?

#### 4.2.1 Are Belgian terrestrial ecosystems a carbon sink?

Photosynthesis, plant respiration, and soil fauna respiration control the carbon (C) fluxes between the atmosphere, the terrestrial vegetation, and the soil compartment. The accumulation of

C in terrestrial ecosystems depends on net ecosystem production (NEP), which is the difference between plant photosynthesis and respiration by plants and soil organisms (the heterotrophic flux in Figure 4.7).

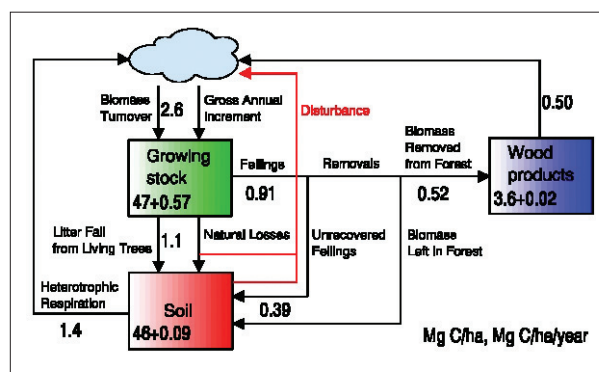

Figure 4.7 - Scheme of the interrelation between C stocks (growing stock, wood products, soil stock), and fluxes (felling flux, heterotrophic respiratory flux), according to the EFISCEN model (European Forest Information Scenario Model). (courtesy of Pussinen et al., 2000).

Although many factors influence these processes, temperature and precipitation are the most important on the global scale. It is

therefore not surprising that global ecosystems show a strong latitudinal gradient, reflected also in soil organic C (SOC) pools. Additionally, water logging slows down decomposition rates of organic matter owing to the anaerobic conditions that prevail under these circumstances. Concerning the interrelation between stocks (growing stock, wood products, soil C stock) and fluxes (felling flux, heterotrophic respiratory flux), forest types can be described by area, volume, and net annual increment by age class. The EFISCEN model (European Forest Information Scenario Model) contains 2,689 forest types in Europe. The state of the forest is depicted as an area distribution over age and volume classes in volume-age matrices. Separate matrices are established for each type of inventory data (for example, land use cover, forest floor cover, etc.). The projection of growth in the model is based on growth functions calibrated with inventory data. These inventory data usually represent the situation in a country from the mid 1980s to the mid 1990s. Therefore, the results, as presented here in Figure 4.7 for the year 1999 for Europe, have the underlying assumption that growth has not changed since then. The results are of direct relevance within the framework of the Kyoto

Protocol (articles 3.3 and 3.4), the subsequent COPs (Conferences of the Parties), and the commitments made by the federal authorities with respect to UNFCCC, and in particular to the interpretation of article 2.

Forest management is controlled at two levels in the model. First, a basic management for each forest type, such as thinning and final felling regimes, is incorporated. Thinning regimes are incorporated as the range of age classes at which a thinning can be carried out. Final felling regimes for each age class are incorporated as a probability that final felling can be carried out. Secondly, the required total harvest volume from thinning and final felling is specified for a whole country for each tree species group and for each time period. In Figure 4.7, turnover rates for each compartment per tree species and age class quantify the litter input to the soil. Since mass flux estimates in the EFISCEN model are calculated at country level, a country is therefore adopted as the basic spatial unit of the EFISCEN model. Re-iterating on soil carbon stocks, on a regional scale, additional factors such as vegetation and soil type are needed to explain the spatial variation in SOC contents. It is well known that differences in allocation of C in woody and non-woody tissues, above- and

Table 4.1 - C stocks and fluxes for Belgian terrestrial ecosystems and soils. (F. Veroustraete, VITO-TAP and B. Van Wesemael, UCL-GEOG).

Stocks	Per unit area (ton C/ha)	Totals for Belgium (kton C)
Forest biomass	94.4	53,800
Soil (from national soil survey 1950-1970)		
Humus layer in forests	61.5	35,000
Soil (0-30 cm)	58 (10-190)	144,000
Soil (0-100 cm)	98 (18-986)	241,000
Fluxes	Per unit area (ton C/ha/yr)	Totals for Belgium (kton C/yr)
All vegetation NEP	4.8	14,600
Forest biomass accretion (NEP)	5.0	2,800
Forest felling	2.1	1,200
Soil as a result of management	?	500-800



## Global Change Impact on Ecosystems

below-ground biomass, and lignin content in the leaves between vegetation types have a strong impact on decomposition rates and consequently on the size of SOC pools. Differences between SOC pools in deciduous (120 ton C/ha) and coniferous forests (150 ton C/ha) are generally explained by the influence of litter quality on decomposition rates. Furthermore, litter quality affects the degree of biological activity and the mixing of organic matter into the mineral soil. Hence, litter from deciduous trees is mixed into the topsoil, resulting in mull-type humus, whereas under coniferous trees a thick layer of partly decomposed organic matter remains at the surface (moor-type humus).

The difference in SOC pools between grasslands (140 ton C/ha) and forests (120 ton C/ha) within the same climate is more difficult to explain. On the one hand, a higher proportion of litter in grasslands consists of roots. These decompose more slowly than the aboveground input of leaf litter and woody litter in forests, and they also contribute directly to the SOC. On the other hand, it is argued that the higher proportion of non-woody biomass in grasses with lower lignin content would induce an increase in decomposition rates and therefore result in a smaller SOC pool under grassland than under forest. Soil texture determines the water holding and nutrient retention characteristics. All other factors being equal and owing to its greater fertility, a clay soil will generally promote a higher net primary production (NPP) and, because of impeded drainage, a lower rate of organic matter decomposition. Furthermore, the large specific area of a clay soil promotes the formation of a stable clay humus complex, thus protecting organic matter from microbial attack. It has been shown that the Central Great Plains (USA) clay soils, with the highest predicted SOC content, have low predicted relative SOC losses under cultivation. Conversion between land use types is likely to have an impact on the input

of organic matter to the soil (in terms of both quantity and quality) and on mineralisation rates. It is well known that conversion from forest or grassland to arable land results in a rapid decline of SOC. Upon conversion, the return of organic residues to the soil decreases. The rate of residue decomposition might increase, and tillage provides extra oxygen to the soil for the decomposer organisms and breaks up the soil aggregates that protected organic matter against microbial attack.

A preliminary budget of C stocks and fluxes in Belgian terrestrial ecosystems is presented in Table 4.1. The data were collected with different methodologies. The Flemish and Walloon regional forest inventories yield forest biomass data by means of a recalculation of wood volume. The soil data refer to SOC determined for surface soil of a specified thickness (forest floor or humus layer, the 0-30 cm or 0-100 cm mineral soil). Data from more than 13,000 geo-referenced soil profile descriptions, collected between 1950 and 1970, are used to assess the average and ranges of SOC stocks in Belgian soils. The CASTEC (Carbon Sequestration in Terrestrial Ecosystems) and METAGE (Modelling Ecosystem Trace Gas Emissions) projects are updating the C stock data, using routine soil fertility analyses for arable and grassland soils and forest inventory data for forest soils. SOC stocks for 1990, 1995, and 2000 will be available shortly. Carbon fluxes from vegetation and forest were determined using a production efficiency model. The C fluxes associated with harvesting of timber are derived from the regional forest inventories. Under forest, the soil C pool, including the humus layer, is of the same order of magnitude as, or even larger than, the forest biomass pool (Table 4.1). This is in accordance with the ratio between the soil and biomass pools in European forests (see Figure 4.7). The wide range of the estimates of the soil C pool reflects the variation in land use, climate, and soils on a

national scale. In general, C stores and fluxes, calculated on an area basis, are higher than the European average because of the favourable temperature and precipitation conditions in Belgium (see Figure 4.7). The total amount of C stored in Belgian soils (276,000 kton C: humus + soil 0-100 cm, see Table 4.1) largely exceeds that stored in the forest biomass (53,800 kton C). Changes in soil C could therefore have an important impact on the national greenhouse gas balance. Further research is needed to quantify the soil C pool and possible changes resulting from changes in land use, land management, and climate. Currently, we can only identify accretion in woody biomass of forests (2,800 kton C/yr) and harvest from wood products (1,200 kton C/yr) as possible long-term sinks of C. It should be noted that a large part of the harvest remains in the forest and is decomposed or enters in the soil C pool (see Figure 4.7).

These two possible C sinks represent approximately 14% of the Belgian CO<sub>2</sub> emissions in 1990 (28,200 kton C). Belgian NEP (Net Ecosystem Production), as estimated with a process-based C model, is about 14,500 kton C/yr for January 1997 - December 1997 and April 1998 - March 1999. Belgian forest NEP is about  $2.7 \cdot 10^6$  kton C/yr or 17-18% of the NEP of all types of vegetation. Figure 4.8 gives an example of the all-vegetation NEP spatial pattern. It illustrates the yearly NEP for 1997

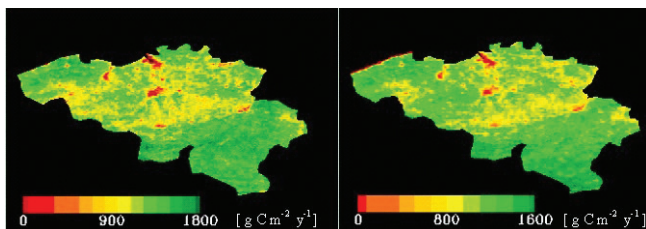

Figure 4.8 - Belgian Net Ecosystem Production (NEP) for a mix of all vegetation cover types, spanning a period of two years, obtained with data from the NOAA-AVHRR and SPOT4-VGT as inputs for C-Fix, a satellite-based carbon budgeting tool. (F. Veroustraete, VITO-TAP).

and the period April 1998 – March 1999. Clearly, the southern part of Belgium, with the highest forest probabilities (see Figure 4.9), elicits a significantly higher NEP than the northern part of Belgium. Brown-red areas in both images are large cities like Brussels, Antwerp, and Gent with NEP values close to zero.

The geographical pattern of NEP is different in the two images, owing to differences in the

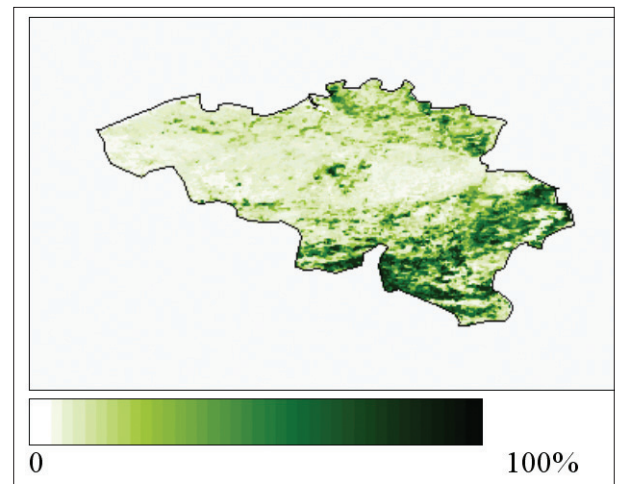

Figure 4.9 - FIRS AVHRR-based forest probability map of Belgium for 1997. Forest probability is expressed as a percentage in this map. (Courtesy of the FIRS project, Forest Information from Remote Sensing).

meteorological data sets, interpolation schemes, and imagery used. Although these maps are somewhat different, estimated annual NEPs are nearly identical for the two years (4.79 and 4.76 ton C/ha/yr). In summary, the yearly mean NEPs for Belgium as obtained with two different sensors and two different meteorological data sets (those for 1997 and 1998-1999) are 4.76 and 4.79 ton C/ha/yr respectively. The observations and negligible differences for yearly total NEP are summarised in Table 4.1. To extract forest ecosystems from all vegetations in a pixel, a digital forest probability map was used (see Figure 4.9). It gives the probability for a certain fractional forest cover in a sensor pixel. Fractional forest cover probability is expressed as a dimensionless variable

# Global Change Impact on Ecosystems

varying between 0 and 1. The map is combined (multiplied) with an all-vegetation NEP map from the process-based model on a pixel-per-pixel basis. The forest probability map indicates the distribution, fractional cover per pixel, and density of forested areas for Europe. A forest NEP map is obtained by multiplying the corresponding pixel values of the forest probability map and the modelled all-vegetation NEP map. According to the forest probability map, the total forested area in Belgium equals 5,482 km<sup>2</sup>, about 19% of the total surface area of Belgium. It can clearly be observed that the pixel forest probability is low in the Flanders region and much higher in the Walloon region. In Flanders, the forest is much more fragmented than in the Walloon region.

Figure 4.10 illustrates Belgian soil C stocks for the period 1950 – 1970. There is a clear-cut relationship between the zones in Figure 4.8 with a high C fixation activity and with a high forest probability. In contrast, agricultural zones have a much lower C stock in soils than the previously mentioned vegetation type. Clearly, this is why there is a very nice geographical correspondence between soil C stock patterns in Belgium and vegetation productivity.

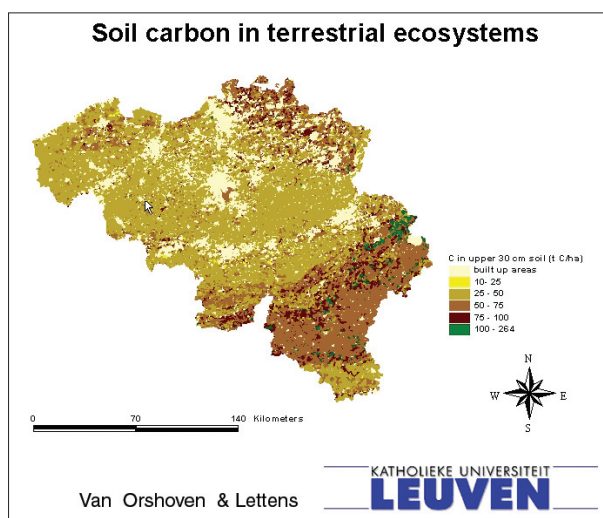

Figure 4.10 - Belgian soil C stocks for the period 1950 – 1970. (Lettens et al., 2004).

## 4.2.2 Do non-CO<sub>2</sub> emissions from agriculture contribute significantly to climate change?

Several biogeochemical processes in terrestrial ecosystems contribute to the formation and sorption of reactive trace gases such as CH<sub>4</sub> (methane), N<sub>2</sub>O (nitrous oxide), and NO<sub>x</sub> (total nitrogen oxides). All these compounds affect, to a certain extent, the radiative forcing or the ozone level of the atmosphere (see Chapter 1). Methane and nitrous oxide are important greenhouse gases. Nitrous oxide also contributes to stratospheric ozone (O<sub>3</sub>) depletion, while nitric oxide (NO) is a precursor of tropospheric O<sub>3</sub>. Nitric oxide contributes significantly to acid deposition and indirect N<sub>2</sub>O emissions from soils. Exchange of CH<sub>4</sub>, N<sub>2</sub>O, and NO between terrestrial ecosystems (biosphere) and the atmosphere plays a significant role in the global budgets of these trace gases. The sink strength of aerobic soils for atmospheric CH<sub>4</sub> has been estimated at 29,000 kton CH<sub>4</sub>/yr, with a very high uncertainty. This is 6% of the tropospheric CH<sub>4</sub> oxidation capacity. On the other hand, natural and agricultural soils are the most important global source of N<sub>2</sub>O and they represent about 60% of global N<sub>2</sub>O emission. Nitric oxide emission from soils is thought to contribute 13,000-21,000 kton N in NO/yr to global emission (24,000-54,000 kton N in NO/yr). It has been demonstrated that the sink and source functions of aerobic soils for CH<sub>4</sub>, N<sub>2</sub>O, and NO depend largely on land use, land management (e.g., fertilisation), and climate (soil temperature and moisture). In general, conversion of natural soils to agriculture reduces the sink strength for CH<sub>4</sub> and enhances N<sub>2</sub>O emission.

During different BELSPO projects, different field monitoring campaigns were carried out to develop direct N<sub>2</sub>O and NO emission factors (EF) for Belgian agriculture. The campaigns covered arable land and grassland (mown and grazed)

located in different agro-pedological zones of Belgium. During the 1992-1995 campaign, an  $N_2O$  EF of 2.4% of the applied fertiliser N was found. During the 1997-2000 campaign, this was 5.3%. When the two monitoring campaigns were combined, an average  $N_2O$  EF for Belgian agriculture of 3.4% could be proposed. These results reveal that (i) the uncertainty of  $N_2O$  emission from terrestrial ecosystems is large and (ii) the  $N_2O$  EF for intensive agricultural systems in Belgium is larger than the default direct  $N_2O$  EF in the 1996 IPCC (Intergovernmental Panel on Climate Change) Guidelines for National Greenhouse Gas Inventories. The uncertainty and the knowledge gap for  $NO$  EF for agricultural ecosystems are even greater. For a limited number of continuous measurements, an  $NO$  EF between 0.3 and 7.1% of the applied fertiliser N was found. Terrestrial ecosystems (especially forests and other undisturbed terrestrial ecosystems) can act as sinks for  $CH_4$ , but also for  $N_2O$ . Hence, land use change and land disturbance are significant controlling factors. The conversion of natural ecosystems (such as forest and natural grasslands) to

agricultural land will increase  $N_2O$  emissions and reduce  $CH_4$  oxidation. This introduces two negative effects with respect to greenhouse gas fluxes. The effect of land use on biological  $CH_4$  oxidation is clearly shown in Figure 4.11.

In the above-mentioned study, no fertiliser effect was observed, although laboratory experiments showed a clear inhibitory effect of  $NH_4^+$  on  $CH_4$  oxidation. Belgian forests showed a small  $N_2O$  uptake capacity. In general, the  $CH_4$  uptake capacity of Belgian grassland and arable soils was estimated at 1.03 and 1.99 kton  $CH_4$ /yr respectively. Direct  $N_2O$  emission from agricultural soils (grassland and arable land) was estimated at 7.56 kton  $N_2O$ -N/yr. Varying emission and uptake of non- $CO_2$  greenhouse gases from terrestrial ecosystems are important with respect to the total greenhouse gas budget when C sequestration is considered as a  $CO_2$  mitigating option. Through meta-analysis, independent field experiments on  $N_2O$  emissions can be compared and effect sizes can be calculated so as to assess the importance for direct  $N_2O$  emission from agricultural soils of controlling factors such as fertiliser N application rate, climate (soil temperature and moisture), soil fertility (C and N content), texture, drainage, and pH.

This effect size index will be used in empirical models for  $N_2O$  fluxes from agricultural soils. These results are of direct relevance to the Kyoto Protocol (articles 3.3 and 3.4), the subsequent COPs (Conferences of the Parties), and the commitments made by the federal authorities with respect to the UNFCCC, in particular to the interpretation of article 2.

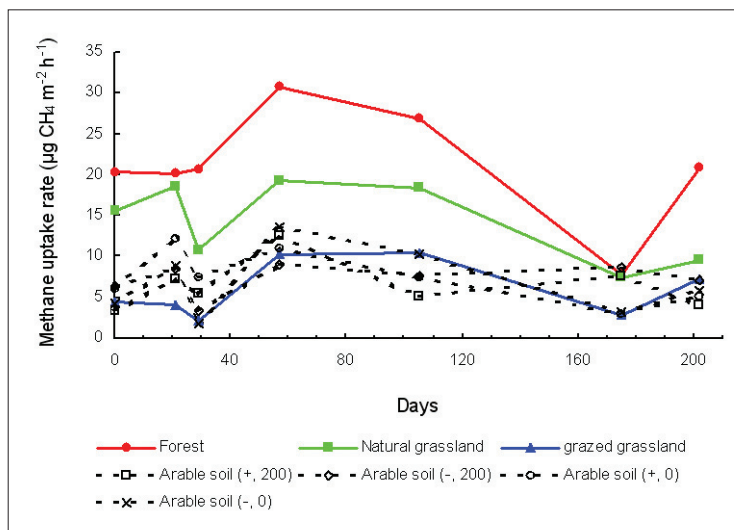

Figure 4.11 - The effect of land use on the  $CH_4$  uptake capacity of terrestrial ecosystems; '+' indicates fertilisation with 175 kg  $NH_4NO_3$ /ha and '200' fertilisation with 200 kg N/ha as slurry. (P. Boeckx, UGent-ISOFYS).

### 4.2.3 What is the variability of the terrestrial sink on an interannual timescale?

C sequestration shows significant year-to-year fluctuations on both the local and global

## Global Change Impact on Ecosystems

scales, associated with weather variability. It is important to understand variations in C sequestration on this time scale, since (i) the current state of a forest plot or global biosphere in terms of C sequestration must be defined over at least a decade, and (ii) this inter-annual variability of the system enables researchers to test the response of ecosystem models to changes in climatic variables.

On a global scale, the inter-annual variability of the biospheric  $\text{CO}_2$  sink is dominated by the variability of the weather system, associated with the El Niño phenomenon (see Chapter 2). These variations of the biospheric sink (the net  $\text{CO}_2$  flux from the atmosphere to the biosphere) can be evaluated from (i) inverse studies using measurements of atmospheric  $\text{CO}_2$  concentrations and isotopic compositions

at various sites of a global network, and (ii) global biosphere models. Figure 4.12 shows the comparison of predictions made with the CARAIB biosphere model of ULg-LPAP with those of a global inversion study for the period 1980-1993. Both methods suggest that the biospheric sink was strongly reduced (or changed sign) during the El Niño events of 1983-1984 and 1987-1988. As suggested by the biospheric model, these variations are largely associated with changes in tropical ecosystems (tropical rainforest, tropical seasonal forest, and savannahs) and involve both the photosynthetic and respiration processes. On a local scale, the inter-annual variability of C sequestration depends on the variability of regional weather conditions, on possible alterations of productivity linked to tree diseases, and on changes in land

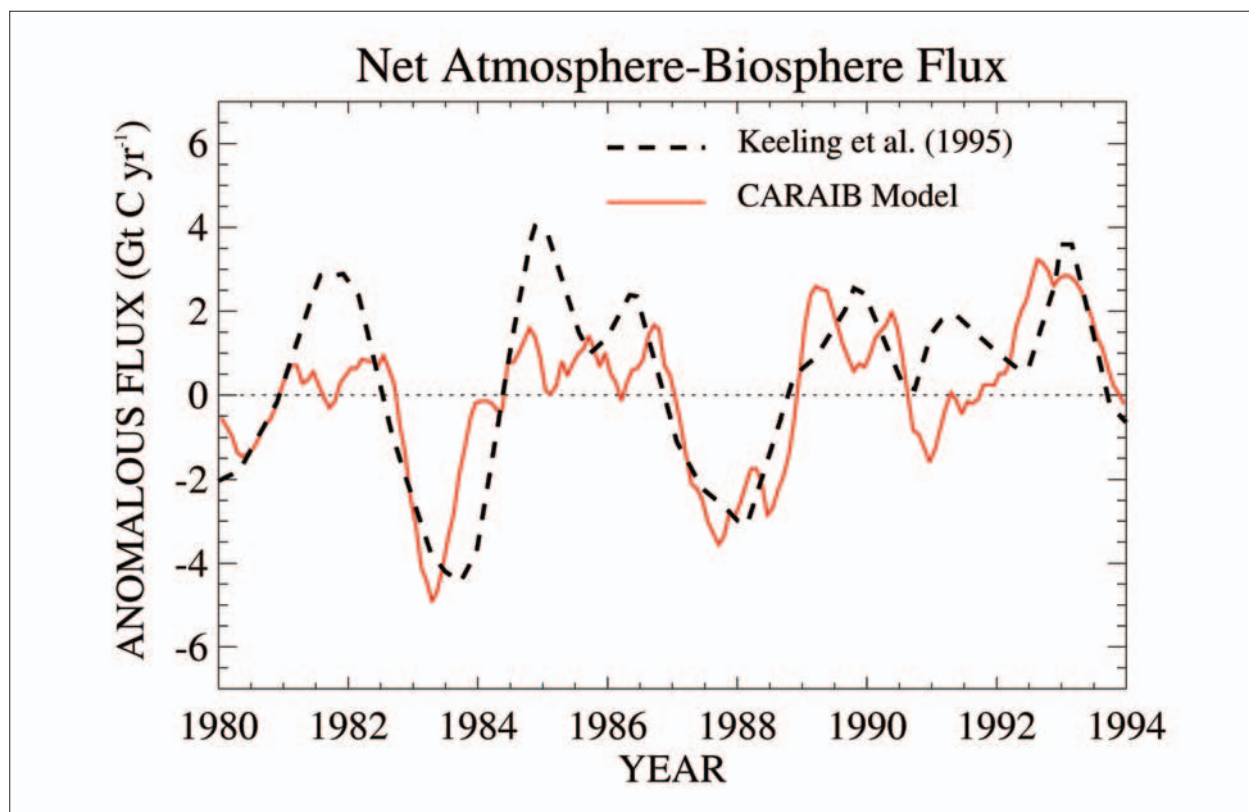

Figure 4.12 - Net  $\text{CO}_2$  exchange flux between the atmosphere and the land biosphere over the period 1980-1993, calculated by the CARAIB model (Carbon Assimilation In the Biosphere, ULg-LPAP) and reconstructed by Keeling et al. (1995) from atmospheric measurements of  $\text{CO}_2$  concentration and isotopic composition. The reported values are the differences (anomalies) with respect to the 1980-1993 average. (L. François, ULg-LPAP).

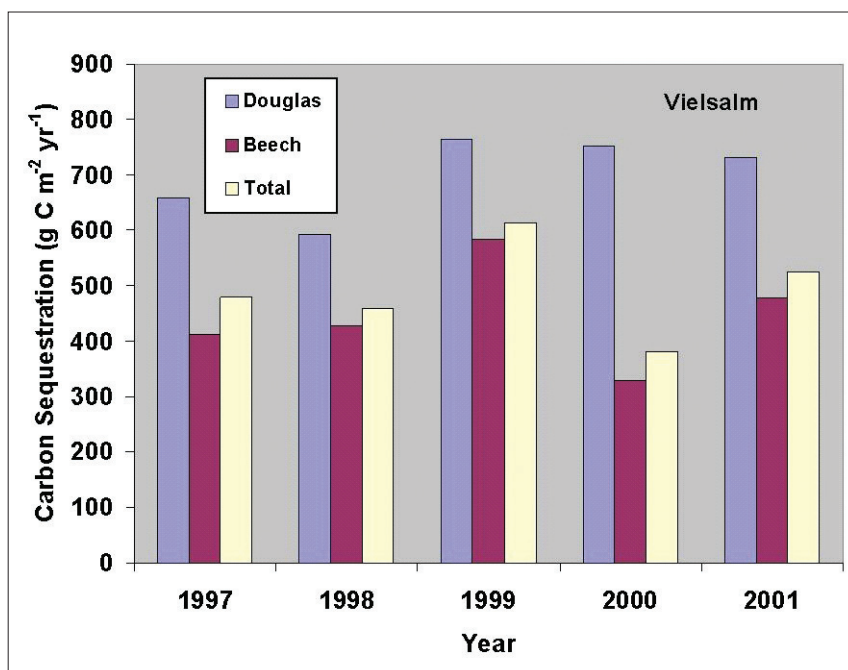

Figure 4.13 - Amount of C sequestered annually as measured over the period 1997-2001 at the Vielsalm experimental station (Belgium). The measurements were performed with an eddy covariance system by FUSAGx. Separate estimates are provided for the whole forest plot (total) and for the Douglas fir and beech contributions. (L. François, ULg-LPAP).

use and management practices.

Figure 4.13 shows the variation of annual C sequestration measured between 1997 and 2001 at an experimental station in Vielsalm (Belgium). This mixed temperate forest site is composed mostly of Douglas fir and beech trees. It is equipped with an eddy covariance system measuring heat, water, and CO<sub>2</sub> exchanges between the atmosphere and the forest ecosystem. Over this period, an average C sequestration of 492 g/m<sup>2</sup>/yr was measured for the whole plot. Relative fluctuations of almost 50% around this mean are observed.

#### 4.2.4 What is the ratio of anthropogenically emitted carbon to carbon fixation by European forests?

Current anthropogenic emissions of CO<sub>2</sub> result primarily from the consumption of energy from fossil fuels. Estimates of annual global emissions

from fossil fuel combustion and cement production have been made for the period from 1751 through 1999, reaching a maximum of  $6.6 \cdot 10^6$  kton C/yr in 1997 ( $0.2 \cdot 10^6$  kton C/yr of this was from cement production). The average value of emissions for the 1980s is  $5.4 \pm 0.3 \cdot 10^6$  kton C/yr, revised from the earlier estimate of  $5.5 \pm 0.3 \cdot 10^6$  kton C/yr used in the Special Report on Radiative Forcing of IPCC.

Estimated global emissions

rose from  $6.1 \cdot 10^6$  kton C/yr in 1990 to  $6.5 \cdot 10^6$  kton C/yr in 1999. The average value of emissions in the 1990s was  $6.3 \pm 0.4 \cdot 10^6$  kton C/yr globally. Figure 4.14 gives an overview of C emissions for Europe from UNFCCC in 1997, excluding Land Use Change and Forestry (LUCF) effects.

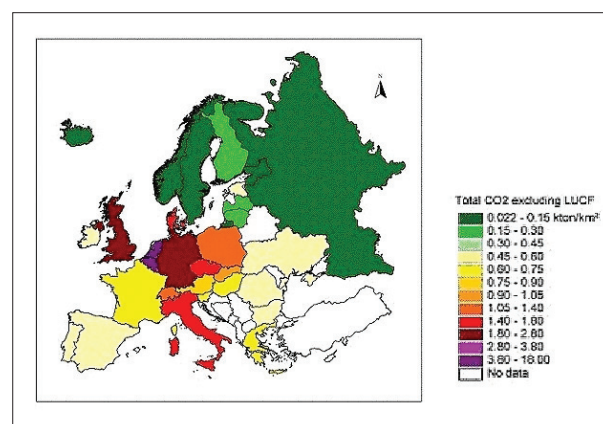

Figure 4.14 - UNFCC C emissions for Europe in 1997, excluding Land Use Cover Change (LUCF) effects. (F. Veroustraete, VITO-TAP).

Table 4.2 lists CORINAIR (Core Inventory of Air Emissions) 1990 emissions for 27 countries of Europe and for different sectors. Total C emissions amount to  $128.6 \cdot 10^3$  kton

## Global Change Impact on Ecosystems

or 128.6 Tg C/yr. Forests play a major role in the global C cycle and global C balance. Not only do they represent a large C pool of the terrestrial compartment, but they also act as important C sinks. In old forests, huge amounts of C, taken up from the atmosphere, are locked away not only in the tree trunks and branches but also deep in the soil where the C can reside for several centuries. The observed results will contribute to the Kyoto Protocol, but also to the priorities of Chapters 10-14 of AGENDA 21 (1992) concerning the sustainable development of natural resources. Furthermore, the results will also be useful towards meeting commitments related to the Helsinki (1993) and Lisbon (1998) Ministerial Conferences on the Protection of Forests in Europe (MCPFE), particularly with respect to the sustainable management of forests and to strategies for long-term adaptation of forests to climate change.

The above results are in accordance with data for the Belgian functional forest types examined over the past four years. Forestry projects can offer a low-cost alternative C sequestration option, as they can be compatible with other environmental, economic, and socio-developmental priorities, and as they are an important component in reducing greenhouse

gases. CO<sub>2</sub> emissions could be sequestered through several types of forestry intervention, such as management, reforestation, afforestation, or conservation, each entailing a different C accumulation rate, project length, and cost. Afforestation, reforestation, and projects to reduce the impact of logging operations are some of the activities that were considered for inclusion under UNFCCC's Clean Development Mechanism (CDM). Forests around the world are under pressure, and C-financed forestry projects could include conservation, reforestation for ecological restoration or wood products, biomass energy, and forest management or other purposes. Distinct from traditional forest management, C projects could be undertaken primarily to sequester CO<sub>2</sub> in wood products. Estimates by computer models of both baseline and projected C sequestration by forests are a requirement of these future projects. Compared to other forest interventions, plantations generally exhibit higher growth rates, and therefore higher C sequestration rates. Plantation trees are generally grown for commercial timber supporting processing and manufacturing industries. These can complement C sequestration projects. Plantation species have also been widely studied with respect to site requirements, establishment practices, silvicultural management and likely growth rates.

Although it was generally believed that the planting of new forests would be an ideal strategy for absorbing CO<sub>2</sub> - hence offering remediation for increasing concentrations of greenhouse gases - a recent study by the Max Planck Institute for Biogeochemistry in Jena (Germany) casts doubt on this concept. The study generated a view illustrating that mature forests differ sharply from long-held notions in forestry.

Table 4.2 - CORINAIR (Core Inventory of Air Emissions) 1990 Emission data in Tg C/yr (1 Tg = 10<sup>9</sup> kton). (F. Veroustraete, VITO-TAP).

CO <sub>2</sub> emissions from Europe (27 countries)	(Tg C/yr)
1. Public Power, cogeneration and district heating	36.3
2. Commercial, institutional and residential combustion	22.6
3. Industrial combustion	30.9
4. Production processes	4.8
5. Extraction and distribution of fossil fuels	0.7
6. Solvent use	0.0
7. Road transport	18.0
8. Other mobile sources and machinery	3.7
9. Waste treatment and disposal	2.2
10. Agriculture	0.6
11. Nature	8.0
<b>TOTAL</b>	<b>128.6</b>

Ageing forests have long been perceived as being in a state of decay that releases as much C as it captures. Figures can illustrate the C fixation capacity for Europe and Belgium. The total C fixation for all vegetation in Europe is around 111,000 kton C/yr, which represents some 7-12% of European anthropogenic CO<sub>2</sub> emissions. High mean values of C are found in the southern and eastern parts of Europe. We must note that some countries are not completely in the region of interest, for example the Asian part of Russia (only the European part was considered in the studies). France has the highest C fixation expressed as a percentage of total European C fixation. The highest mean C fixation is found in Ireland, with a value of 60 ton C/ha/yr. This number is twice the value of other countries, which sometimes have greater forested and/or agricultural surface areas. Northern areas like Scandinavia have a low mean C fixation value due to the short growing season and lower mean temperatures. In this respect, NEP fluxes decrease strongly as a function of increasing latitude. Total forest C fixation is estimated to be 700 kton C for 1997 for the region of interest of Europe, adding up to 30% of the total European NEP of all vegetation. The highest mean forest C fixations are found in Croatia, Slovenia, Serbia, and the countries near the Adriatic Sea. Figure 4.15 illustrates the forest NEP distribution for Europe for 1997, as simulated with the C-Fix model. The C-Fix model is based on an elementary Monteith-based model in combination with remotely sensed imagery and standard meteorological inputs, to estimate the temporal and geographical distribution of its relevant carbon fluxes. The C-Fix model attempts to quantify carbon fluxes on a regional and continental basis, by combining a simplified carbon exchange model, ingesting only a moderate number of input parameters, with satellite observations. In general, the most productive forests are found in southern Europe.

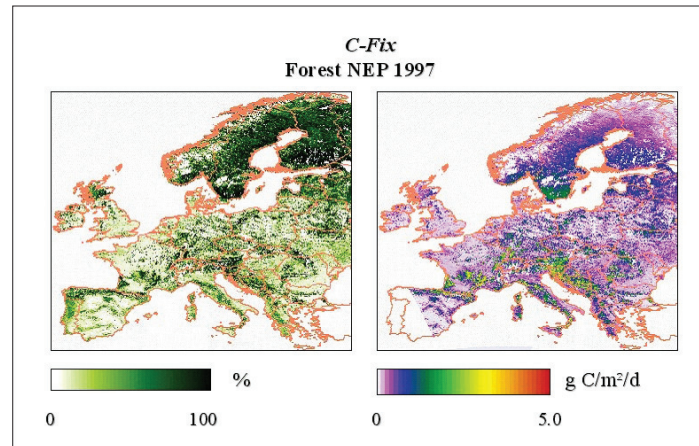

Figure 4.15 - Forest Net Ecosystem Production (NEP) for the European continent in the year 1997, use being made of a forest probability map from the FIRS (Forest Information from Remote Sensing) project (output of the C-Fix model, F. Veroustraete, VITO-TAP).

Finally, Figure 4.16 illustrates the balance of C emissions versus NPP for most of the European countries. It can be seen that almost no country in Europe can balance out its C emissions with the C fixation capacity of its forests. For example, the Benelux emits approximately 50 times more CO<sub>2</sub> than it can reabsorb with its forests. These countries, hence, are completely out of balance in terms of emission versus re-absorption of C.

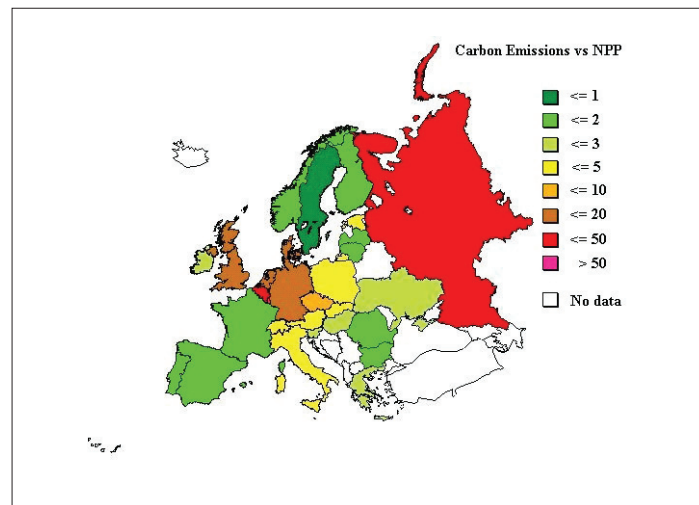

Figure 4.16 - Ratio of Net Primary Productivity (C-units) to total anthropogenic carbon emission per country for Europe in 1997. (Courtesy VITO-TAP).



## Global Change Impact on Ecosystems

### 4.2.5 Can changes in land use and land management increase carbon sequestration?

Sequestration of carbon in soils and vegetation can contribute to reaching a country's greenhouse gas emission reduction target under the Kyoto Protocol (article 3.3) and the subsequent COPs. The SOC pool is in general large and, in many cases, it even exceeds the amount of C in living vegetation. The SOC pool responds to land use conversions and changes in land management. Generally, the decline of SOC upon cultivation of land under forest or grassland is attributed to reduced inputs of organic matter, to differences in decomposition rates between crop residues and litter produced by natural vegetation, and to tillage effects (for example, increased aeration and decreased physical protection of organic matter). Two Belgian case studies carried out by the UCL-GEOG demonstrate the order of magnitude of C sequestration as a result of land use and land management change: (i) C sequestration in SOC of the Ardennes as a result of land use change between 1773 and 1973 and (ii) the C sequestration potential of improved cropland management in Belgium by 2010.

The evolution of SOC as a result of land use change in the Belgian Ardennes was calculated from SOC densities in the 0-30 cm topsoil for soil-land cover classes and their aerial extent. The SOC data were extracted from a geo-referenced soil profile database dating from the period 1950-1970. It was assumed that these SOC data represent

steady-state conditions for each type of land use. The historical distribution of the soil-land cover classes was derived from an overlay of a digital soil association map and a time series (1775-1973) of topographical maps (see Figure 4.17). Within the well-drained soils typical of about 95% of the area, we could distinguish three groups of land covers with significantly different SOC densities: (i) deciduous, coniferous, and mixed forest ( $90.2 \pm 2.0$  ton C/ha), (ii) grassland and arable land ( $81.6 \pm 2.5$  ton C/ha), and (iii) heath land ( $63.7 \pm 15.7$  ton C/ha). No significant differences between land cover classes were found as regards the wet soils of valleys ( $105.4 \pm 8.7$  ton C/ha), whereas organic soils were restricted to the peat bogs with the highest SOC densities ( $309.4 \pm 29.9$  ton C/ha). Reclamation of heath land from 1775 to 1923 resulted in a 28.1% increase in SOC upon conversion to arable land and a 41.6% increase upon conversion to deciduous forest. However, no response of SOC was observed

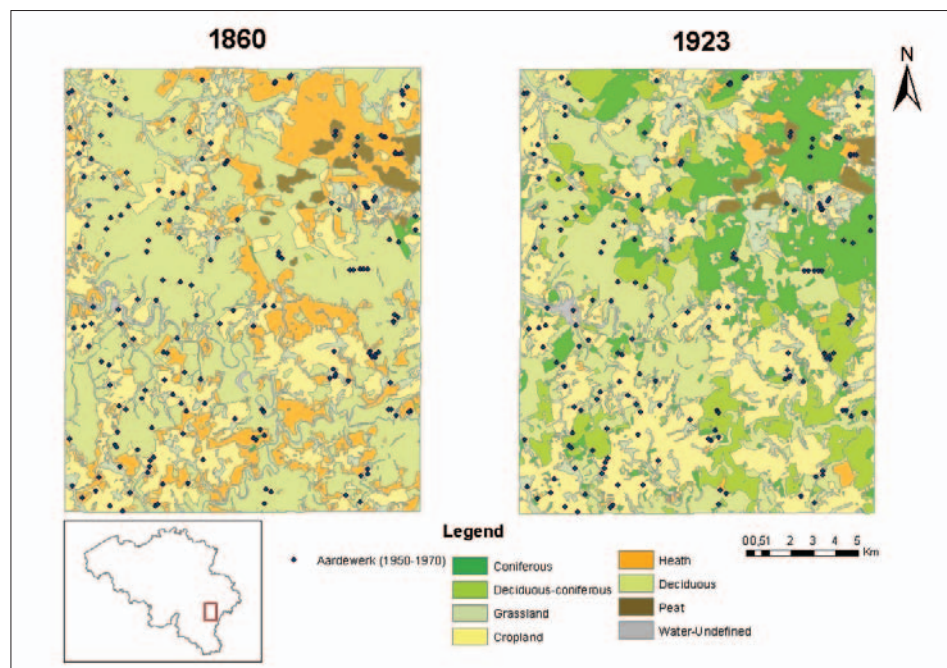

Figure 4.17 - Historical land use change in the Belgian Ardennes. The soil profiles used for the calculation of the SOC stocks in the different land use types are indicated. (B. Van Wesemael, UCL-GEOG).

from the more recent conversions of arable land to grassland and deciduous forest to coniferous plantations. Since the intensity of these conversions peaked between 1923 and 1953, the steady-state SOC levels for these more recently converted land cover classes were probably not reached at the time of soil sampling (1950-1970). Due to land use changes between 1775 and 1975, C sequestration in the soil amounts to 10.2 ton C/ha. This value is probably underestimated since only older land conversions were taken into account. Compared to the annual C sequestration in forest biomass calculated from the net ecosystem production of Belgian forests (5.0 ton C/ha/yr) the accumulation of SOC as a result of land use change is a slow process with an annual increase of 0.05 ton C/ha/yr.

The most promising C sequestration measures applicable in Belgium before the end of the first commitment period of the Kyoto Protocol are (in decreasing order of importance): (i) additional use of bio-energy crops, (ii) spreading of farmyard manure (formerly applied to grasslands) exclusively on arable land, (iii) woodland regeneration, (iv) adopting no-till farming on suitable soils over a period of 20 years, (v) the use of cover crops in the rotation following winter cereals, and (vi) organic farming. Existing and foreseen environmental regulations and strict planning policies restrict the areas on which such C sequestration measures can be applied in Belgium. For instance, the spreading of farmyard manure exclusively on arable land is not a realistic option in Flanders, where excess production of animal waste exists and therefore manure has to be spread to its maximum amounts on both arable land and grassland. C sequestration rates for the different measures are taken from long-term European experiments. Applying these rates within the Belgian context results in a C sequestration potential of 180-320 kton C/yr. This potential corresponds to

0.5-0.8% of Belgium's 1990 greenhouse gas emissions (in CO<sub>2</sub> equivalents).

#### **4.2.6 Are Belgian forest ecosystems subjected to soil acidification due to excessive deposition of nitrogen from the atmosphere?**

Nutrient enrichment of the environment, especially in nitrogen (N) and due to human activities, creates a problem for several regions in Belgium. This enrichment causes severe disturbances of ecological processes such as the biogeochemical cycles occurring between the soil, water, and air compartments of the ecosystem. Enrichment is a major threat for semi-natural or natural ecosystems where, in the case of a non-polluted environment, limited nitrogen availability strongly regulates competition between plant species. Acidification of the soil thus results from the atmospheric deposition of, primarily, sulphur (S) and nitrogen compounds. These compounds originate in industrial activity, which produces emissions of SO<sub>2</sub> (sulphur dioxide), NO<sub>x</sub> (total nitrogen oxides), and NH<sub>3</sub> (ammonia) gases. The first two can be transported over very long distances through the air, depending on the spatial scale of the industrial activity. Acidification is also linked to the dominant wind direction. Ammonia, however, seems to be produced more locally by point sources, so that it usually acts on a more restricted scale. This means that regional factors of the landscape, such as the type and roughness of the underlying surface, will also regulate the deposition rate. Nitrification is an acidifying process, as for each mole of NH<sub>4</sub><sup>+</sup> (ammonium) oxidised, 2 moles of H<sup>+</sup> (hydrogen) are produced. Yet in natural ecosystems, net H<sup>+</sup> production is assumed to be balanced, because ammonification and plant or microbial uptake consume excess H<sup>+</sup>. If leaching (the loss of NO<sub>3</sub><sup>-</sup> towards the groundwater table) occurs, then nitrification of N derived from atmospheric

## Global Change Impact on Ecosystems

deposition or internal mineralisation of soil organic N has a strong acidifying effect.

In order to assess whether acidification takes place in ecosystems or not, the 'Critical Loads' approach has been developed in the framework of the International Co-operative Programme on Assessment and Monitoring of Air Pollution Effects on Forests (ICP Forests) operating under the United Nations Economic Commission for Europe (UNECE) Convention on Long Range Transboundary Air Pollution (CLRTAP). A critical load can be defined according to present knowledge as 'the maximum deposition of a given compound that will not cause long-term harmful effects on ecosystem structure and function'. Table 4.3 gives the critical loads for N-deposition on coniferous and deciduous forest ecosystems. Data are shown for forest ecosystems in

Flanders, together with effects on these ecosystems. The lowest values are the critical loads for long-term deposition while the highest values are typical of short time periods. The BELFOR project (Belgian Forest Ecosystems) has determined atmospheric N-deposition in five experimental forest ecosystems distributed over the Flemish and Walloon regions. Information was also collected on the storage of nitrogen in the above- and below-ground biomass and on N-losses through percolation towards the groundwater table. These measurements were part of a more detailed analysis of the nitrogen cycle in terms of fluxes (transport) and pools (storage) in different ecosystem compartments. Table 4.4 gives a sample of the data obtained for mixed deciduous and coniferous forests located in the northern and southern parts of Belgium. It seems that the long-term critical loads are

Table 4.3 - Critical nitrogen loads for different forest ecosystems in Flanders (Belgium), including effects on the ecosystem when the critical load is exceeded (according to Vanongeval et al. 1998).

Ecosystem	Critical N-loads (kg/ha/yr)	Effect after critical load is exceeded
Coniferous forest	7-20	Decline of terrestrial lichens and ectomycorrhizae, increase of nitrogen-loving tree species
	13-21	Nitrate pollution of groundwater
	21-42	Increased sensitivity to frost and diseases
	17-70	Disturbance of nutrient uptake
Deciduous forest	11-20	Decline of terrestrial lichens and ectomycorrhizae, increase of nitrogen-loving tree species
	24-41	Nitrate pollution of groundwater

Table 4.4 - Nitrogen fluxes (kg/ha/yr) by atmospheric deposition and percolation to the groundwater for Belgian forest ecosystems studied within the scope of the BELFOR project (Belgian Forest Ecosystems). Nitrogen storage (kg/ha) in the biomass of stems and branches is also listed for comparison. Data are valid for 1998 (BELFOR project report).

Location in Belgium	Forest type	Atmospheric deposition (kg/ha/yr)	Percolation (kg/ha/yr)	Aboveground storage (kg/ha/yr)
Gontrode	Deciduous	23.0	24.7	589
Brasschaat	Coniferous	32.3	26.9	239
Vielsalm	Deciduous	9.3	3.4	212
Vielsalm	Coniferous	16.9	2.3	169
Waroneu	Coniferous	9.7	3.9	-

exceeded in the Flemish experimental forests at Gontrode (mixed deciduous) and Brasschaat (coniferous). For the Brasschaat forest, this was explained in terms of a disturbance of nutrient uptake, indicated by the assessment of tree nutritive status based on foliar diagnostics. In the Gontrode forest, current N-deposition loads are on the edge of exceeding the critical load for nitrate pollution of the groundwater. This is also supported by the high amounts of nitrate leaching to the groundwater (see Table 4.4). In the literature, critical loads for forests in Wallonia are calculated, and it is demonstrated that it is important to use site-specific data for critical load calculations. Applying this technique to the Waroneu forest (coniferous), investigators determined a critical N-load of 7 kg/ha/yr. Hence, the current atmospheric nitrogen deposition at Waroneu exceeds the critical load. For managed coniferous forests, however, a smaller critical N-load of 3.8 kg/ha/yr was calculated. Atmospheric nitrogen deposition in the Vielsalm coniferous forest strongly exceeds this range of critical N-loads (3.8 to 7 kg/ha/yr). Critical loads for temperate broadleaved forests range between 9.4 and 21.7 kg/ha/yr. Nitrogen depositions in the Vielsalm deciduous forest are at the very edge of this range, which means that atmospheric deposition at Vielsalm – if it remains stable or decreases – is not a real threat for this forest ecosystem. In conclusion, the answer to the question formulated above is that excessive nitrogen deposition is a problem for forest ecosystems in the northern parts of Belgium. A number of micro-organisms at soil level might decline because of acidification, the relative abundance of nitrogen-loving plant species might increase, and nitrogen pollution of the groundwater is probable. The problem of excessive deposition is less serious in the southern regions for deciduous forest ecosystems, although the coniferous forests there might be in danger as well. The BELFOR

data also reveal that coniferous forests display higher deposition rates than deciduous ones. The enhancement of turbulence, caused by the aerodynamically rough crowns of coniferous trees, might explain this discrepancy.

#### **4.2.7 How will the carbon sink of Belgian forests evolve over the 21st century? What are the impacts of climate and CO<sub>2</sub> in this respect?**

At the end of the 21<sup>st</sup> century, the atmospheric CO<sub>2</sub> concentration is projected to reach 550 to 1,000 ppmv, depending on the socio-economic scenario adopted for the future (IPCC, 2001). This represents on the average a two-fold increase with respect to the current concentration of ~370 ppmv. Over the same period, climate models predict a rise in the global temperature of 1.4-5.8 °C in response to this increase in CO<sub>2</sub> and other greenhouse gases. In Belgium, the temperature is expected to increase by 2-4 °C. This temperature rise will be accompanied by a worldwide redistribution of precipitations, both spatially and seasonally. In our regions, a trend towards higher precipitation levels is expected in winter, and no change to a slight drying is projected for the summer period.

Forest ecosystems will be strongly affected by these CO<sub>2</sub>, temperature, and precipitation changes. The magnitude of the impacts is difficult to evaluate and this can be done only through the use of process models describing the energy, water, carbon, and nutrient budgets of forest ecosystems. Within the BELFOR project, ULg-LPAP has developed such a model, called ASPECTS (Atmosphere-Soil-Plant Exchange of Carbon in Temperate Sylvae). This model has been tested on various forest sites in Belgium, and notably on the Brasschaat and Vielsalm experimental stations which measure the net exchange flux of CO<sub>2</sub> between the atmosphere and the ecosystem (NEE – Net

## Global Change Impact on Ecosystems

Ecosystem Exchange) with eddy covariance systems. These two experimental stations are respectively managed by UA-PLECO and FUSAGx-ECOPHYS. The model has been able to reproduce NEE measurements carried out at these two sites in 1998.

Temperature changes over the 20<sup>th</sup> and 21<sup>st</sup> centuries in Brasschaat and Vielsalm are illustrated in Figure 4.18, together with the increase in atmospheric CO<sub>2</sub> over the same period. The impacts of these CO<sub>2</sub> and climate changes on forest ecosystems at both sites (Scots pines in Brasschaat and beech trees in Vielsalm) have been evaluated with the ASPECTS model, by comparing a forest planted

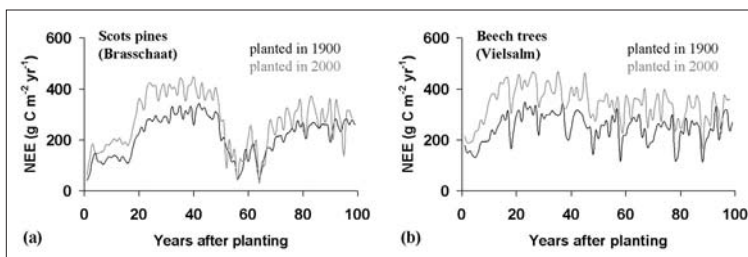

Figure 4.19 - Model evolution of carbon sequestration (NEE, Net Ecosystem Exchange) as a function of forest age for the Scots pine and beech plots located at the experimental sites of Brasschaat and Vielsalm (Belgium). In both cases, the evolution of a 20<sup>th</sup> century forest (planted in 1900) is compared to that of a 21<sup>st</sup> century forest (planted in 2000). Management practices are assumed to be the same in both centuries. (L. Francois, ULg-LPAP)

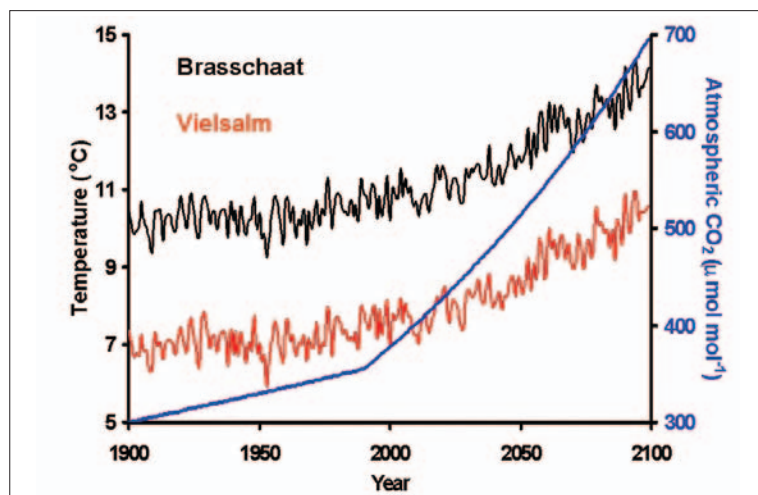

Figure 4.18 - Evolution of atmospheric CO<sub>2</sub> over the period 1900-2100 according to scenario IS92a of IPCC 1995 and temperature rise at Brasschaat and Vielsalm (Belgium) experimental sites over the same period, evaluated on the basis of a climatic scenario from the Canadian Coupled General Circulation Model, CGCM. (L. François, ULg-LPAP).

in 2000 with the same forest planted in 1900. The same management histories have been assumed in both calculations. Forest carbon sequestration (i.e., NEE fluxes) will increase under 21<sup>st</sup> century conditions (Figure 4.19). In addition, ASPECTS simulations indicate that the

net amount of CO<sub>2</sub> sequestered in any given year will depend on: (i) forest age, with maximum sequestration between ages 20 and 40, (ii) annual weather conditions, with large variations from year to year, and (iii) forest management. For instance, substantial forest clearing happens near age 50 in Brasschaat. As a result, forest productivity is strongly reduced between ages 50 and 70 and, for

this age range, the 21<sup>st</sup>-century forest does not sequester any more carbon than the 20<sup>th</sup>-century forest.

The overall increase in forest carbon sequestration in the 21<sup>st</sup> century is the net result of (i) higher photosynthetic rates (i.e., a carbon sink for the atmosphere) due to both elevated atmospheric CO<sub>2</sub> levels (CO<sub>2</sub> fertilisation) and a lengthening of the growing season, and (ii) higher autotrophic and heterotrophic respiration rates (i.e., a carbon source for the atmosphere) associated with the warmer climate.

## 4.3 What is the impact of global change on ecosystem structure, functioning, and distribution (impacts other than carbon sequestration)?

### 4.3.1 Are elevated CO<sub>2</sub> and climate warming changing the productivity of Belgian ecosystems (grasslands)?

By the early 1990s, rising concentrations of atmospheric CO<sub>2</sub> (and other greenhouse gases) and the coinciding increases in air temperature were well recognised as global change factors (UNFCCC), but their effects on ecosystems had rarely been studied together. CO<sub>2</sub> and temperature both affect the uptake of C by plants, through their effects on photosynthesis and respiration, and from a biochemical and physiological perspective there are several pathways for interaction. However, these pathways are known mainly from short-term responses, so the question arises as to how elevated CO<sub>2</sub> and temperature increase affect plant communities when they both become part of the background environment, as will be the case a few decades from now. Grassland was chosen as a model to answer these questions, in view of its economic importance in Belgian agriculture.

Experiments by UA-PLECO and UGent-PP have demonstrated that long-term exposure to elevated CO<sub>2</sub> affects grassland species considerably with respect to productivity and functioning. Many physiological and morphological characteristics are modified both directly and indirectly. Stimulation of leaf and canopy photosynthesis is reported for perennial ryegrass, a dominant species of heavily managed grasslands, and for many other species as well. As a consequence of stomata closure, grasses grown at elevated CO<sub>2</sub> concentration frequently exhibit decreased water use. A reduction in tissue nitrogen content

and increased starch levels are phenomena associated with the thicker and/or denser leaves developed by plants growing at high CO<sub>2</sub>. This alters fodder quality. Other shifts in allocation patterns include increased root/shoot ratios, changes in branching and height, increased leaf area.

Temperature increase has equally drastic consequences. Its influence can mainly be attributed to changes in the rate of biochemical processes that control nutrient uptake and conversion and growth. A warmer environment increases the frequency of conditions that exceed the optimum temperature range, and temperature effects are likely to be more variable than CO<sub>2</sub> effects because optimum temperatures differ between plant species. UA-PLECO and UGent-PP examined in particular the combined effects of a long-term increase in atmospheric CO<sub>2</sub> concentration and air temperature in a selection of economically important, cool-temperate grass species (*Lolium perenne* L. cv. Vigor, *Lolium perenne* L. cv. Condesa, *Lolium multiflorum* Lam. cv. Lemtal, *Festuca arundinacea* Schreb. cv. Barcel, *Phleum pratense* L. cv. Erecta, and *Poa trivialis* L. cv. Dasas). In a first phase, this group of species was screened for a range of functional and structural characteristics, with emphasis on productivity. The main objective was to assess the risks and opportunities associated with future climatic conditions for the ecological and agricultural functions of grassland. This required the construction of a realistic system for exposing grassland ecosystems to different CO<sub>2</sub> concentrations and air temperature regimes, all other microclimatic factors being as close to field conditions as possible. When grass species were grown in monoculture in loamy sand, supplied with ample nutrients and water, and regularly clipped to simulate mowing, elevated CO<sub>2</sub> significantly increased aboveground productivity, the effect ranging

# Global Change Impact on Ecosystems

between 11.2 and 25.9% on a seasonal basis. The effect of increased air temperature, on the other hand, was slightly negative (range -1.3 to -7.5%, except in *Lolium perenne* L. cv. Vigor). No significant interactions were observed between the CO<sub>2</sub> and temperature regimes, so the CO<sub>2</sub> and temperature effects were additive. The temperature effect alone was positive in spring but reversed during the season, to become a severe stress with detrimental consequences for productivity in summer (see Figure 4.20). The present-day spring-summer amplitude is therefore expected to increase (higher spring productivity and lower summer productivity). This is likely to have negative consequences for agricultural practice, because in the present-day climate, grasses are already in short supply as fodder input for animal husbandry in summer, owing to a variety of growth-depressing factors (water shortage, phenological stage, and physiology). As rising temperatures are expected to depress summer productivity even further, this may increase agricultural costs as grasses have a high energy content and a low cost as compared to concentrates. If increased air temperature stems mainly from rising CO<sub>2</sub> levels, part of these negative effects will be eliminated by the stimulatory effect of rising CO<sub>2</sub> itself. Because greenhouse gases other than CO<sub>2</sub> will not mitigate the effects of a warmer climate in a similar fashion, it can be assumed that preferential reduction of emissions of other greenhouse gases will alleviate the problem. It should be emphasised, however, that this constitutes only one element to be taken into account in decision-making on greenhouse gas reduction strategies (the cost of specific emission reduction, for example, is not part of this analysis).

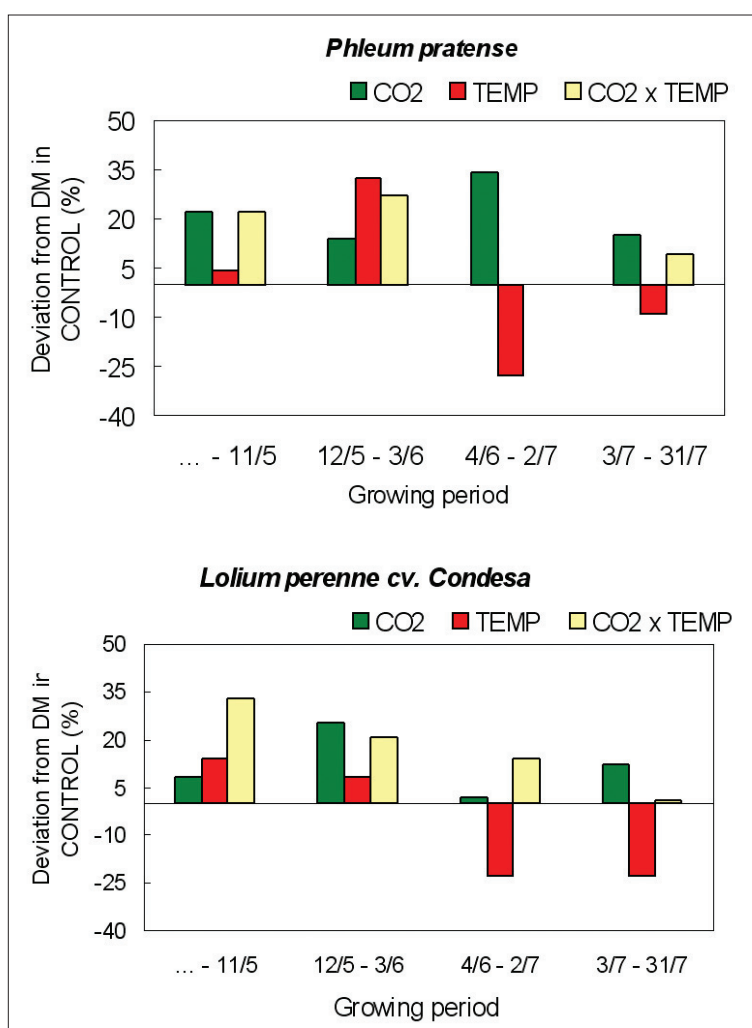

Figure 4.20 - Changes in aboveground harvestable dry matter (DM) production (%), resulting from elevated CO<sub>2</sub> concentration (CO<sub>2</sub>, 700 ppm), elevated air temperature (TEMP, ambient +4°C), and both of these global changes combined (CO<sub>2</sub> × TEMP), in 2 grass species during 4 growing periods in 1992 (base = CONTROL). Growing periods before 12 May are combined because of unequal duration. Note the reversal of the temperature effect from spring (positive influence) to summer (negative influence). (I. Nijs and L. Van Peer, UA-PLECO).

## 4.3.2 Can we control effects of elevated CO<sub>2</sub> and climate warming on grasslands by adjusting management practices?

Restricted nutrient availability is reported to limit the potential of plants to respond to elevated CO<sub>2</sub>. In the grass species referred to in the previous section, this is not the case because,

although nutrient availability to the stand strongly determines productivity, it does not modify the relative CO<sub>2</sub>-stimulation of aboveground production. This means that elevated CO<sub>2</sub> stimulates productivity in grassland systems with both a low and a high nutrient input. On the other hand, nutrient availability does affect the negative response of grassland to increased air temperature in the sense that part of the production loss can be prevented by lowering the nitrogen input. Unfortunately these responses do not provide a means of limiting temperature damage (particularly in summer), because lower nitrogen inputs themselves reduce productivity more than they reduce high temperature damage. Concerning risk assessment in managed systems with high nitrogen fertilisation, it is clear that high temperature is a larger risk factor than elevated levels of CO<sub>2</sub>, because the main substantial negative effect of the latter is a lower quality of the plant material though a lower nitrogen content, which may affect animal production. Apart from this, elevated CO<sub>2</sub> levels are mainly beneficial. Also from this standpoint (see Section 4.3.1), reduction of greenhouse gas emissions other than CO<sub>2</sub> (methane, CFCs, nitrous oxides) would seem a higher priority than preventing the further rise of the CO<sub>2</sub> level itself, because in this way part of the temperature rise can be prevented (the consequences of such a rise being more detrimental than those of CO<sub>2</sub> itself).

In well-fertilised managed grassland, a further increase in nitrogen inputs does not provide a means of enhancing CO<sub>2</sub>-stimulation, at least not on a relative basis. On the other hand, some reduction of nitrogen input is possible under elevated CO<sub>2</sub> levels without loss of productivity as compared to present-day CO<sub>2</sub> levels (CO<sub>2</sub>-stimulation will compensate for the loss due to lower nitrogen input). The above-mentioned reduced quality of

the plant material should be taken into account, though. It remains to be tested whether these findings for grass cultivars can be extrapolated to natural grasslands or to other extensively managed systems with low nutrient input. In general, the consequences of elevated CO<sub>2</sub> levels and climate warming are relatively species-independent in temperate grasses, as far as the direction of the change (positive or negative) is concerned. In the representative selection of western European grasses referred to above, the magnitude of the changes, on the other hand, did vary with plant species identity, e.g., CO<sub>2</sub>-stimulation of harvestable production ranged from +11 to +26%. Most of the species in this group were susceptible to higher temperatures in summer, although some showed hardly any effect (reductions in productivity ranged from 0-30%). This opens prospects for selecting species that are more suitable for a warmer climate in agriculturally managed, sown grasslands.

### **4.3.3 What impacts will climate change have on the distribution of vegetation worldwide? How will these changes interfere with carbon sequestration?**

Changes in climate and CO<sub>2</sub> levels will affect not only vegetation functioning, but also vegetation structure and, on the largest spatial scale, even global vegetation distribution. This is already obvious today in regions such as the Mediterranean, where a trend towards aridity is currently observed in response to climate and land use change. Models have been developed to describe the response of global vegetation to climate change. These models group plant species into functional types according to common characteristics in terms of phenology (deciduous, evergreen), height (trees, bushes, grasses), leaf type (broad-leaved, needle-leaved), ... For convenience, assemblages of plant functional types are classified as biomes, a



## Global Change Impact on Ecosystems

useful concept for describing global vegetation. Examples of biome units are: tropical rainforest, savannah, tundra, temperate deciduous forest, desert or semi-desert, ... What are the to be expected changes in the distribution of world biomes in the future?

Figure 4.21 shows the present (1990-1999 climate) and future (2090-2099 climate)

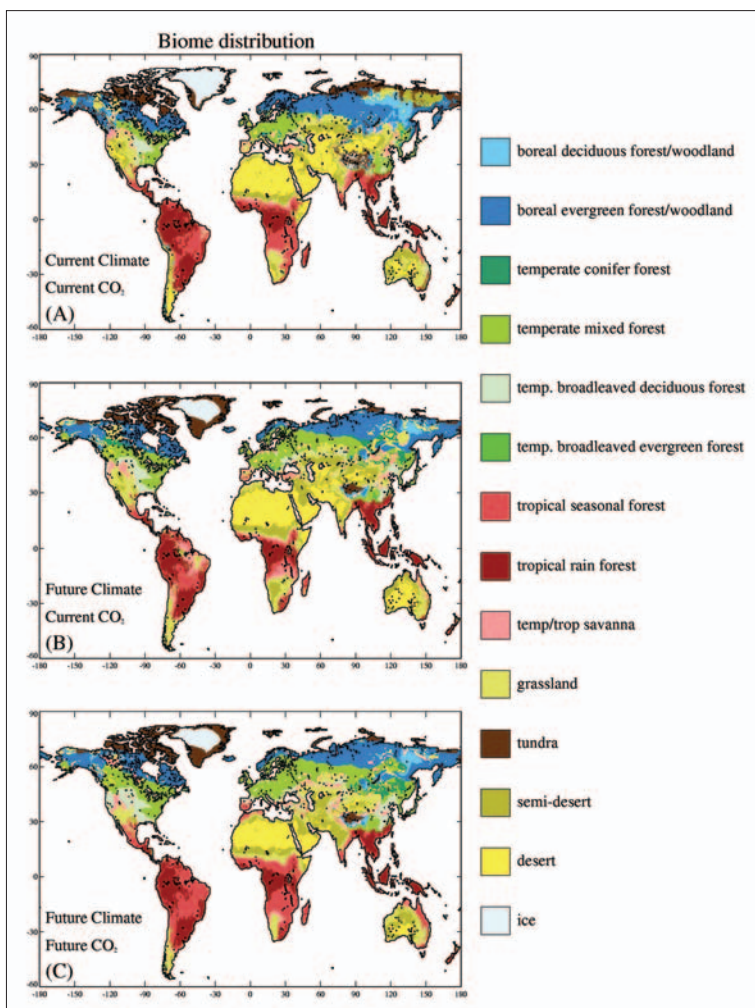

Figure 4.21 - Geographical distribution of major world biomes (natural vegetation) calculated with the CARAIB (Carbon Assimilation In the Biosphere) vegetation model developed by ULg-LPAP. The model shows the separate impacts on vegetation of future changes in climate (temperature, precipitation) and atmospheric CO<sub>2</sub>: (A) standard simulation with current climate and current CO<sub>2</sub>, (B) simulation with future climate and current CO<sub>2</sub>, and (C) simulation with future climate and future CO<sub>2</sub>. 'Current' refers to the period 1990-1999 and 'future' to 2090-2099. (L. François, ULg-LPAP).

distributions of world biomes calculated with the CARAIB model (Carbon Assimilation In the Biosphere) developed by ULg-LPAP. The impacts of climate (temperature, precipitation) and CO<sub>2</sub> changes are separated by running vegetation model simulations for climate change only and for the combined climate and CO<sub>2</sub> changes expected for the end of the 21<sup>st</sup> century

relative to the present. Climate change will result in a substantial reduction of the areal extent of tundra in the boreal zone and also in a marked northward shift of the boundary between temperate mixed forests and boreal evergreen forests (taiga). At lower latitudes, an increase of the desert/semi-desert areas can be expected in southern Africa, the Mediterranean region, India, and Australia. When both climate and CO<sub>2</sub> changes are taken into account, the trend towards larger desert/semi-desert areas is strongly reduced or even absent, because vegetation transpiration is reduced under higher CO<sub>2</sub> levels. These results illustrate the response of natural vegetation. In densely populated regions, human-induced changes associated with ecosystem management will superimpose on these natural changes. It can be

expected that vegetation changes will affect C sequestration in the future, but the magnitude of this effect is not yet known. Plant species with narrow bioclimatic tolerance are threatened under rapidly changing climatic conditions and may disappear unless adequate management strategies are developed. If these species are not replaced rapidly by other species better adapted to the new climate, vegetation productivity will be temporarily reduced in these

regions, without a corresponding reduction in soil heterotrophic respiration. As a result, C sequestration will be temporarily reduced in such regions or even transformed into a net C release into the atmosphere. Such interference between vegetation dynamics and CO<sub>2</sub> sequestration is poorly known and very difficult to predict for the future.

## 4.4 What is the impact of global change on water resources?

### 4.4.1 What are the possible impacts on the hydrology of Belgian basins? Are some hydrological basins more sensitive than others?

Water is becoming an increasingly valuable commodity, from both a quantitative and a qualitative perspective, as demonstrated by legislation at both the EU (e.g., Water Framework Directive 2000/60/EC) and UN levels (AGENDA 21, Chapter 18 on water resources). Global change scenarios predict important climate perturbations like temperature increases and modification of precipitation patterns. These changes affect the hydrological cycle of catchments by modifying the quantities of incoming water into the system and by disturbing the water-soil-plant system. The hydrological response of catchments to climate change depends on the intrinsic properties of the catchments (land use, topography, soil and sub-soil properties, ...). Here we address the question: to what extent can future changes on the scale of Belgian basins be predicted by hydrological models (see Chapter 2 for changes in the global water cycle)?

Simulations carried out under present climate conditions with the EPIC-GRID catchment hydrological model enable researchers to quantify the relative importance of different flows: lateral flows (surface, fast and slow subsurface flows) and groundwater

recharge. This distinction between fluxes, made possible via a detailed representation of the unsaturated zone up to the groundwater table, makes it possible to know the contribution of each flow to the river stream flow. Figure 4.22 (black numbers) shows the partitioning of water among the produced fluxes for some Belgian basins. We can note the importance of groundwater recharge for basins such as the Gete or the Jeker: in these basins, base flow represents an important part of the river stream flow. For basins with more impermeable sub-soil, groundwater recharge is lesser: the most important contribution to stream flow comes from the surface and lateral subsurface flows. The hydrological impacts of climate change on catchment hydrology are, therefore, different between agro-climatic regions and between Belgian basins. Figure 4.22 (red numbers) presents the simulation results of global change impacts on flow production for some Belgian basins for one climate change scenario with reduced precipitation (ECHAM4 scenario,

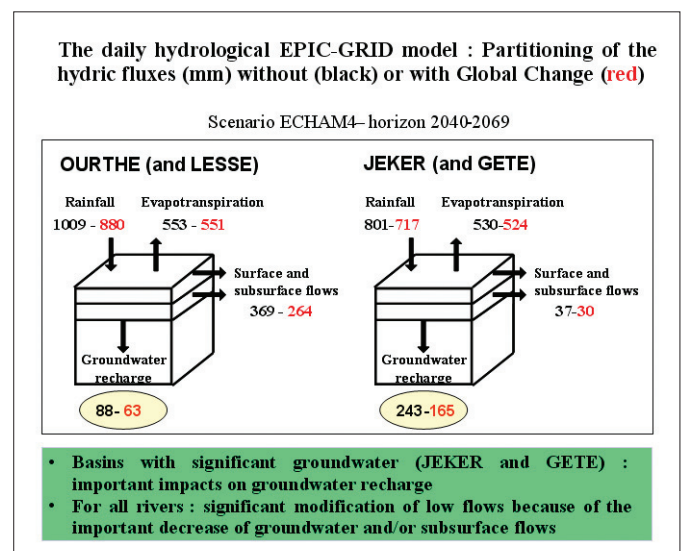

Figure 4.22 - Partitioning of flow production within basins (in Belgium) and influence of climate change on flow production (EPIC-GRID catchment hydrological model simulations, ECHAM4 climate change scenario, horizon 2040-2069). (C. Sohier and S. Dautrebande, FUSAGx-UHAGx).

## Global Change Impact on Ecosystems

horizon 2040-2069, see Section 4.4.2). For basins with significant groundwater such as the Gete or the Jeker, direct negative impacts are observed on groundwater recharge, which has indirect consequences on river low flows. In basins with no significant groundwater (for example, the Lesse or the Ourthe basin), the direct consequences are on surface and lateral subsurface flow production, which has direct impacts on the mean river flows and indirect consequences on river low flows. For all of the rivers, whether stream flow is fed mainly by subsurface flows or by groundwater flow, the result is a significant decrease of the low flows.

### 4.4.2 Will there be changes in soil moisture, groundwater levels, and stream flow?

Global change scenarios include a general temperature increase, but also some modification of other climate variables such as rainfall, as shown in Figure 4.22. These climate changes modify the hydrological cycle and have important consequences for water resources (soil moisture, groundwater recharge, water quality) and river flows. Hydrological models are a useful tool for quantifying these impacts. If the various General Circulation Models (GCMs) predict different increases in temperature, there will be more uncertainties in rainfall predictions. How are these uncertainties to be taken into account and what are the predictions?

Through the IPCC, the results of experiments conducted with seven GCMs have been made available to the scientific community. A subset of three GCMs was selected, preference being given to the models offering predictions for all the variables needed to calculate evapotranspiration. The selected models were: ECHAM4 (German Climate Research Centre), HadCM2 (UK Hadley Centre for Climate Prediction and Research), and CGCM1 (Canadian Centre for Climate

Modelling and Analysis). Figure 2.34 shows temperature and precipitation patterns predicted by these models for Belgium (scenarios elaborated by IRM / KMI on the basis of GCM results). Temperature change is positive in all climate change scenarios (about 2-4°C). For precipitation, the predictions are more variable: two of the three climate change scenarios (ECHAM4 and HadCM2) predict a decrease in annual precipitation; for CGCM1 the annual precipitation is not so different from current values. A shared tendency among scenarios, however, is rainfall decrease in summer. The hydrological simulation results (EPIC-GRID model simulations) show, for one of the three scenarios (ECHAM4), important perturbations in water flow production, with a substantial annual decrease in lateral flows (sum of surface and subsurface flows) and groundwater recharge (see Figure 4.23). For the CGCM1 scenario, the change in flow production is lesser than for the two others scenarios (not shown). In spite of the annual decrease in lateral flows, the simulations

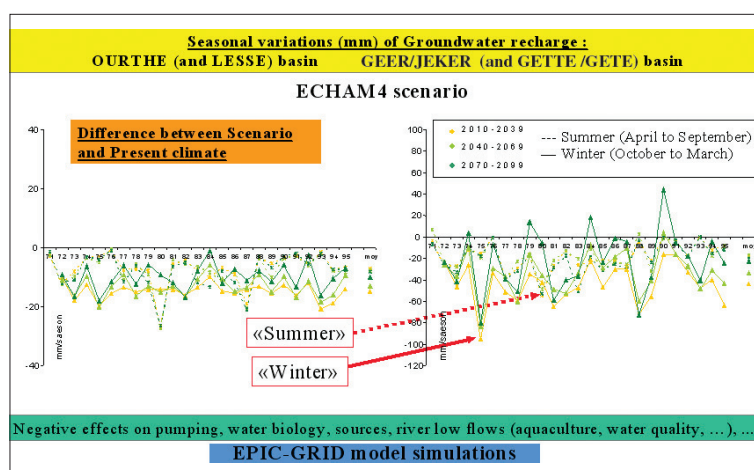

Figure 4.23 - Impacts of global change scenarios on groundwater recharge (in Belgium): annual mean and seasonal variations over a period of 24 consecutive months, relative to present conditions (base). Simulations with the EPIC-GRID catchment hydrological model. Moy denotes modelled year in the 21<sup>st</sup> century (the starting year on the X-axis is either 2010, 2040, or 2070). (C. Sohier and S. Dautrebande, FUSAGx-UHAGx).

indicate on a monthly basis an increase in these flows during some winter months. This monthly variation is strongly correlated with the monthly change in precipitation predicted by the scenarios. From one scenario to another, the deficit in groundwater recharge ranges, on an annual basis, from 1% for the most optimistic scenario to 34% for the most pessimistic one. The decrease in groundwater recharge will raise important questions such as: What about drinking water provision and irrigation water? What about wetlands? What will be the consequences of river low flows for eutrophication, water quality, river population, aquaculture, ...? Soil moisture is also affected by the climate change scenarios. The decrease of summer precipitation leads to more frequent and consequent water deficiencies, with possible negative impacts on vegetation and crops due to water stress and water needs for irrigation.

#### 4.4.3 What are the possible impacts of climate change on agricultural systems (crop water deficiencies, irrigation needs, crop growth and yield, field accessibility)?

Global change affects the hydrological cycle of catchments not only by changing quantities of incoming water into the system, but also by influencing the vegetation. The factors affecting vegetation development (growth, productivity) are temperature, water availability, and CO<sub>2</sub> concentration in the atmosphere. Temperature increases predicted by global change scenarios lead to earlier development and maturity of crops. What are the repercussions of such changes for actual evapotranspiration, and what are the subsequent consequences for agricultural production?

Climate change simulations (EPIC-GRID catchment hydrological model) show that impacts on actual evapotranspiration are not

so important at the annual time step: only a small increase is observed. However, the monthly breakdown of actual evapotranspiration is displaced: evapotranspiration increases in spring due to an earlier development of the vegetation and decreases in summer because of crop water stress and earlier crop maturity (see Figure 4.24). An increase in CO<sub>2</sub> concentration and temperature will result in increased production for most crops in Belgium. This increase, however, is crop-specific and depends strongly on soil water availability. Assuming that crop variety, disease rates, and fertilisation rates are identical to the present situation, the simulations predict a small increase in the yields of sugar beet and winter wheat. These changes, although small when expressed as a long-term averaged value, are subject to great interannual variability as a result of annual climatic conditions, including possible yearly reductions. Although most crops have higher water use efficiencies in a CO<sub>2</sub>-enriched atmosphere, severe droughts may affect productivity. Climate change scenarios assume that future climate will be affected

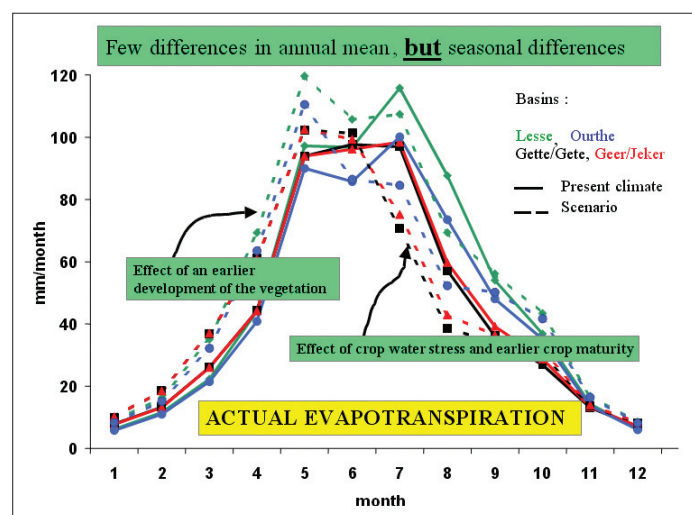

Figure 4.24 - Monthly evolution of crop actual evapotranspiration under present climate and climate change scenarios for four different river basins. (EPIC-GRID catchment hydrological model simulations by C. Sohier and S. Dautrebande, FUSAGx-UHAGx).

## Global Change Impact on Ecosystems

by a summer rainfall decrease. This leads to important modifications of soil moisture evolution. Simulation results indicate the crop water deficiency periods and their frequency (see Figure 4.25): appreciably increased water deficiencies during the vegetation period will increase irrigation needs. An increase in the critical ten-day deficiency (between 10 July and 10 August) is general and indicates enhanced drought, requiring increased irrigation volumes in order to satisfy needs. For sensitive crops such as vegetables, irrigation needs will be greater than today whilst resources will decrease. Another important Belgian activity likely to be affected by global change is animal husbandry, because of the combined effect of increased soil water deficiencies on pasture production (the vegetation is already drought-sensitive in the present climate) and the increased drinking water need of livestock. Climate change simulations have also shown that farm work will probably be affected: whereas periods

of field inaccessibility should become shorter (essentially in spring with the advantage of an earlier beginning of farm work), periods with a risk of soil compaction and problems of root and tuber extraction will become more important.

### 4.4.4 How sensitive are diverse fen ecosystems to changes in hydrology coinciding with a changing climate?

Hydrology plays a central role in the functioning of wetlands: a permanently high groundwater level and base saturation and low primary production are characteristic system properties, directly influenced by hydrological relations between the system and its surroundings. Recent research has revealed that wetland soil chemistry is much more dynamic than previously thought. During dry summer periods, groundwater levels drop. This immediately induces acidification of the peat soil, possibly associated with increased phosphorus (P) availability. It is believed that this process is of key importance in evaluating

climate change effects on fen ecosystems. Hence, researchers examined the sensitivity of three fen sites (Belgium: Torfbroek, province of Brabant, and Marais de Vance, province of Luxemburg; UK: Buxton Heath, Norfolk) to changes in groundwater level (see Section 4.4) that might be expected in a future climate.

To characterise the acidification process, a soil column technique was used: in

some soil columns extracted from the locations referred to above, the groundwater table was maintained near the surface, while in others the water level was gradually reduced to a depth of 20 cm below the soil surface. The onset of low water levels induced in the soils of the different sites a similar reaction. Drought treatment induced in the Buitengoor and the

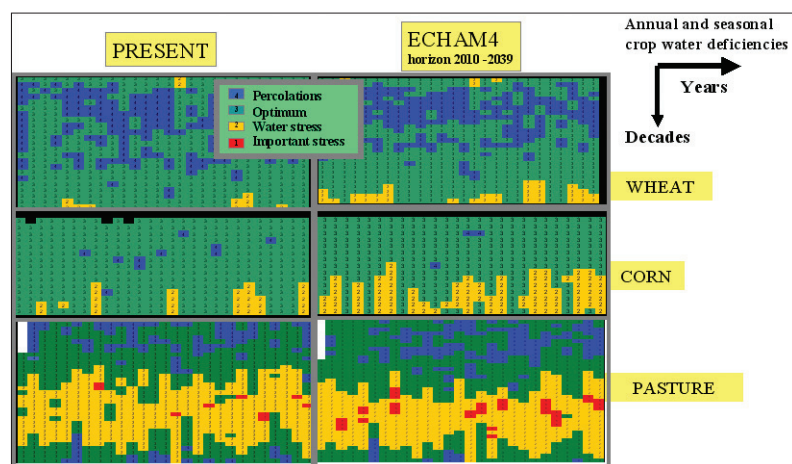

Figure 4.25 - Crop water deficiencies in three different crops under present climate (left) and climate change scenarios (right), in each case for a period of 30 years (EPIC-GRID catchment hydrological model simulations, climate change scenario ECHAM4). Interannual variability (differences between years) is expressed on the horizontal axis, intra-annual variation (differences between decades within the year) on the vertical axis. (C. Sohier and S. Dautrebande, FUSAGx-UHAGx).

Buxton Heath columns an increase in acidity (i.e. a lowering of the pH) and a decrease in bicarbonate ( $\text{HCO}_3^-$ ). In Marais de Vance, the pH remained stable and  $\text{HCO}_3^-$  decreased. Drought also caused a significant increase in redox potential (i.e. the soil was oxidised) and in the sulphate ( $\text{SO}_4^{2-}$ ), calcium (Ca) and magnesium (Mg) concentrations. In all three study terrains, the iron (Fe) and manganese (Mn) contents decreased immediately after lowering of the groundwater table, reaching almost zero within one week of drainage. Between the three study areas, there were differences in the intensity and occurrence of the drought response (see Figure 4.26), some ion concentrations changing rapidly and others slowly. From these experiments, it was concluded that short drought events can induce acidification, and that the intensity of the process depends on physical and chemical

soil characteristics (e.g., moisture retention capacity, acid neutralising capacity, ...).

In follow-up experiments, a survey across western European rich fens was conducted. In this global change study deviating from the classical approach (impact of atmospheric drivers on individuals or monocultures), the relation between drought-induced acidification and different soil physical and chemical parameters was determined at different fen sites across Belgium, the Netherlands, and the UK. Acidification of the different soils was induced in a small column experiment during a 10-week drought. On the basis of the vegetation, four groups could be recognised within the set of sites. The sites in one group were transitional towards intermediate fens; a second group was characterised by the presence of rich-fen plant species and by plant species (e.g., *Carex hostiana*) indicative of the presence of a calcareous substrate or a calcareous groundwater supply. The fen sites of group three contained many poor-fen plant species. The fourth group contained many species revealing a wet-meadow character. Temporary drought had a significant effect on different soil parameters. At nearly all study sites, acidification of the soil environment occurred after a period of drought (see Figure 4.27). Temporary lowering of the groundwater table did not seem to influence the Fe and aluminium (Al) concentrations or the amount of chlorine (Cl). This last fact indicates that differences measured for the other chemical parameters cannot be explained by a dilution effect. Table 4.5 shows the Pearson coefficients for the correlations between different soil parameters and the severity of acidification, expressed by the difference between the end and initial soil pH and by the  $\text{SO}_4^{2-}$  concentration. An increasing negative pH difference and an increasing  $\text{SO}_4^{2-}$  concentration indicate increasing acidification. For both, a negative correlation was found with

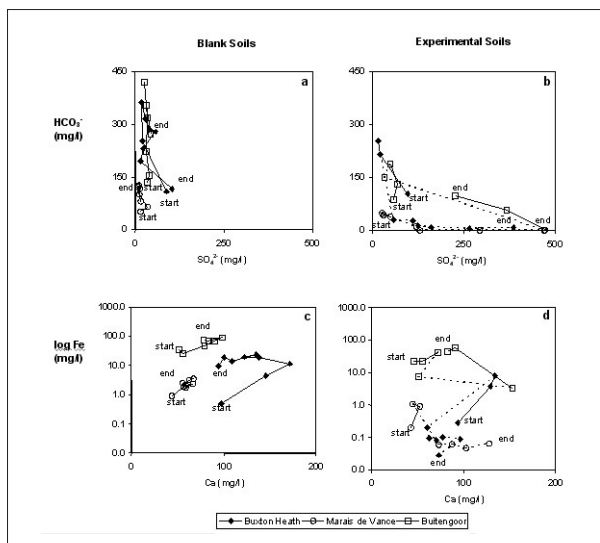

Figure 4.26 -  $\text{HCO}_3^-$  (bicarbonate),  $\text{SO}_4^{2-}$  (sulphate), Fe (iron,) and Ca (calcium) concentrations in soil solution from control and experimental soil columns from Buxton Heath - UK, Marais de Vance and Buitengoor - Belgium

(--- = period of low groundwater level; — = period of high groundwater level).

In the experimental columns, the groundwater table was reduced to simulate changes in hydrology that coincide with a warmer climate. (V. Van Haesebroeck, D. Boeye and P. Meire, UA-ECOBÉ).

## Global Change Impact on Ecosystems

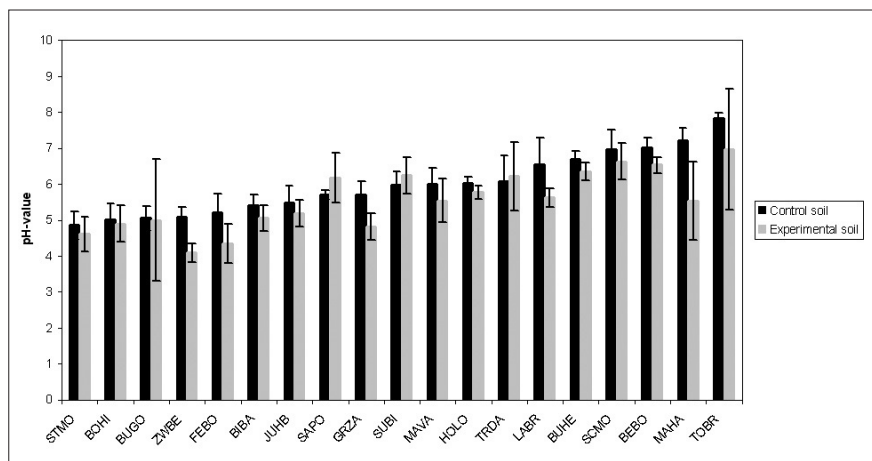

Figure 4.27 - Soil pH in control and experimental (exposed to drought) soil from different rich fen sites across Europe. Values are means of 5 replicates. (V. Haesebrouck and P. Meire, UA-ECOBÉ).

the original soil pH and a positive correlation with the initial  $\text{SO}_4^{2-}$  concentration. Striking is the negative correlation of both with the  $\text{Ca}^{2+}$  concentration. The pH difference also showed a negative correlation with Fe, Mg, and P. Important to mention is the positive correlation of the pH difference with the cation exchange capacity (CEC) and the sum of bases (S). The results of these experiments show that at all sites a drought response similar to that found for Buitengoor took place. Drought caused acidification of the soil environment and induced increased solubility of cations ( $\text{Ca}^{2+}$ ,  $\text{Mg}^{2+}$ ) and of

Fe and Mn. However, the various rich fens showed differences as regards the time and depth of the effect. The extent to which drought sensitivity was expressed depended on the physical and chemical soil characteristics (texture, CEC, and base saturation). It became clear that areas with a

low acid neutralising capacity are particularly vulnerable to drought-induced acidification. Since different soil parameters contribute to determining the acid neutralising capacity of peat soil or its capacity to reduce concomitant soil chemical processes, it is important to determine these parameters in order to predict effects of groundwater level lowering in response to climate warming.

### 4.5 What drives ecosystem change?

#### 4.5.1 Introduction

Changes in terrestrial ecosystems are caused by complex pathways of interacting social and biophysical factors. Over the last few decades, land use change has been the most important

Table 4.5 - Pearson coefficients of correlations between soil variables and the degree of acidification expressed as a pH difference or as a sulphate ion ( $\text{SO}_4^{2-}$ ) concentration. Only significant correlations are shown. The number of cases is indicated between brackets. (V. Van Haesebroeck, D. Boeye and P. Meire, UA-ECOBÉ).

Soil variables	Degree of acidification	
	pH	$\text{SO}_4^{2-}$ concentration
Bulk density	0.22 (180)	
% water	-0.20 (180)	
% organic matter		0.16 (178)
Initial pH	-0.30 (180)	0.16 (178)
$\text{SO}_4^{2-}$ (mg/g dry weight)		-0.32 (179)
Ca (Amac; mg/g dry weight)	-0.29 (170)	0.19 (170)
Fe (Amac; mg/g dry weight)	-0.22 (169)	
Mg (Amac; mg/g dry weight)	-0.25 (170)	
P (Amac; mg/g dry weight)	-0.16 (169)	0.16 (169)
Mg (Oxac; mg/g dry weight)	-0.21 (179)	
CEC (meq/100 $\text{cm}^3$ )	0.28 (152)	
S (meq/100 g wet soil)	0.22 (160)	

driving force of changes in species and genetic diversity (associated with endangered habitats) and of changes in soil conditions, water and sediment flows, and the vulnerability of both ecosystems and social groups. Land cover changes also contribute to climate change. Land use change, in combination with changes in nutrient stocks, soil/biomass properties, and climate, not only controls the resilience of terrestrial ecosystems but also constitutes the medium through which many human responses to global change occur. Addressing pathways

of ecosystem change means identifying typical and recurrent patterns of land change. The type of information needed for change detection is knowledge on interactions between the following three broad groups of factors: inputs or initial conditions (predisposing environmental factors, landscape history), driving factors (both proximate or direct causes and underlying driving forces), and feedback mechanisms. In addition, looking at slow versus fast variables improves the understanding of pathways of change. Data on the extent and/or rate of land

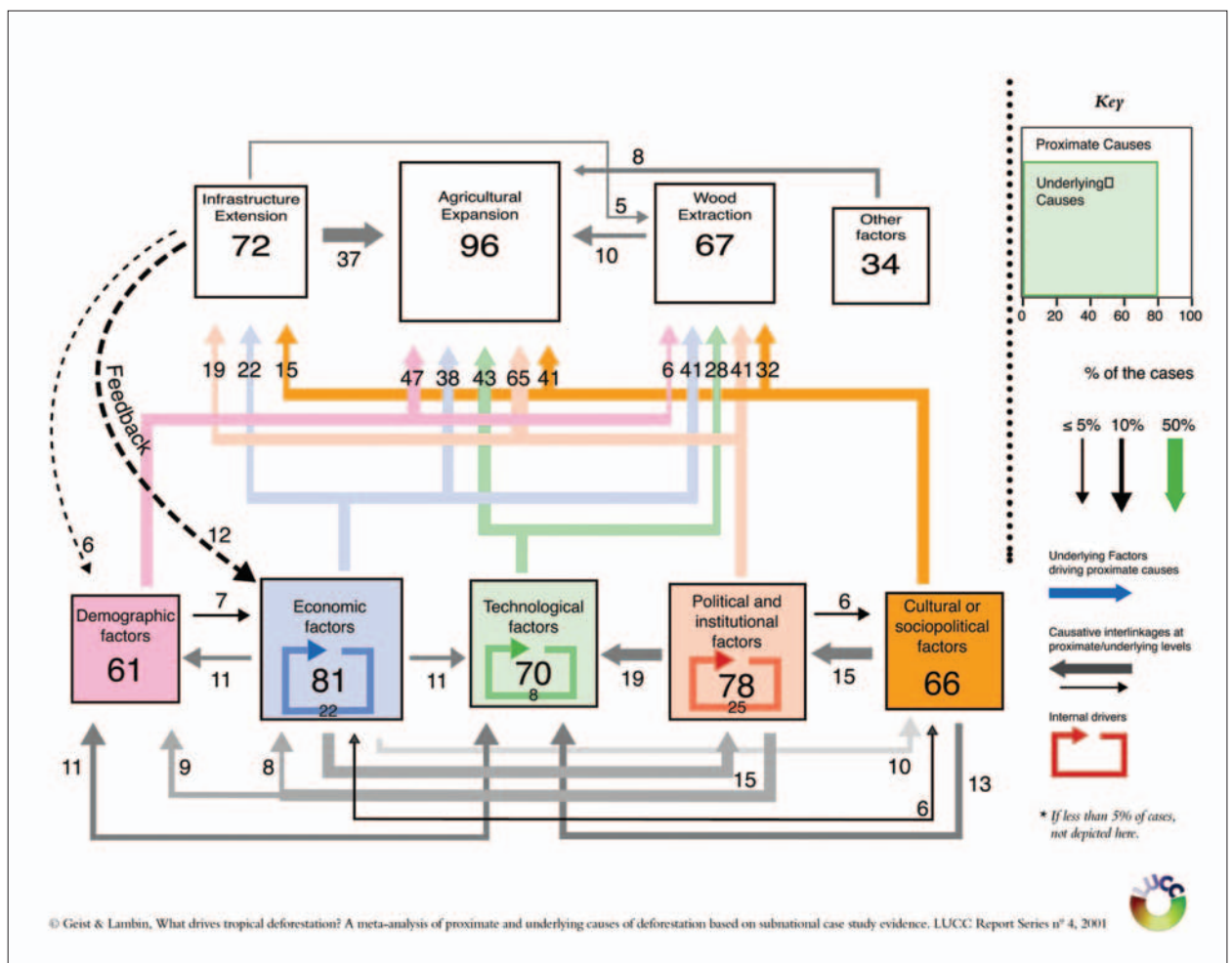

Figure 4.28 - A systemic and generalised view of the causative pattern of tropical deforestation. Systems dynamics commonly leads to tropical deforestation. No single or key variable, such as population growth or shifting cultivation, unilaterally impacts forest cover change; synergies between proximate causes and underlying (social) driving forces best explain tropical forest cover losses. A recurrent set of mainly economic, political, and institutional driving forces underpins the proximate pattern of agricultural expansion, infrastructure extension, and wood extraction, leading to deforestation. Though some investigators have claimed irreducible complexity is the explanation, distinct regional patterns do exist. (H. Geist and E. Lambin, UCL-GEOG).



## Global Change Impact on Ecosystems

change empirically support trajectories. Finally, hierarchical scales or the interplay between factors of change (local to global) need to be taken into account. Figure 4.28 summarises the factors which need to be considered in the study of ecosystem change.

### 4.5.2 Is there a single key factor of change?

The representation of interactions between factors is likely based on different patterns of ecosystem change. From a meta-analysis of nearly 300 cases of dry land and tropical forest ecosystem change, it was found that the proportion of cases in which dominant, single, or 'key' factors operate at either the proximate or the underlying level was small (approximately 10% of the cases), as was the proportion of cases explainable by pure causal chains (approximately 5% to 8%). Concomitant occurrence of causes was more widespread (approximately 25%). The most common type of interaction was synergetic factor combinations, in 70% to 90% of the case studies reviewed. Thus, there exists no single key factor of change. The mix of driving forces of land use change varies in time and space, according to specific human-environment conditions. In short, an ecosystem change function could read as follows, the F functions having forms that account for strong interactions between causes of land use change:

Land use = F (pressures, opportunities, policies, vulnerability, social organisation)

with:

- ✓ pressures = f (population of resource users, labour availability, quantity of resources, sensitivity of resources),
- ✓ opportunities = f (market prices, production costs, transportation costs, technology),
- ✓ policies = f (subsidies, taxes, property rights, infrastructure, governance),
- ✓ vulnerability = f (exposure to external

perturbations, sensitivity, coping capacity), and

- ✓ social organization = f (resource access, income distribution, household features, urban-rural interactions).

As an example, the synergistic mode of interaction between levels of causative factors, here driving the removal of tree cover in tropical forest ecosystems, is summarised in Table 4.6.

Proximate (or direct) causes of land change include human activities or immediate actions that stem from intended land use and directly affect ecosystem properties. They involve physical action on land cover such as road construction, settlement extension, wood extraction, or cropland expansion (or abandonment). Underlying (or ultimate or primary or indirect or root) causes are fundamental forces that underpin the more proximate causes of land cover change. They operate more diffusely (from a distance), often by altering one or more proximate causes. Underlying causes are formed by a complex of social, political, economic, demographic, technological, cultural, and biophysical variables that constitute initial conditions in human-environment relations and are structural (or systemic) in nature. Proximate causes generally operate at the local level (individual farms, households, or communities). In contrast, underlying causes may originate at the regional (districts, provinces, or country) or even global level, with complex interplays between levels of organisation. Synergies between these causes and initial conditions as well as feedbacks put ecosystem change on a pathway (or trajectory) of change, which can be degradation or restoration, mainly due to the nature of the feedbacks involved. Synergies may also lead to mutual cancellation of impacting factors, so that no change occurs. In most cases, however, the interaction of

Table 4.6 - Typology of the causes of land use change. (H. Geist and E. Lambin, UCL-GEOG).

	Resource scarcity causing production pressure on resources	Changing opportunities created by markets	Outside policy intervention	Loss of adaptive capacity, increased vulnerability	Changes in social organisation, in resource access, and in attitudes
Slow	<p>Natural population growth and division of land parcels</p> <p>Domestic life cycles leading to changes in labour ability</p> <p>Loss of land productivity in sensitive areas following excessive or inappropriate use</p> <p>Failure to restore or to maintain works protective of environmental resources</p> <p>Extraction additional to the one by the land manager</p>	<p>Increase in commercialisation and agro-industrialisation</p> <p>Improvement in accessibility through road construction</p> <p>Changes in market prices for inputs or outputs (e.g., erosion of prices of primary production, unfavourable global or urban-rural terms of trade)</p> <p>Off-farm wages and employment opportunities</p>	<p>Economic development programmes</p> <p>Perverse subsidies, policy-induced price distortions and fiscal incentives</p> <p>Frontier development (e.g., for geopolitical reasons or to promote interest groups)</p> <p>Poor governance and corruption</p> <p>Insecurity in land tenure</p>	<p>Impoverishment (e.g., creeping household debts, no access to credit, lack of alternative income sources; weak buffering capacity)</p> <p>Breakdown of informal social security networks</p> <p>Dependence on external resources or on assistance</p> <p>Social discrimination (ethnic minorities, women, members of lower classes or castes)</p>	<p>Changes in institutions governing access to resources by different land managers (e.g., shift from communal to private rights, tenure, holdings and titles)</p> <p>Growth of urban aspirations</p> <p>Breakdown of extended family</p> <p>Growth of urban aspirations</p> <p>Lack of public education and poor information flow regarding the environment</p>
Fast	<p>Spontaneous migration, forced population displacement, refugees</p> <p>Decrease in land availability due to encroachment by other land uses - e.g., natural reserves (i.e., the 'tragedy of enclosure')</p>	<p>Capital investments</p> <p>Changes in national or global macro-economic and trade conditions leading to changes in prices (e.g., surge in energy prices, global financial crisis)</p> <p>New technologies for intensification of resource use</p>	<p>Rapid policy changes (e.g., devaluation)</p> <p>Government instability</p> <p>War</p>	<p>Internal conflicts</p> <p>Illness (e.g., HIV)</p> <p>Risks associated with natural hazards (e.g., leading to crop failure, loss of resource or loss of productive capacity)</p>	<p>Loss of entitlements to environmental resources (e.g., expropriation for large-scale agriculture, large dams, forestry projects, tourism and wildlife conservation), leading to an ecological marginalisation of the poor</p>

factors leads to an autocatalytic process which progresses once it gets started.

### 4.5.3 Are social drivers more important than biophysical factors?

Biophysical drivers of ecosystem change can be: initial conditions of the natural environment (predisposing ecological factors, land characteristics), triggers such as droughts and forest fires, and feedbacks, mainly positive ones such as feedbacks from plant growth. Social drivers can be aggregated into five fundamental, 'high-level' causes, with land use change typically showing combinations of these causes (see Figure 4.29). Some of these fundamental causes are experienced as constraints. They force local land managers into degradation,

innovation, or displacement pathways. The other causes are associated with land managers intent on seizing new opportunities in order to realise their diverse aspirations. Each of these causes may result in slow, evolutionary processes that change incrementally on a time scale of decades or more, or in fast changes that are abrupt and occur as perturbations affecting human-environment systems suddenly. Regardless of the type of ecosystem change, impacts from the biophysical and social domains cannot be studied separately, since ecosystem change occurs in a coupled human-environmental system. The combination of drivers, however, can vary with the type of land change under study and over time. In tropical deforestation, for example, a limited set of underlying, predominantly social

# Global Change Impact on Ecosystems

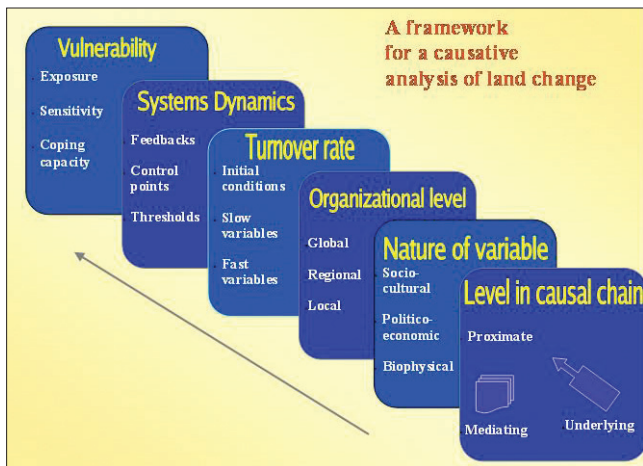

Figure 4.29 - Framework for analysing factors that drive ecosystem change. (E. Lambin and H. Geist, UCL-GEOG).

driving forces – changing market opportunities for export cash productions as shaped mainly by various pro-deforestation policies – underpin a limited set of proximate causes. Biophysical feedbacks exist, both amplifying ones (such as forest fires or droughts) and mitigating ones (such as on terrains with a rugged topography), but the human impact is overriding along one pathway of ecosystem change which is old-growth forest conversion. In the case of changing dry land ecosystems, the impact of biophysical factors is much more pronounced. Several positive feedback loops exist with strong bidirectional and self-reinforcing links between climate change and land use change, overriding or at least accentuating human impact: (i) droughts and their effects on vegetation are reinforced on a decadal time scale through a feedback mechanism that involves land surface changes caused by initial decreases in rainfall; (ii) grazing and conversion of semiarid grasslands to row-crop agriculture become sources of another positive desertification feedback loop by increasing the heterogeneity of soil resources and vegetation (as response to hydrological stress) in space and time; (iii) local land degradation, local Albedo effects and precipitation decline (inside and/or outside

the area), including high rainfall variability, are coupled in a self-perpetuating downward spiral which drives desertification and overrides any human impact.

## 4.6 Reflections, conclusions and outlook

Global change impacts are diverse and often complex. An array of coinciding global changes (rising atmospheric CO<sub>2</sub>, climate-warming, stratospheric ozone depletion, loss of biodiversity, landscape fragmentation, biological invasions, ...) currently affect a series of interrelated processes (productivity, carbon sequestration, water relations, maintenance of biodiversity, ...) across a variety of ecosystems (agricultural, forest, natural, ...). Some processes constitute a global change and an impact at the same time. For example, biodiversity loss is a key component of change across biomes, with repercussions for ecosystem functioning, while it is in turn an impact of changing patterns in global land use. Impacts on the biosphere may feed back to the factors that cause them, for example, changes in soil respiration in a warmer climate can alter the carbon balance of terrestrial ecosystems, and reinforce drivers of global warming (elevated levels of CO<sub>2</sub> and other greenhouse gases).

Apart from being warmer, future climate will be characterised by more frequent extreme events. Mitigation of global warming protects plant diversity because it prevents species-rich plant communities from losing the species most sensitive to such extremes. Future research should give priority to finding ways to make grasslands, and ecosystems in general, more robust. To assist the managers of nature reserves, new tools have been developed, based on population dynamics, to predict how biodiversity can be optimised by changing ecosystem management.

Models predict significant changes in the world's biome distribution with rising atmospheric CO<sub>2</sub> and climate-warming. In particular, substantial reductions in the extent of tundra and a northward shift in the border between temperate mixed forests and boreal evergreen forests are predicted.

Globally, forest soils contain 70% and vegetation contains 30% of the total forest carbon pool. Soil carbon pools and soil respiration are of particular importance in the global carbon budget. Because the soil organic matter pool contains twice the amount of carbon that is stored in the atmosphere, and because each year approximately 10% of the atmospheric CO<sub>2</sub> pool is released from the soil, small changes in the soil carbon pool could strongly affect atmospheric CO<sub>2</sub> concentrations. Currently, soils are assumed to be major sinks for atmospheric CO<sub>2</sub>. However, soil respiration is positively correlated with temperature. Thus, future increases in global temperature are likely to enhance carbon efflux from the soil, reducing the terrestrial sink strength and providing a positive feedback to global warming. This hypothesis depends on the relationship between the temperature dependencies of net primary productivity and soil organic matter decomposition.

Much of what we know about the contemporary global carbon budget has been learned from careful observations of the atmospheric CO<sub>2</sub> mixing ratio and the <sup>13</sup>C/<sup>12</sup>C isotope ratio, interpreted with global circulation models. From these studies, we have learned that (i) about one-third of the annual input of CO<sub>2</sub> into the atmosphere from fossil fuel combustion and deforestation is taken up by the terrestrial biosphere, and (ii) a significant portion of the net uptake of CO<sub>2</sub> occurs at mid-latitudes of the northern hemisphere, and north temperate terrestrial ecosystems in particular are involved as a large sink. These methods provide the

necessary global- and continental-scale perspectives for carbon balance calculations, but their use in addressing small temporal and spatial changes in the carbon balance is rather limited.

Forests and woodlands cover 38% of Europe. They account for more than 90% of the total carbon in terrestrial ecosystems and 68% of the annual plant and crop production. Forests and the human use of forests and forestry products have an impact on greenhouse gas concentrations in the atmosphere. There is a feedback from the climate system, whereby forests are affected by changes in climate and in the chemical composition of the atmosphere. Forest ecosystems and wood-based products also have the ability to sequester atmospheric CO<sub>2</sub>. They thus offer an opportunity to mitigate climate change. However, this balance must be correctly understood, quantified and modelled if we wish to assess the climate-change-mitigating potential of forests, to improve the reliability of predictions, and to reduce the uncertainty of the consequences of climatic change on forest ecosystems.

A major challenge, not extensively covered in the period 1990-2002, is to reconcile increases in C sequestration (aimed at mitigating climate-warming) with measures aimed at preventing further loss of biodiversity. Only recently have the potential conflicts between these two goals been identified, and research is needed in two directions: (i) what are the likely adverse effects of enhanced C sequestration on biodiversity and how can they be avoided, and (ii) what is the influence of biodiversity-promoting measures on C sequestration?

Another growing threat insufficiently covered so far by research programmes on global change is that posed by invasive plant and animal species. Today, human activity has removed many of the natural barriers to dispersal, allowing even less mobile species

## Global Change Impact on Ecosystems

to become invasive. In particular, intensified global trade, changing land use patterns, and also climate change are considered to promote invasions. Many authors regard invasion of natural communities as one of the most serious threats to biodiversity. In particular, the capacity to predict which newly observed exotic species are likely to become invasive is currently insufficient. As a consequence, the scarce means available for early control are most likely not optimally invested at the present time. In addition, the potential for controlling invasive species through land use changes is largely unexplored.

In southern Africa, India, Australia, and the Mediterranean, desertification is expected to expand. With regard to the fate of the main greenhouse gas  $\text{CO}_2$ , models have been developed and data collected that allow quantifying (within wide limits) both the soil carbon stock patterns and the net carbon exchanges of vegetation over the Belgian territory. The ratio of anthropogenically emitted carbon to carbon fixation by forest vegetation can, with sufficient accuracy, be calculated for Europe, but terrestrial carbon sinks show very strong inter-annual variability. Besides  $\text{CO}_2$ , different other greenhouse gases (such as  $\text{N}_2\text{O}$ ,  $\text{NO}$ , and  $\text{CH}_4$ ) are emitted and taken up by terrestrial ecosystems. Analysis of ecosystem change in the face of global changes has revealed that change is seldom driven by a single factor. The concomitant occurrence of several causes is frequent, and synergetic factor combinations are even more widespread. Biophysical drivers cannot be studied separately from social drivers, since ecosystem change occurs in a coupled human-environmental system.

Finally, the global carbon cycle has recently received much more attention as policy makers, leaders of government, and citizens around the world have expressed concern about documented increases in atmospheric carbon

dioxide and subsequent global warming. Here is a quote from a recent mission statement issued by an IUFRO (International Union of Forestry Research Organisations) Task Force to strengthen the interface between forest science and science policy on a global level: 'Major policymakers, such as Presidents, Kings and Prime Ministers have expressed a vision for long-term reductions in atmospheric carbon dioxide. Forests serve as a major sink for carbon dioxide and science can help policymakers realize their vision through development and implementation of new knowledge and climate change technology. The knowledge necessary to manage forests and forest resource utilization for maximum carbon sequestration is a necessity. Options for forest management policy and practices to help stop and reverse the trend is an achievable role for science'.

# Annex 1: Global change related programmes of BELSPO

General characteristics of the programmes	EUROTRAC phase I (1988-1996)	Impulse programme Marine Sciences (1992-1996)	Impulse programme Global Change (1990-1996)	Scientific Support Plan for a Sustainable (1996-2000)	
				Global Change and Sustainable Development - Reducing Uncertainties	Antarctic phase IV
<b>Steering committee</b>	no	<ul style="list-style-type: none"> <li>BELSPO</li> <li>Federal Ministries of Agriculture; Public Health and Environment</li> <li>Walloon and Brussels Capital Regions</li> <li>Flemish and French Communities</li> <li>Environmental organisations</li> </ul>	<ul style="list-style-type: none"> <li>BELSPO</li> <li>Federal Ministries of Agriculture; Public Health and Environment; Economic Affairs; Transport</li> <li>Walloon and Brussels Capital Regions</li> <li>Flemish and French Communities</li> </ul>	<ul style="list-style-type: none"> <li>BELSPO</li> <li>Federal Ministries of Agriculture; Public Health and Environment; Economic Affairs; Foreign Affairs; Finances</li> <li>Federal Planning Bureau</li> <li>DGTRE/DGA, BIM-IBGE, AMINAL-mobility, Flemish and French Communities</li> </ul> <p>observers: CLO &amp; CRA</p>	<ul style="list-style-type: none"> <li>BELSPO</li> <li>Federal Ministries of Agriculture; Foreign Affairs; Environment</li> <li>Flemish Community/Region, French and German Communities, Walloon and Brussels Capital Regions</li> </ul>
<b>Budget (€)</b>	2.8 million	4.5 million	13.5 million	17.8 million	5.7 million
<b>No. of projects</b>	11	12	27	13	9
<b>No. of teams</b>	11	16	37	43	15
<b>Type of participants</b>	universities, public research institutes	universities, public research institutes	universities, public research institutes	universities, public research institutes, non-profit research centres	universities, public research institutes, non-profit research centres
<b>Funding of European partners</b>	no	no	no	no	no
<b>Strategic objectives</b>	<ul style="list-style-type: none"> <li>Provision of an improved scientific understanding necessary for future policy development in the field of air pollution control and abatement.</li> </ul>	<ul style="list-style-type: none"> <li>Provision of scientific support for policymaking.</li> <li>Promotion of participation and integration of Belgian teams in international research and co-ordination programmes.</li> </ul>	<ul style="list-style-type: none"> <li>Provision of scientific support for policymaking.</li> <li>Promotion of participation and integration of Belgian teams in international research and co-ordination programmes.</li> </ul>	<ul style="list-style-type: none"> <li>Provision of scientific support for policymaking.</li> <li>Development and consolidation of Belgian scientific expertise.</li> <li>Promotion of participation and integration of Belgian teams in international research and co-ordination programmes.</li> </ul>	<ul style="list-style-type: none"> <li>Honouring Belgium's obligations as a founding member of the Antarctic Treaty System (ATS)</li> <li>Contribution to the development of knowledge required for a science-based conservation and management of the Antarctic environment and to the assessment of mechanisms through which the Antarctic and the global climate interact.</li> <li>Ensuring an operational interface with the ATS.</li> </ul>
<b>Scientific objectives</b>	<ul style="list-style-type: none"> <li>Provision of the scientific basis for the quantification of source-receptor relationships for photo-oxidants and acidifying substances.</li> </ul>	<ul style="list-style-type: none"> <li>Gain of insight into the physical, chemical and biological processes which govern the North Sea ecosystem.</li> <li>Study of the direct and indirect changes which can occur within these processes under the impact of human activities.</li> <li>Estimation of the consequences on the social and economic level of such changes, and the policy to be implemented with respect to this.</li> </ul>	<ul style="list-style-type: none"> <li>Gain of insight into physical, chemical and biological processes which can produce variations in the Earth system and their interactions.</li> <li>Development of models and methodologies to predict possible climate changes.</li> <li>Assessing the role of human activities in these changes.</li> </ul>	<ul style="list-style-type: none"> <li>Improvement of the understanding of physical, chemical and biological processes of change (climate, stratospheric ozone in the mid-latitudes, the oxidative capacity of the atmosphere, incl. tropospheric ozone creation) with particular attention to human-induced changes) in the Earth System and their interactions.</li> <li>Provision of information to identify and understand the problems.</li> <li>Development of tools (models, methods, etc.) to evaluate the consequences of policy options.</li> <li>Development of methods and models to explain the functioning and evolution of the climate system, its influences, and to project potential climate changes.</li> </ul>	
<b>Themes</b>	<ul style="list-style-type: none"> <li>Chemistry and transport of ozone and other photo-oxidants</li> <li>Processes leading to acidification and eutrophication</li> <li>Uptake and release of atmospheric trace substances by the biosphere</li> </ul>	<p>Dynamics of the marine ecosystem:</p> <ul style="list-style-type: none"> <li>Heavy metals and organic micropollutants: <ul style="list-style-type: none"> <li>- origin, formation, distribution and biological consequences (incl. on fish) in estuaries, coastal zones and soil sediments;</li> <li>- estimation of pollutant flows considering the physical and biogeochemical processes which regulate them</li> </ul> </li> <li>Eutrophication: <ul style="list-style-type: none"> <li>- evaluation and forecast of phytoplankton growth</li> <li>- bacterial plankton cycle</li> <li>- zooplankton grazing</li> <li>- benthos</li> </ul> </li> </ul>	<ul style="list-style-type: none"> <li>Atmospheric processes which can lead to climate changes</li> <li>Biogeochemical cycles on land and in the sea</li> <li>Global modelling of the climate and the environment</li> </ul>		<ul style="list-style-type: none"> <li>Marine biota and Global Change <ul style="list-style-type: none"> <li>- Structure, functioning and resilience of key ecosystems</li> <li>- Ecofunctional biodiversity</li> <li>- Biogeochemical cycle of carbon and global changes</li> </ul> </li> <li>Dynamics of the Southern Ocean <ul style="list-style-type: none"> <li>- General circulation in relation to the formation of deep waters</li> <li>- Dynamics of the marginal sea ice zone</li> </ul> </li> <li>Palaeoenvironmental records <ul style="list-style-type: none"> <li>- Ice caps (EPICA)</li> <li>- Marine sediments</li> </ul> </li> </ul>
<b>Participation in international networks: examples</b>	FP3, FP4	MAST, NSTF	IGBP (PAGES, IGAC, LOICZ,...), WCRP (SPARC, JGOFS,...), FP3, FP4, IHDP/IGBP (LUCC)	IGBP (PAGES, IGAC, LOICZ,...), WCRP (SPARC, JGOFS, CLIVAR, CLICs,...), FP4, FP5, IHDP/IGBP (LUCC), EUROTRAC 2	

Development Policy (SPSD)		Scientific Support Plan for a Sustainable Development Policy (SPSD II) (2000- 2005)	Research Programmes for Earth Observation		Programme for the Development of Scientific Experiments 'PRODEX' (1988- )
Sustainable Management of the North Sea	Telsat 4	Part II: Global change, ecosystems and biodiversity	'STEREO' (2001-2006)	'VEGETATION' (2001-2004)	
<ul style="list-style-type: none"> <li>BELSPO</li> <li>Federal Ministries of Economic Affairs, Middle Class; Agriculture</li> <li>Flemish Community/ Region, Walloon and Brussels Capital Regions</li> </ul> <p>observer: MUMM</p>	<ul style="list-style-type: none"> <li>BELSPO</li> <li>Federal Ministries of Agriculture; Foreign Affairs; Defence</li> <li>Walloon Region</li> <li>Flemish Community/Region</li> </ul>	<ul style="list-style-type: none"> <li>BELSPO</li> <li>Federal Ministries of Health, Food Chain Security and Environment; Economy, SMEs, Self-Employed and Energy; Foreign Affairs, Foreign Trade and Development Co-operation</li> <li>Federal Planning Bureau</li> <li>Flemish Community/Region, French Community, Walloon and Brussels Capital Regions</li> </ul>	<ul style="list-style-type: none"> <li>BELSPO</li> <li>Federal Ministries of Health, Food Chain Security and Environment; Foreign Affairs, Foreign Trade and Development Co-operation</li> <li>Walloon and Brussels Capital Regions, Flemish Community/Region, French &amp; German Community,</li> </ul>	none	none: national activities managed by ESA and BELSPO
10 million	5.9 million	33.5 million	10.8 million	2.9 million	~3 million per year
19	74	47	27	2	20
37	25	144	33	5	12
universities, public research institutes, non-profit research centres	universities, public research institutes, non-profit research centres	universities, public research institutes, non-profit research centres	universities, public research institutes, non-profit research centres, private companies, public departments		universities, public research institutes, private companies
no	no	yes, based on the principle of 50% co-financing	no		
<ul style="list-style-type: none"> <li>Provision of scientific support for policymaking.</li> <li>Development and consolidation of Belgian scientific expertise.</li> <li>Promotion of participation and integration of Belgian teams in international research and co-ordination programmes.</li> </ul>	<ul style="list-style-type: none"> <li>Anchoring the methods and results of earlier phases within the community of end-users (i.e. scientists, public administration, private sector).</li> <li>Adapting or supplementing methods and techniques: <ul style="list-style-type: none"> <li>to meet research needs,</li> <li>to be integrated in decision-making support systems,</li> <li>to permit the transfer of technology,</li> <li>to support the various opportunities offered by newly developed sensors.</li> </ul> </li> </ul>	<ul style="list-style-type: none"> <li>Development and consolidation of Belgian scientific expertise.</li> <li>Provision of scientific support for: vertical (between various levels of competence) and horizontal (between different policy fields) policy integration; drawing up and carrying out international, federal, regional and local sustainable development policies.</li> <li>Development and promotion of interdisciplinary research.</li> <li>Encouraging dialogue and exchange of information among scientists, decision makers and other actors at national level (within EU and international context).</li> <li>Integration of the basic sustainable development principles to anticipate the needs for integrated policies.</li> <li>Stimulation of the participation of researchers in international research and assessment programmes.</li> </ul>	<ul style="list-style-type: none"> <li>Maintaining and expanding the Belgian scientific expertise by incorporating researchers into internationally recognised poles of expertise.</li> <li>Development of Earth Observation-based operational products and services.</li> <li>Support of Earth Observation users.</li> <li>Valorisation and promotion of Belgian know-how.</li> </ul>		<ul style="list-style-type: none"> <li>Support to scientific teams involved in space projects</li> <li>Industrial development of scientific instruments or experiments proposed by Belgian scientists and selected by ESA.</li> <li>Stimulation and facilitation of cooperation between scientists and industry in the field of space research.</li> <li>Valorisation and promotion of Belgian know-how.</li> </ul>
<ul style="list-style-type: none"> <li>Improvement of the understanding of the structure and functioning of the North Sea ecosystem.</li> <li>Improvement of the understanding of the human activities on the North Sea ecosystem.</li> </ul>		<ul style="list-style-type: none"> <li>Improvement of the understanding of - via field studies, observation and modelling on various scales - of the flows of water, energy and matter which are generated within and between the environmental compartments earth, sea and atmosphere, as well as the alteration of these flows.</li> <li>Provision of solutions to more or less short-term environmental problems.</li> <li>Development of expertise in order to support long-term predictions and decision making.</li> </ul>	<ul style="list-style-type: none"> <li>Poles of expertise to extract information from existing and future satellite data for research purposes and application development, in particular: automation of image processing and aspects such as accuracy, reliability and reproducibility,.</li> <li>Research into testing of signal sensitivity and modelling for various variables (signal consistency: variations between seasons and years, etc.) in optical and SAR time series, and 'up scaling' of methods for field observations using data derived from space.</li> <li>Advanced research into the complementarity of optical and SAR data, and efficient integration of data of different spatial solutions, incl. further in-depth study for particular image processing techniques, e.g. fuzzy rules or neuronal networks, (wavelet-based) filter techniques, application of geo-statistical principles to satellite images, data-assimilation techniques.</li> </ul>		<ul style="list-style-type: none"> <li>Development of experiments and instruments for Earth Observation.</li> </ul>
<ul style="list-style-type: none"> <li>Eutrophication</li> <li>Chemical pollution</li> <li>Protection of species and their habitat</li> <li>Sustainable exploitation of the sea</li> <li>Setting up a data bank with data series</li> </ul>	<ul style="list-style-type: none"> <li>Global Change</li> <li>Management of natural resources</li> <li>Natural hazards and population protection</li> <li>Sustainable development in tropical countries</li> </ul>	<ul style="list-style-type: none"> <li>Atmosphere and Climate, incl. related Antarctic research</li> <li>Terrestrial Ecosystems (incl. wetlands) of the temperate Regions</li> <li>Marine (North Sea) ecosystems</li> <li>Freshwater Ecosystems of the Temperate Regions;</li> <li>Aquatic (marine - North Sea, freshwater) and terrestrial (temperate regions) and Antarctic biodiversity</li> </ul>	<ul style="list-style-type: none"> <li>Local vegetation and associated parameters, agriculture</li> <li>Cartography and land management</li> <li>Study of coastal regions</li> </ul>	<ul style="list-style-type: none"> <li>Global vegetation</li> </ul>	<ul style="list-style-type: none"> <li>Atmospheric chemistry, meteorology and climatology</li> </ul>
	CEOS, UNESCO	IGBP (PAGES, IGAC, LOICZ...), WCRP (SPARC, JGOFS, CLIVAR, CLiCs,...), IHDP/IGBP (LUCC), FP6, IPCC, MA	GMES, PRODEX, FP5, FP6, UNESCO	GMES, FP5, FP6, FAO	ESA, EUMETSAT

## Annex 2: BELSPO global change research projects

Title	Promotors	Institute	Project Website
<b>Chapter 1</b>			
Anthropogenic and biogenic influences on the oxidising capacity of the atmosphere	Muller J.-F. Vinckier C.	BIRA / IASB KULeuven-PAC	<a href="http://www.belspo.be/belspo/fedra/proj.asp?en&amp;COD=CG/DD1/02">http://www.belspo.be/belspo/fedra/proj.asp?en&amp;COD=CG/DD1/02</a>
Anthropogenic and biogenic influences on the oxidising capacity of the atmosphere	Muller J.-F. Arijs E. Peeters J. Vinckier C.	BIRA / IASB KULeuven-PAC	<a href="http://www.belspo.be/belspo/fedra/proj.asp?en&amp;COD=EV/35/6">http://www.belspo.be/belspo/fedra/proj.asp?en&amp;COD=EV/35/6</a>
ASE: Elementary composition and sources of atmospheric aerosols above and around the North Sea	Maenhaut W. Van Grieken R.	UGent-INW UA-MiTAC	<a href="http://www.belspo.be/belspo/fedra/proj.asp?en&amp;COD=E7/ASE/1">http://www.belspo.be/belspo/fedra/proj.asp?en&amp;COD=E7/ASE/1</a>
ATMOS antenna - Belgian contribution to the global study of the chemical composition and physical characteristics of the Earth's atmosphere, using infrared solar spectra recorded by ATMOS	Zander R.	ULg-GIRPAS	<a href="http://www.belspo.be/belspo/fedra/proj.asp?en&amp;COD=GC/A/03">http://www.belspo.be/belspo/fedra/proj.asp?en&amp;COD=GC/A/03</a>
Characterisation and sources of carbonaceous atmospheric aerosols	Maenhaut W. Claeys M.	UGent-INW UA-Phar	<a href="http://www.belspo.be/belspo/fedra/proj.asp?en&amp;COD=EV/02/11">http://www.belspo.be/belspo/fedra/proj.asp?en&amp;COD=EV/02/11</a>
Characterisation of aerosols and evaluation of atmospheric deposits of heavy metals in Siberia and Kazakhstan	Van Grieken R.	UA-MiTAC	<a href="http://www.belspo.be/belspo/fedra/proj.asp?en&amp;COD=BL/R/01">http://www.belspo.be/belspo/fedra/proj.asp?en&amp;COD=BL/R/01</a>
Coordination of Belgian activities in the framework of the NDSC	Simon P.	BIRA / IASB	<a href="http://www.belspo.be/belspo/fedra/proj.asp?en&amp;COD=ND/DD/001">http://www.belspo.be/belspo/fedra/proj.asp?en&amp;COD=ND/DD/001</a>
Coordination of Belgian activities in the framework of the NDSC	Zander R.	ULg-GIRPAS	
Determination of the composition and origin of the regional atmospheric aerosol at great distances from anthropogenic source areas - Research on the importance of anthropogenic impact	Maenhaut W.	UGent-INW	<a href="http://www.belspo.be/belspo/fedra/proj.asp?en&amp;COD=GC/A/01">http://www.belspo.be/belspo/fedra/proj.asp?en&amp;COD=GC/A/01</a>
Development of a specific interpolation method for air pollutants measured in automatic networks (SMOGSTOP)	Hanton J. Demuth C.	FPMS-FLUIDMACH CELINE / IRCEL	<a href="http://www.belspo.be/belspo/fedra/proj.asp?en&amp;COD=AS/DD/09">http://www.belspo.be/belspo/fedra/proj.asp?en&amp;COD=AS/DD/09</a>
ESAC I: Experimental study of atmospheric changes	Simon P. De Muer D. Colin R. Zander R.	BIRA / IASB IRM / KMI ULB-SPECAT ULg-GIRPAS	<a href="http://www.belspo.be/belspo/fedra/proj.asp?en&amp;COD=CG/DD1/01">http://www.belspo.be/belspo/fedra/proj.asp?en&amp;COD=CG/DD1/01</a>
ESAC II: Experimental study of atmospheric changes	De Maziere M. De Backer H. Colin R. Mahieu E.	BIRA / IASB IRM / KMI ULB-SPECAT ULg-GIRPAS	<a href="http://www.belspo.be/belspo/fedra/proj.asp?en&amp;COD=EV/35/3">http://www.belspo.be/belspo/fedra/proj.asp?en&amp;COD=EV/35/3</a> <a href="http://www.oma.be/ESACII/Home.html">www.oma.be/ESACII/Home.html</a>
EUROTRAC-TOPAS (Tropospheric Optical Absorption Spectroscopy), study of the troposphere by optical spectroscopy	Colin R. Simon P. Dufour P.	ULB-SPECAT BIRA / IASB UMH-FS	<a href="http://www.belspo.be/belspo/fedra/proj.asp?en&amp;COD=E7/TOPAS/1">http://www.belspo.be/belspo/fedra/proj.asp?en&amp;COD=E7/TOPAS/1</a> <a href="http://www.belspo.be/belspo/fedra/proj.asp?en&amp;COD=E7/TOPAS/3">http://www.belspo.be/belspo/fedra/proj.asp?en&amp;COD=E7/TOPAS/3</a> <a href="http://www.belspo.be/belspo/fedra/proj.asp?en&amp;COD=E7/TOPAS/2">http://www.belspo.be/belspo/fedra/proj.asp?en&amp;COD=E7/TOPAS/2</a>
Implementation and extension of the EUROS (EUROpean Operational Smog) model for policy support in Belgium	Mensink C. Dumont G. Passelecq Ch. Quinet A. Schayes G.	VITO-TAP CELINE / IRCEL FPMS-FLUIDMACH IRM / KMI UCL-ASTR	<a href="http://www.belspo.be/belspo/fedra/proj.asp?en&amp;COD=AS/DD/10">http://www.belspo.be/belspo/fedra/proj.asp?en&amp;COD=AS/DD/10</a> <a href="http://www.beleuros.be">http://www.beleuros.be</a>
LACTOZ (Laboratory Studies of Chemistry Related to Tropospheric Ozone): description and modelling of chemical processes in connection with the tropospheric ozone budget	Peeters J. Vinckier C.	KULeuven-PAC	<a href="http://www.belspo.be/belspo/fedra/proj.asp?en&amp;COD=E7/LACTOZ">http://www.belspo.be/belspo/fedra/proj.asp?en&amp;COD=E7/LACTOZ</a>
Remote sensing of the earth atmosphere. Combined satellite and ground-based IR solar absorption measurements of earth atmospheric composition	De Maziere M.	BIRA / IASB	<a href="http://www.belspo.be/belspo/fedra/proj.asp?en&amp;COD=BL/P/04">http://www.belspo.be/belspo/fedra/proj.asp?en&amp;COD=BL/P/04</a>
Role of alpha-pinene in the formation of greenhouse gases in the atmosphere	Vinckier C.	KULeuven-PAC	<a href="http://www.belspo.be/belspo/fedra/proj.asp?en&amp;COD=GC/A/05">http://www.belspo.be/belspo/fedra/proj.asp?en&amp;COD=GC/A/05</a>
SMAC: Spectroscopic Measurements of Atmospheric Changes	Simon P. Colin R. Debouille L.	BIRA / IASB ULB-SPECAT ULg-GIRPAS	<a href="http://www.belspo.be/belspo/fedra/proj.asp?en&amp;COD=GC/35/002">http://www.belspo.be/belspo/fedra/proj.asp?en&amp;COD=GC/35/002</a> <a href="http://www.belspo.be/belspo/fedra/proj.asp?en&amp;COD=GC/A/02">http://www.belspo.be/belspo/fedra/proj.asp?en&amp;COD=GC/A/02</a>
Sources, physico-chemical characteristics and climate forcing of atmospheric aerosols	Maenhaut W. Adams F. Claeys M.	UGent-INW UA-MiTAC UA-Phar	<a href="http://www.belspo.be/belspo/fedra/proj.asp?en&amp;COD=CG/DD1/03">http://www.belspo.be/belspo/fedra/proj.asp?en&amp;COD=CG/DD1/03</a>
Study of tropospheric ozone at Uccle, in relation with meteorological parameters	De Backer H.	IRM / KMI	<a href="http://www.belspo.be/belspo/fedra/proj.asp?en&amp;COD=MO/34/006">http://www.belspo.be/belspo/fedra/proj.asp?en&amp;COD=MO/34/006</a>
Study of vertically resolved ground-based FTIR measurements at the Jungfraujoch for investigating dynamical and chemical processes at northern mid-latitude	De Maziere M.	BIRA / IASB	<a href="http://www.belspo.be/belspo/fedra/proj.asp?en&amp;COD=MO/35/007">http://www.belspo.be/belspo/fedra/proj.asp?en&amp;COD=MO/35/007</a>
TOR (Tropospheric Ozone Research), determination of the total column density and vertical distribution of the atmospheric components	Zander R.	ULg-GIRPAS	<a href="http://www.belspo.be/belspo/fedra/proj.asp?en&amp;COD=E7/TOR/1">http://www.belspo.be/belspo/fedra/proj.asp?en&amp;COD=E7/TOR/1</a>
TOR (Tropospheric Ozone Research), determination of the total column density and vertical distribution of the atmospheric components	De Muer D.	IRM / KMI	<a href="http://www.belspo.be/belspo/fedra/proj.asp?en&amp;COD=E7/TOR/2">http://www.belspo.be/belspo/fedra/proj.asp?en&amp;COD=E7/TOR/2</a>



## Annex 2: BELSPO global change research projects *(continued)*

Title	Promotors	Institute	Project Website
<b>Chapter 2</b>			
A continuous Holocene record of ENSO variability in Southern Chile - A clue to a better understanding of interhemispheric climate teleconnections (ENSO-CHIL)	De Batist M. Berger A. Fagel N.	UGent-RCMG UCL-ASTR ULg-URAP	<a href="http://www.belspo.be/belspo/fedra/proj.asp?l=en&amp;COD=EV/02/10">http://www.belspo.be/belspo/fedra/proj.asp?l=en&amp;COD=EV/02/10</a> <a href="http://allserv.rug.ac.be/~fcharlet/ENSO_chile.htm">http://allserv.rug.ac.be/~fcharlet/ENSO_chile.htm</a>
An integrated approach to assess carbon dynamics in the Southern Ocean	Dehairs F. André L. Deleersnijder E. Lancelot C. Frankignoulle M.	VUB-ANCH KMMA/MRAC-GEO UCL-ASTR ULB-ESA ULg-OCEANCHEM	<a href="http://www.belspo.be/belspo/fedra/proj.asp?l=en&amp;COD=A4/DD/B11">http://www.belspo.be/belspo/fedra/proj.asp?l=en&amp;COD=A4/DD/B11</a>
Antarctic ice-sheet dynamics and climatic change: modelling and ice composition studies (AMICS)	Decleir H. Souchez R.	VUB-DG ULB-GLACIOL	<a href="http://www.belspo.be/belspo/fedra/proj.asp?l=en&amp;COD=EV/03/08">http://www.belspo.be/belspo/fedra/proj.asp?l=en&amp;COD=EV/03/08</a> <a href="http://www.vub.ac.be/DGGF/amics">http://www.vub.ac.be/DGGF/amics</a>
Climate change, international negotiations and Belgian strategies (CLIMNEG network)	van Ypersele J.-P.	UCL-ASTR	<a href="http://www.belspo.be/belspo/fedra/proj.asp?l=en&amp;COD=CG/DD1/241">http://www.belspo.be/belspo/fedra/proj.asp?l=en&amp;COD=CG/DD1/241</a> <a href="http://www.core.ucl.ac.be/climneg/default.htm">www.core.ucl.ac.be/climneg/default.htm</a>
Climate variability as recorded in Lake Tanganyika (CLIMLAKE)	André L. Descy J.-P. Deleersnijder E. Vyverman W.	KMMA/MRAC-GEO FUNDP-URBO UCL-ASTR UGent-PAE	<a href="http://www.belspo.be/belspo/fedra/proj.asp?l=en&amp;COD=EV/13/02">http://www.belspo.be/belspo/fedra/proj.asp?l=en&amp;COD=EV/13/02</a> <a href="http://www.fundp.ac.be/urbo/climlake.html">http://www.fundp.ac.be/urbo/climlake.html</a>
Composition of the ice sheets and global changes	Souchez R.	ULB-GLACIOL	<a href="http://www.belspo.be/belspo/fedra/proj.asp?l=en&amp;COD=GC/D/14">http://www.belspo.be/belspo/fedra/proj.asp?l=en&amp;COD=GC/D/14</a>
Dynamics of the Antarctic ice cap and climatic changes (a contribution to EPICA)	Decleir H.	VUB-DG	<a href="http://www.belspo.be/belspo/fedra/proj.asp?l=en&amp;COD=A3/03/002">http://www.belspo.be/belspo/fedra/proj.asp?l=en&amp;COD=A3/03/002</a>
Dynamics of the Antarctic ice cap and climatic changes (a contribution to EPICA)	Decleir H. Berger A. Gallée H.	VUB-DG UCL-ASTR	<a href="http://www.belspo.be/belspo/fedra/proj.asp?l=en&amp;COD=A4/DD/E03">http://www.belspo.be/belspo/fedra/proj.asp?l=en&amp;COD=A4/DD/E03</a> <a href="http://www.belspo.be/belspo/fedra/proj.asp?l=en&amp;COD=A4/DD/E01">http://www.belspo.be/belspo/fedra/proj.asp?l=en&amp;COD=A4/DD/E01</a>
Epica basal ice - Eastern Antarctica	Souchez R.	ULB-GLACIOL	<a href="http://www.belspo.be/belspo/fedra/proj.asp?l=en&amp;COD=A4/DD/E02">http://www.belspo.be/belspo/fedra/proj.asp?l=en&amp;COD=A4/DD/E02</a>
Gas hydrates and gas seeps in Lake Baikal	De Batist M.	UGent-RCMG	<a href="http://www.belspo.be/belspo/fedra/proj.asp?l=en&amp;COD=BL/R/10">http://www.belspo.be/belspo/fedra/proj.asp?l=en&amp;COD=BL/R/10</a>
Global changes of the chemical composition and climate due to human activity	Gérard J.-C.	ULg-LPAP	<a href="http://www.belspo.be/belspo/fedra/proj.asp?l=en&amp;COD=IT/SC/030">http://www.belspo.be/belspo/fedra/proj.asp?l=en&amp;COD=IT/SC/030</a>
Integrated modelling of the hydrological cycle in a view of climate change	Gellens D. Dautrebande S. Dassargues A. Feyen J. Smits J. Monjoie A.	IRM / KMI FUSAGx-UHAGx KULeuven-H&EG KULeuven-LSWM ULg-CEME ULg-LGIH	<a href="http://www.belspo.be/belspo/fedra/proj.asp?l=en&amp;COD=CG/DD1/08">http://www.belspo.be/belspo/fedra/proj.asp?l=en&amp;COD=CG/DD1/08</a>
Isotopic and chemical composition of Antarctic shelf ice: implications for global changes	Souchez R.	ULB-GLACIOL	<a href="http://www.belspo.be/belspo/fedra/proj.asp?l=en&amp;COD=A3/11/002">http://www.belspo.be/belspo/fedra/proj.asp?l=en&amp;COD=A3/11/002</a>
Late Quaternary climate history of coastal Antarctic environments: a multi-proxy approach	Vyverman W. Wilmotte A.	UGent-PAE ULg-CIP	<a href="http://www.belspo.be/belspo/fedra/proj.asp?l=en&amp;COD=EV/02/01">http://www.belspo.be/belspo/fedra/proj.asp?l=en&amp;COD=EV/02/01</a>
Modelling of the climatic system and its response to human activities	Berger A.	UCL-ASTR	<a href="http://www.belspo.be/belspo/fedra/proj.asp?l=en&amp;COD=GC/C/09">http://www.belspo.be/belspo/fedra/proj.asp?l=en&amp;COD=GC/C/09</a>
Modelling of the vertical processes intervening in Semtner and Chervin's model of global ocean circulation	Pichot G.	IRSNB / KBIN-MUMM	<a href="http://www.belspo.be/belspo/fedra/proj.asp?l=en&amp;COD=GC/C/11">http://www.belspo.be/belspo/fedra/proj.asp?l=en&amp;COD=GC/C/11</a>
Modelling the climate and its evolution at the global and regional scales (CLIMOD network)	Fichefet Th. van Ypersele J.-P. Gallée H. Tricot C. Decleir H. Huybrechts Ph.	UCL-ASTR  IRM / KMI VUB-DG	<a href="http://www.belspo.be/belspo/fedra/proj.asp?l=en&amp;COD=CG/DD1/09">http://www.belspo.be/belspo/fedra/proj.asp?l=en&amp;COD=CG/DD1/09</a> <a href="http://www.astr.ucl.ac.be/research.html">www.astr.ucl.ac.be/research.html</a>
Modelling the evolution of climate and sea level over the third millennium (MILMO)	Fichefet Th.	UCL-ASTR	<a href="http://www.belspo.be/belspo/fedra/proj.asp?l=en&amp;COD=EV/10/09">http://www.belspo.be/belspo/fedra/proj.asp?l=en&amp;COD=EV/10/09</a> <a href="http://www.climate.be/research/MILMO">http://www.climate.be/research/MILMO</a>
Natural Holocene climate variability and the recent anthropogenic impact in Belgium	Seret G.	UCL-GEOL	<a href="http://www.belspo.be/belspo/fedra/proj.asp?l=en&amp;COD=CG/DD1/12">http://www.belspo.be/belspo/fedra/proj.asp?l=en&amp;COD=CG/DD1/12</a>
Paleoenvironmental and paleoclimatic reconstructions	Malcorps H.	IRM / KMI	<a href="http://www.belspo.be/belspo/fedra/proj.asp?l=en&amp;COD=BL/34/B01">http://www.belspo.be/belspo/fedra/proj.asp?l=en&amp;COD=BL/34/B01</a>
Palaeo environment in Central Asia during the Pleistocene epoch	André L.	KMMA/MRAC-GEO	<a href="http://www.belspo.be/belspo/fedra/proj.asp?l=en&amp;COD=BL/37/R04">http://www.belspo.be/belspo/fedra/proj.asp?l=en&amp;COD=BL/37/R04</a>
Recent ENSO and paleo-ENSO of the last 1000 years in Lake Tanganyika	Klerkx J. Plisnier P.-D. Lambin E. Seret G. Vyverman W.	KMMA/MRAC-GEO  UCL-GEOG UCL-GEOL UGent-PAE	<a href="http://www.belspo.be/belspo/fedra/proj.asp?l=en&amp;COD=CG/DD1/10">http://www.belspo.be/belspo/fedra/proj.asp?l=en&amp;COD=CG/DD1/10</a>
Sensitivity study of the hydrological cycle - Impact of the climate change induced by a doubling of the atmospheric CO <sub>2</sub> content	Malcorps H.	IRM / KMI	<a href="http://www.belspo.be/belspo/fedra/proj.asp?l=en&amp;COD=GC/E/23">http://www.belspo.be/belspo/fedra/proj.asp?l=en&amp;COD=GC/E/23</a>

## Annex 2: BELSPO global change research projects (continued)

Title	Promotors	Institute	Project Website
<b>Chapter 2</b>			
Study of distinct and sudden climatic fluctuations, not directly linked to astronomical causes and attributed to the post-glacial reorganisation of the global atmospheric and oceanic circulations	Seret G.	UCL-GEOL	<a href="http://www.belspo.be/belspo/fedra/proj.asp?l=en&amp;COD=GC/D/15">http://www.belspo.be/belspo/fedra/proj.asp?l=en&amp;COD=GC/D/15</a>
Three-dimensional modelling of the continental cryosphere	Declair H.	VUB-DG	<a href="http://www.belspo.be/belspo/fedra/proj.asp?l=en&amp;COD=GC/C/10">http://www.belspo.be/belspo/fedra/proj.asp?l=en&amp;COD=GC/C/10</a>
Understanding the decadal-century-to-millenia climate variability by simulating extreme paleoclimatic situations	Berger A.	UCL-ASTR	<a href="http://www.belspo.be/belspo/fedra/proj.asp?l=en&amp;COD=CG/DD1/13">http://www.belspo.be/belspo/fedra/proj.asp?l=en&amp;COD=CG/DD1/13</a>
Validation of alternative marine calcareous skeletons as recorders of global climate change (CALMARS)	Willenz Ph. André L. Blust R. Dubois Ph. Munhoven G. Dehairs F. Declair H.	IRSNB / KBIN- Invertebrates KMMA/MRAC-GEO UA-EFB ULB-BIOMAR ULg-LPAP VUB-ANCH VUB-DG	<a href="http://www.belspo.be/belspo/fedra/proj.asp?l=en&amp;COD=EV/36/04">http://www.belspo.be/belspo/fedra/proj.asp?l=en&amp;COD=EV/36/04</a> <a href="http://www.vub.ac.be/calmar/index.htm">http://www.vub.ac.be/calmar/index.htm</a>

<b>Chapter 3</b>			
AMORE: Eutrophication and the structure of coastal planktonic food-webs: mechanisms and modelling	Lancelot C. Pichot G. Daro M.	ULB-ESA IRSNB / KBIN- MUMM VUB-ECOL	<a href="http://www.belspo.be/belspo/fedra/proj.asp?l=en&amp;COD=MN/DD1/002">http://www.belspo.be/belspo/fedra/proj.asp?l=en&amp;COD=MN/DD1/002</a>
Assessing the sensitivity of the Southern Ocean's biological carbon pump to climate change (BELCANTO II)	Dehairs F.	VUB-ANCH	<a href="http://www.belspo.be/belspo/fedra/proj.asp?l=en&amp;COD=EV/03/07">http://www.belspo.be/belspo/fedra/proj.asp?l=en&amp;COD=EV/03/07</a>
Biogeochemical carbon, nitrogen and phosphorus fluxes in the North Sea (CANOPY)	Baeyens W. Chou L. Frankignoulle M.	VUB-ANCH ULB-OCEAN ULg-OCEANCHEM	<a href="http://www.belspo.be/belspo/fedra/proj.asp?l=en&amp;COD=EV/03/20">http://www.belspo.be/belspo/fedra/proj.asp?l=en&amp;COD=EV/03/20</a>
Biogeochemistry of nutrients, metals and organic micropollutants in the North Sea	Van Grieken R. Van Langenhove H. Wollast R. Baeyens W.	UA-MiTAC UGent-OC ULB-OCEAN VUB-ANCH	<a href="http://www.belspo.be/belspo/fedra/proj.asp?l=en&amp;COD=MN/DD1/001">http://www.belspo.be/belspo/fedra/proj.asp?l=en&amp;COD=MN/DD1/001</a>
Dynamic of eutrophicated coastal systems	Lancelot C. André L. Frankignoulle M.	ULB-ESA KMMA/MRAC-GEO ULg-OCEANCHEM	<a href="http://www.belspo.be/belspo/fedra/proj.asp?l=en&amp;COD=MS/A2/07">http://www.belspo.be/belspo/fedra/proj.asp?l=en&amp;COD=MS/A2/07</a>
Global changes in the transport of nutrients from the continents to the ocean	Billen G.	ULB-GMMA	<a href="http://www.belspo.be/belspo/fedra/proj.asp?l=en&amp;COD=GC/B/08">http://www.belspo.be/belspo/fedra/proj.asp?l=en&amp;COD=GC/B/08</a>
Production, transport and destination of organic material and associated elements in marine systems	Baeyens W. Bouqueneau J.-M. Wollast R.	VUB-ANCH ULg-OCEANBIO ULB-OCEAN	<a href="http://www.belspo.be/belspo/fedra/proj.asp?l=en&amp;COD=GC/B/07">http://www.belspo.be/belspo/fedra/proj.asp?l=en&amp;COD=GC/B/07</a>
Quality status and terrestrial inputs for the North Sea	Baeyens W. Van Grieken R. Vanderborght J.-P. Wollast R.	VUB-ANCH UA-MiTAC ULB-OCEAN	<a href="http://www.belspo.be/belspo/fedra/proj.asp?l=en&amp;COD=MN/DD2/001">http://www.belspo.be/belspo/fedra/proj.asp?l=en&amp;COD=MN/DD2/001</a>
Role of oceanic production and dissolution of calcium carbonate in climate change (CCCC)	Chou L. Van Grieken R. Daro M.	ULB-OCEAN UA-MiTAC VUB-ECOL	<a href="http://www.belspo.be/belspo/fedra/proj.asp?l=en&amp;COD=EV/05">http://www.belspo.be/belspo/fedra/proj.asp?l=en&amp;COD=EV/05</a> <a href="http://www.ulb.ac.be/sciences/dste/ocean/carbonate/frame.html">http://www.ulb.ac.be/sciences/dste/ocean/carbonate/frame.html</a>
Silica retention in the Scheldt continuum and its impact on coastal eutrophication (SISCO)	Chou L. Vyverman W.	ULB-OCEAN UGent-PAE	<a href="http://www.belspo.be/belspo/fedra/proj.asp?l=en&amp;COD=EV/11/17">http://www.belspo.be/belspo/fedra/proj.asp?l=en&amp;COD=EV/11/17</a> <a href="http://www.ulb.ac.be/sciences/dste/ocean/SISCO/frame.html">http://www.ulb.ac.be/sciences/dste/ocean/SISCO/frame.html</a>
Spatial and seasonal variability of the transport of biogenic compounds in the Southern Ocean	Dehairs F.	VUB-ANCH	<a href="http://www.belspo.be/belspo/fedra/proj.asp?l=en&amp;COD=A3/03/001">http://www.belspo.be/belspo/fedra/proj.asp?l=en&amp;COD=A3/03/001</a>
Study of the geochemical cycles of particulate heavy metals and organic micropollutants in the North Sea environment	Van Grieken R.	UA-MiTAC	<a href="http://www.belspo.be/belspo/fedra/proj.asp?l=en&amp;COD=MS/A1/05">http://www.belspo.be/belspo/fedra/proj.asp?l=en&amp;COD=MS/A1/05</a>
The global carbon cycle and the future atmospheric CO <sub>2</sub> level	Gérard J.-C. Wollast R. Veroustraete F.	ULg-LPAP ULB-OCEAN VITO-TAP	<a href="http://www.belspo.be/belspo/fedra/proj.asp?l=en&amp;COD=CG/DD1/11">http://www.belspo.be/belspo/fedra/proj.asp?l=en&amp;COD=CG/DD1/11</a>
Transfer and behaviour of trace metals in the estuary of the Scheldt	Wollast R.	ULB-OCEAN	<a href="http://www.belspo.be/belspo/fedra/proj.asp?l=en&amp;COD=MS/A1/06">http://www.belspo.be/belspo/fedra/proj.asp?l=en&amp;COD=MS/A1/06</a>

## Annex 2: BELSPO global change research projects *(continued)*

Title	Promotors	Institute	Project Website
<b>Chapter 4</b>			
Biogeochemical cycles of forest ecosystems related to global change and sustainable development (BELFOR)	Lemur R. Laitat E. Van Slycken J. Ceulemans R. André P. François L. Gérard J.-C. Van Rensbergen J. Veroustraete F.	UGent-PLANTECO FUSAGx-ECOPHYS IBW UA-PLECO UCL-EFOR ULg-LPAP VITO-TAP	<a href="http://www.belspo.be/belspo/fedra/proj.asp?l=en&amp;COD=CG/DD1/05">http://www.belspo.be/belspo/fedra/proj.asp?l=en&amp;COD=CG/DD1/05</a> <a href="http://www.vito.be/belfor">http://www.vito.be/belfor</a>
Carbon sequestration potential in different Belgian terrestrial ecosystems: quantification and strategic exploration (CASTEC)	Van Cleemput O. Carlier L. Lemur R. Hofman G Lust N.	UGent-ISOFYS CLO-DFE UGent-PLANTECO UGent-SOILMAN	<a href="http://www.belspo.be/belspo/fedra/proj.asp?l=en&amp;COD=EV/02/12">http://www.belspo.be/belspo/fedra/proj.asp?l=en&amp;COD=EV/02/12</a> <a href="http://ftbwww.rug.ac.be/CASTEC">http://ftbwww.rug.ac.be/CASTEC</a>
Eco-physiological study of a forest ecosystem subject to high CO <sub>2</sub> contents in open-air chambers	Impens R.	FUSAGx-ECOPHYS	<a href="http://www.belspo.be/belspo/fedra/proj.asp?l=en&amp;COD=GC/E/16">http://www.belspo.be/belspo/fedra/proj.asp?l=en&amp;COD=GC/E/16</a>
Estimating greenhouse gas fluxes from Belgian ecosystems under global change scenarios (METAGE)	Van Wesemael B. Laitat E. Van Orshoven J.	UCL-GEOG FUSAGx-ECOPHYS KULeuven-LFNL	<a href="http://www.belspo.be/belspo/fedra/proj.asp?l=en&amp;COD=EV/14">http://www.belspo.be/belspo/fedra/proj.asp?l=en&amp;COD=EV/14</a> <a href="http://www.geo.ucl.ac.be/metage/index.html">http://www.geo.ucl.ac.be/metage/index.html</a>
Global change effects of increased atmospheric CO <sub>2</sub> content and increase of the air temperature on grassland systems	Impens I. Behaeghe T. Kretzschmar J.	UA-PLECO UGent-PP VITO	<a href="http://www.belspo.be/belspo/fedra/proj.asp?l=en&amp;COD=GC/E/17">http://www.belspo.be/belspo/fedra/proj.asp?l=en&amp;COD=GC/E/17</a> <a href="http://bio-www.uia.ac.be/bio/pleco">http://bio-www.uia.ac.be/bio/pleco</a>
Hydrological, soil chemical and ecological effects of climate change in species rich fens	Verheyen R.	UA-ECOBE	<a href="http://www.belspo.be/belspo/fedra/proj.asp?l=en&amp;COD=GC/E/19">http://www.belspo.be/belspo/fedra/proj.asp?l=en&amp;COD=GC/E/19</a> <a href="http://bio-www.uia.ac.be/bio">http://bio-www.uia.ac.be/bio</a>
Integrated modelling of the hydrological cycle in a view of climate change	Gellens D. Dautrebande S. Dassargues A. Feyen J. Smitz J. Monjoie A.	IRM / KMI FUSAGx-UHAGx KULeuven-H&EG KULeuven-LSWM ULg-CEME ULg-LGIH	<a href="http://www.belspo.be/belspo/fedra/proj.asp?l=en&amp;COD=CG/DD1/08">http://www.belspo.be/belspo/fedra/proj.asp?l=en&amp;COD=CG/DD1/08</a>
Linking dispersal, connectivity, and landscape structure to produce habitat evaluation/restoration guidelines	Baguette M. Le Boulengé E. Mathysen E.	UCL-ECOL UA-DECO	<a href="http://www.belspo.be/belspo/fedra/proj.asp?l=en&amp;COD=EV/10/16A">http://www.belspo.be/belspo/fedra/proj.asp?l=en&amp;COD=EV/10/16A</a> <a href="http://bio-www.uia.ac.be/bio/deco">http://bio-www.uia.ac.be/bio/deco</a>
Remote sensing of land-cover change and biomass burning processes in the tropics	Lambin E.	UCL-GEOG	<a href="http://www.belspo.be/belspo/fedra/proj.asp?l=en&amp;COD=T4/DD/01">http://www.belspo.be/belspo/fedra/proj.asp?l=en&amp;COD=T4/DD/01</a>
Sensitivity study of the hydrological cycle - Impact of the climate change induced by a doubling of the atmospheric CO <sub>2</sub> content	Malcorps H.	IRM / KMI	<a href="http://www.belspo.be/belspo/fedra/proj.asp?l=en&amp;COD=GC/E/23">http://www.belspo.be/belspo/fedra/proj.asp?l=en&amp;COD=GC/E/23</a>
Species diversity: Importance for sustainable ecosystems and impact of climate change	Impens I. Nijs I. Reheul D.	UA-PLECO UGent-PP	<a href="http://www.belspo.be/belspo/fedra/proj.asp?l=en&amp;COD=CG/DD1/04">http://www.belspo.be/belspo/fedra/proj.asp?l=en&amp;COD=CG/DD1/04</a> <a href="http://bio-www.uia.ac.be/bio/pleco">http://bio-www.uia.ac.be/bio/pleco</a>

## Annex 3: Research products

Type	Name / short description	Application
<b>1. AIR QUALITY</b>		
<b>1.a) Aerosols</b>		
algorithm	Optical inversion of aerosol properties	Derivation of aerosol properties (size distribution, number density,...) from remote sensing observations
dataset	Climatology of aerosol properties	Inputs in numerical models of the atmosphere (radiative transfer, heterogeneous chemistry)
dataset	Timeseries of aerosol properties and their vertical distributions from satellite observations, since 1985	Inputs in numerical models of the atmosphere (radiative transfer, heterogeneous chemistry); Trend evaluations
dataset	Aerosol composition datasets from campaigns in Gent, Belgium: - Gent winter and summer 1998 - Gent winter 2000-2001 and summer 2001	- Detailed organic speciation of the carbonaceous aerosol for urban sites - Source identification and apportionment
dataset	Aerosol composition datasets from campaigns in Gent, Belgium: - Gent winter and summer 1998 - Gent fall 1999 - Gent winter 2000-2001 and summer 2001	- Detailed atmospheric aerosol composition for urban sites - Source identification and apportionment - Modelling of carbonaceous aerosol constituents
dataset	Aerosol composition datasets from campaigns in Africa and South America: - South Africa (SAFARI-2000) - South America (SMOCC-2002)	- Detailed organic speciation of the carbonaceous aerosol - Source identification and apportionment
dataset	Aerosol composition datasets from campaigns in Africa and South America: - South Africa (SAFARI-92) - South Africa (SAFARI-2000) - South America (SMOCC-2002)	- Detailed atmospheric aerosol composition - Source identification and apportionment - Chemical mass closure studies
dataset	Aerosol composition datasets from campaigns in Europe: - EUROTRAC North-Sea Experiment 1992 - EUROTRAC-2 Intercomp 2000 - Budapest, Hungary 2002	- Detailed atmospheric aerosol composition - Source identification and apportionment - Chemical mass closure studies
dataset	Long-term aerosol composition datasets for a site in Africa: - Rukomechi, Zimbabwe, 1994-2000	- Monitoring atmospheric composition for natural background sites - Modelling of PM <sub>2.5</sub> and PM <sub>10</sub> - Modelling of important aerosol constituents
dataset	Long-term aerosol composition datasets for background sites in Asia: - Sde Boker, Israel, 1995- - Bukit Tinggi, Indonesia, 1996-2001 - Pontianak, Indonesia, 1997-2001	- Monitoring atmospheric composition for natural background sites - Modelling of PM <sub>2.5</sub> and PM <sub>10</sub> - Modelling of important aerosol constituents
dataset	Long-term aerosol composition datasets for natural background sites in Europe: - Ny Alesund, Spitsbergen, 1991- - Sevetijarvi, Finland, 1993-1996 - Skreadalen, Norway, 1991-1996 - Birkenes, Norway, 1991-1996	- Monitoring atmospheric composition for natural background sites - Modelling of PM <sub>2.5</sub> and PM <sub>10</sub> - Modelling of important aerosol constituents - Assessing natural and anthropogenic contributions for important aerosol constituents
dataset	Long-term aerosol composition datasets for urban and near-city sites in Belgium: - Gent, 1993-1994 - Waasmunster, 1994-1995	- Monitoring atmospheric composition for urban and near-city sites - Modelling of PM <sub>2.5</sub> and PM <sub>10</sub> - Modelling of important aerosol constituents
indicator	Development of chemical indicators for some natural and anthropogenic source types	Source identification and apportionment
instrument	Development of aerosol samplers	Size-fractionated aerosol collection
methodology	Detailed chemical characterisation of the carbonaceous aerosol, especially by applying gas chromatography and mass spectrometry	Monitoring atmospheric composition
methodology	Physico-chemical aerosol characterisation, especially by performing bulk analyses with a combination of techniques	Monitoring atmospheric composition
service	Aerosol mapping service	Tool to process aerosol optical densities for extraction of aerosol properties and mapping
<b>1.b) General</b>		
algorithm	Retrieval algorithms for inversion of optical remote sensing data from ground and space (balloon, satellite, ...); algorithms include radiative transfer and (in some cases) couplings with chemical box models	Derivation of information about the vertical distribution of trace gases and aerosols, a.o. for use in trend analyses, numerical models, validation exercises
algorithm	Implementation and intercomparison of retrieval algorithms of relevance to the ATMOS project and NDSC	Faster and more reliable retrievals of atmospheric constituents' concentration profiles from space and column abundances from the ground
dataset	Pressure-temperature profiles from radiosondes and synoptic weather observations	Input for weather forecast and atmospheric models
dataset	Laboratory measurements of fundamental optical properties of molecules present in the Earth's atmosphere (HITRAN and GEISA databases)	Identification and concentration measurements of atmospheric components
dataset	Timeseries of CO and O <sub>3</sub> vertical profiles above Jungfraujoch from FTIR ground-based measurements (1997-2002). CO profiles have been validated against MOPITT satellite data and insitu surface data	Evaluation of the atmospheric composition and its evolution, incl. its vertical structure from the surface to the middle stratosphere
dataset	Contributions to Spectroscopic databases like HITRAN, GEISA (NO <sub>2</sub> , N <sub>2</sub> O <sub>4</sub> , O <sub>2</sub> , COS, SO <sub>2</sub> , C <sub>2</sub> H <sub>2</sub> , H <sub>2</sub> O, HDO, HOCl, 13 CFCs and HFCs)	Support of measurements of atmospheric constituents with spectroscopic means
dataset	Laboratory measurements of spectroscopic parameters (positions, intensities, widths) for atmospheric constituents: CFC replacements, C <sub>2</sub> H <sub>2</sub> , HOCl, OCS, N <sub>2</sub> O, ...	Updates of data available in spectroscopic databases such as HITRAN and GEISA

Scale	Contact persons		Website
global	Fussen D. De Mazière M.	BIRA / IASB	<a href="http://www.oma.be/BIRA-IASB/Scientific/Topics/Lower/UserApp/User.html">http://www.oma.be/BIRA-IASB/Scientific/Topics/Lower/UserApp/User.html</a>
global	Fussen D.	BIRA / IASB	
global	Fussen D. De Mazière M.	BIRA / IASB	<a href="http://www.oma.be/BIRA-IASB/Scientific/Topics/Lower/UserApp/User.html">http://www.oma.be/BIRA-IASB/Scientific/Topics/Lower/UserApp/User.html</a>
local	Claeys M.	UA-Phar	
local	Maenhaut W.	UGent-INW	for Gent fall 1999: <a href="http://ccu.ei.jrc.it/ccu/">http://ccu.ei.jrc.it/ccu/</a>
regional	Claeys M.	UA-Phar	
regional	Maenhaut W.	UGent-INW	
local, regional	Maenhaut W.	UGent-INW	
regional	Maenhaut W.	UGent-INW	
regional	Maenhaut W.	UGent-INW	
regional	Maenhaut W.	UGent-INW	<a href="http://ccu.ei.jrc.it/ccu/">http://ccu.ei.jrc.it/ccu/</a> (NOT for Ny Alesund)
local	Maenhaut W.	UGent-INW	<a href="http://ccu.ei.jrc.it/ccu/">http://ccu.ei.jrc.it/ccu/</a>
local, regional	Claeys M.	UA-Phar	
local, regional	Maenhaut W.	UGent-INW	
local, regional	Claeys M.	UA-Phar	<a href="http://www.uia.ac.be/far/departement_e/massa/menu_massa.html">http://www.uia.ac.be/far/departement_e/massa/menu_massa.html</a>
local, regional	Maenhaut W.	UGent-INW	<a href="http://aivwww.ugent.be/Onderzoeksbeleid/techno2002/EN/WE/I-WE08V04.htm">http://aivwww.ugent.be/Onderzoeksbeleid/techno2002/EN/WE/I-WE08V04.htm</a>
global	de Mazière M.	BIRA / IASB	<a href="http://www.oma.be/BIRA-IASB/Scientific/Topics/Lower/UserApp/User.html">http://www.oma.be/BIRA-IASB/Scientific/Topics/Lower/UserApp/User.html</a>
global	de Mazière M. Van Roozendaal M. Fussen D.	BIRA / IASB	<a href="http://www.oma.be/ESACIL/Home.html">http://www.oma.be/ESACIL/Home.html</a>
regional to global	Zander R. Mahieu E.	ULg-GIRPAS	<a href="http://atmos.jpl.nasa.gov/atmos/">http://atmos.jpl.nasa.gov/atmos/</a> ; <a href="http://www.ndsc.ws">http://www.ndsc.ws</a>
regional	De Backer H.	IRM / KMI	<a href="http://www.ozone.meteo.be/">http://www.ozone.meteo.be/</a>
global	Colin R. Carleer M.	ULB-SPECAT	<a href="http://www.ulb.ac.be/cpm">www.ulb.ac.be/cpm</a>
local	de Mazière M.	BIRA / IASB	<a href="http://www.oma.be/ESACIL/Home.html">http://www.oma.be/ESACIL/Home.html</a>
global	Simon P.C. Colin R. Vander Auwera M.	BIRA / IASB ULB-SPECAT	<a href="http://www.hitran.com">http://www.hitran.com</a> <a href="http://ara.lmd.polytechnique.fr">http://ara.lmd.polytechnique.fr</a> <a href="http://www.oma.be/BIRA-IASB/Scientific/Topics/Lower/LaboBase/laboratory.html">http://www.oma.be/BIRA-IASB/Scientific/Topics/Lower/LaboBase/laboratory.html</a> <a href="http://www.ulb.ac.be/cpm">http://www.ulb.ac.be/cpm</a>
all	Vander Auwera J. Herman M.	ULB-SPECAT	<a href="http://www.ulb.ac.be/cpm">http://www.ulb.ac.be/cpm</a>

## Annex 3: Research products *(continued)*

Type	Name / short description	Application
dataset	Atmospheric concentrations of selected target gases. A contribution to the NADIR archive	Participation in European field campaigns; Support to the validation of global satellite measurements and the testing of atmospheric model calculations
Indicator	EC-EUROSAT environmental pressure indicators for the EU	Support to European environmental policies, e.g., CAFE
instrument, methodology	Development and automatization of spectroscopic instruments for remote sensing of the atmosphere	Deployment in network observatories or in campaign activities for long- and short-term monitoring of the atmosphere
instrument, strategy	Contributions to proposals and industrial consultancy for future satellite missions (ACE, TROC)	Contributions to design of future satellite experiments, in international collaboration
instrument, strategy	Committee on Earth Observation Satellites (CEOS) Atmospheric Chemistry Sub Group (ACSG)	Inter-agency consultation for an integrated approach of satellite calibration/validation, field research campaigns and ground-based monitoring networks
map	BASCOE: global data assimilation analyses	Delivery of consistent pictures of the atmospheric composition, based on observational and model data; short-term forecasting of the atmospheric composition
map	Distribution of calculated chemical compounds using models	A priori information in algorithms for the retrieval of these compounds using space-borne instruments (e.g., IMG/ADEOS)
methodology	Characterisation, intercomparisons and synergic exploitation of remote-sensing data from different sources; Validation of satellite data	Identification of information content of remote-sensing data for correct interpretation and usage; use of independent global measurements (ground-based network, satellites) to validate satellite data for geophysical usage and synergic exploitation
methodology	Assessment environmental impact on the air compartment of the fluoro-ethers imported/produced in Belgium	Evaluation substitutes for the CFC's and HCFC's
methodology, technique	BASCOE: statistics on the operational assimilation	Identification of possible problems in near-real time observations; assimilation error covariance description improvements based on the assimilation statistics.
model	Chemistry-transport models for the troposphere - MOZART I	Chemical forecast for estimating the anthropogenic and natural influences on the composition of the troposphere
model	Chemistry-transport models for the troposphere - IMAGES	Inverse modelling: estimation of surface emissions of tropospheric pollutants including GHG and ozone precursors based on satellite, ground-based and aircraft observations
service	TEMIS	Web-based service for delivery of tropospheric data products (NO <sub>2</sub> , O <sub>3</sub> , SO <sub>2</sub> , BrO, H <sub>2</sub> CO) from GOME and ENVISAT
standard	Fundamental spectroscopic parameters measurements in the laboratory	Identification of molecules in measurements
standard	Development of generic archiving and formatting standards for oceanographic and atmospheric datasets with applications to ENVISAT calibration/validation	Standard intelligent data formats will enable the creation of quality-controlled, searchable databases for multiple usage; the standard will be adopted widely by satellite missions and databases in the near future
standard	Algorithm standard service: contribution to homogenisation of retrieval tools across the community	Distribution of retrieval software (WinDOAS)
standard, methodology	Methodology for the calculation of the GWP of HCFCs	Impact CFC substituents on global warming
<b>1.c) Ozone general</b>		
dataset	Trace gas measurement global data sets from ERS2 and ENVISAT	Trend calculations; Input for chemical models
dataset	Ozone vertical distribution and trends at Uccle (corrected for interferences with SO <sub>2</sub> )	Evolution tropospheric and stratospheric ozone; Model validation
dataset	Total ozone time series with different spectrophotometers at Uccle	Evolution stratospheric ozone; Model validation
standard	Contribution to the determination of standard operating procedures for ozone sounding	Monitoring atmospheric composition
<b>1.d) Stratospheric ozone</b>		
dataset	ATMOS-derived concentration profiles and budgets of nitrogen-, chlorine-, and fluorine constituents throughout the middle atmosphere. A contribution to the NASA-ATLAS Mission to Planet Earth	Understanding the impact of anthropogenic perturbations on the stratospheric ozone depletion; Providing concentrations of numerous source gases in the free troposphere.
dataset	Observations of the concentrations of O <sub>3</sub> , halogen, nitrogen compounds, CO, CH <sub>4</sub> and some greenhouse gases in October 2002 at B61 (FTIR ground-based campaign data)	Contribution to NDSC observations in the tropics
dataset	NDSC timeseries for O <sub>3</sub> , NO <sub>2</sub> , BrO, and OCIO concentrations at Jungfraujoch, Harestua and Observatoire de Haute Provence, archived locally and in European and international databases	Evaluation of the atmospheric composition and its evolution
dataset	Climatology and long-term trends of column abundances of stratospheric ozone and other key stratospheric gases; contribution to the NDSC archive	Monitoring the secular evolution of the stratospheric ozone layer, in support of the Vienna Convention and the Montreal Protocol
indicator	Indicators for the state of the ozone layer (1999, 2000, 2001, 2002) for the MIRA report	Evaluation of the effect of measures undertaken to improve the environment
indicator	Indicators of increased halogen loading, in particular ClO, BrO, HCl, ClONO <sub>2</sub> , CFC, HCFC	Contribution to verification of Montreal and Kyoto Protocols
instrument, algorithm	Ground-based observation stations in Brussels and Ile de la Réunion and participation in international atmospheric measurement campaigns	Determination of atmospheric composition from satellites (ACE, IASI,...) and ground-based measurements
instrument, strategy	Development and maintenance of ground-based (Jungfraujoch station) and airborne (stratospheric balloon platform) remote-sensing systems. Science advisory support in the concept and observation strategy of space-based remote sensing instruments (e.g., ATMOS, MIPAS)	Operation of remote sensing instruments to study the chemical composition of the atmosphere as well as its variability and its secular evolution. Resulting datasets are of relevance to the Montreal and Kyoto Protocols.
inventory	Gridded global inventories for the emissions of tropospheric pollutants (tropospheric ozone precursors)	Input to numerical models predicting the composition of the global atmosphere

Scale	Contact persons		Website
regional to global	Mahieu E. Zander R.	ULg-GIRPAS	<a href="http://nadir.nilu.no/calval">http://nadir.nilu.no/calval</a>
regional	Zander R.	ULg-GIRPAS	<a href="http://europa.eu.int/comm/environment/air/cafe/">http://europa.eu.int/comm/environment/air/cafe/</a>
	de Mazière M. Van Roozendaal M.	BIRA / IASB	<a href="http://www.oma.be/ESACIL/Home.html">http://www.oma.be/ESACIL/Home.html</a>
all	de Mazière M.	BIRA / IASB	
all	Lambert J.-C.	BIRA / IASB	<a href="http://www.wgcvceos.org/subgroups/acsg.htm">http://www.wgcvceos.org/subgroups/acsg.htm</a>
global	Fonteyn D.	BIRA / IASB	<a href="http://BASCOE.oma.be/">http://BASCOE.oma.be/</a>
global	Muller J.-F.	BIRA / IASB	
global	Lambert J.-C. De Mazière M. Van Roozendaal M.	BIRA / IASB	<a href="http://www.oma.be/GOME/GOMEVAL">http://www.oma.be/GOME/GOMEVAL</a>
regional, global	Vinckier C.	KULeuven-PAC	
global	Fonteyn D.	BIRA / IASB	<a href="http://BASCOE.oma.be/">http://BASCOE.oma.be/</a>
global	Muller J.-F.	BIRA / IASB	
global	Muller J.-F.	BIRA / IASB	
global	Fonteyn D. Van Roozendaal M.	BIRA / IASB	<a href="http://www.temis.nl/">http://www.temis.nl/</a>
global	Colin R. Carleer M.	ULB-SPECAT	
global	de Mazière M.	BIRA / IASB	<a href="http://nadir.nilu.no/calval/">http://nadir.nilu.no/calval/</a>
global	Van Roozendaal M. Fayt C.	BIRA / IASB	
global	Colin R. Carleer M. Vander Auwera M.	ULB-SPECAT	
global	De Backer H.	IRM / KMI	<a href="http://www.ozone.meteo.be/">http://www.ozone.meteo.be/</a>
regional	De Backer H.	IRM / KMI	<a href="http://www.ozone.meteo.be/">http://www.ozone.meteo.be/</a>
regional	De Backer H.	IRM / KMI	<a href="http://www.ozone.meteo.be/">http://www.ozone.meteo.be/</a>
all	De Backer H.	IRM / KMI	<a href="http://www.ozone.meteo.be/">http://www.ozone.meteo.be/</a>
global	Zander R. Mahieu E.	ULg-GIRPAS	<a href="http://atmos.jpl.nasa.gov/atmos/">http://atmos.jpl.nasa.gov/atmos/</a> ; <a href="http://remus.jpl.nasa.gov/atmos/">http://remus.jpl.nasa.gov/atmos/</a>
local	de Mazière M. Carleer M.	BIRA / IASB ULB-SPECAT	<a href="http://www.oma.be/ESACIL/Home.html">http://www.oma.be/ESACIL/Home.html</a>
regional	Van Roozendaal M. De Mazière M.	BIRA / IASB	<a href="http://www.oma.be/ESACIL/Home.html">http://www.oma.be/ESACIL/Home.html</a>
regional	Zander R. Mahieu E.	ULg-GIRPAS	<a href="http://www.astro.ulg.ac.be/Grech/girpas_f.html">http://www.astro.ulg.ac.be/Grech/girpas_f.html</a> ; <a href="http://www.ndsc.ws/">http://www.ndsc.ws/</a> ; <a href="http://www.unep.ch/ozone">http://www.unep.ch/ozone</a>
regional	De Backer H.	IRM / KMI	<a href="http://www.ozone.meteo.be/en_rapport_op">http://www.ozone.meteo.be/en_rapport_op</a> <a href="http://www.vmm.be">http://www.vmm.be</a>
regional	Zander R. Van Roozendaal M.	ULg-GIRPAS BIRA / IASB	<a href="http://www.oma.be/ESACIL/Home.html">http://www.oma.be/ESACIL/Home.html</a>
global	Colin R. Carleer M.	ULB-SPECAT	<a href="http://www.ulb.ac.be/cpm">www.ulb.ac.be/cpm</a>
regional to global	Delbouille L. Servais C. Zander R.	ULg-GIRPAS	<a href="http://www.ifjungo.ch/">http://www.ifjungo.ch/</a> ; <a href="http://envisat.esa.int/instruments/mipas/">http://envisat.esa.int/instruments/mipas/</a> ; <a href="http://atmos.jpl.nasa.gov/atmos">http://atmos.jpl.nasa.gov/atmos</a>
global	Muller J.-F.	BIRA / IASB	

## Annex 3: Research products *(continued)*

Type	Name / short description	Application
map	Total ozone data are transferred to the WOUDC in near real-time where daily total ozone maps are generated (whole period)	Follow up of the evolution of the ozone distribution in near real time
dataset, map	O <sub>3</sub> , BrO, SO <sub>2</sub> and NO <sub>2</sub> global data sets from GOME and ENVISAT; associated maps of BrO, SO <sub>2</sub> , NO <sub>2</sub>	Evaluation of the atmospheric composition and its evolution; map-wise presentation and delivery to users.
methodology	Development of validated methodologies for the construction of explicit oxidation mechanisms of complex (biogenic) VOC	Modelling the formation of atmospheric photo-chemical oxidants from (biogenic) VOCs and NO <sub>x</sub>
methodology, technique	Methodologies for the homogenization of the time series of total ozone and ozone profiles	Making the datasets useful for trend analysis
methodology, technique	Correction of DOBSON ozone observations for the influence of SO <sub>2</sub>	Monitoring atmospheric composition
<b>1.e) tropospheric ozone</b>		
dataset	Mechanistic/kinetic input data on biogenic VOC reactions in the troposphere	Used directly or indirectly on a European level for scenario evaluations concerning the reduction of photochemical oxidant formation from VOCs and NO <sub>x</sub>
dataset	Theoretical kinetic/mechanistic input data on oxidation reactions of VOCs in the atmosphere	Global atmospheric chemistry models, and scenario evaluations for reducing tropospheric ozone formation from VOCs and NO <sub>x</sub>
instrument	Fast-flow reactor: laboratory technique for simulations of atmospheric reactions, including radicals	Study of biogenic VOC (terpenes) oxidation with hydroxyl radicals
map	Geographical distribution of ozone as modelled over Europe (1990-2010)	Visual interpretation of trends in peak and background ozone concentrations
map	Kinetic data on ion molecule reactions H <sub>3</sub> O <sup>+</sup> , O <sub>2</sub> <sup>+</sup> and NO <sup>+</sup> with VOCs of atmospheric interest	Laboratory measurements through Chemical Ionization techniques and detection methods of VOCs in atmosphere
methodology, technique	Evaluation of the impact of short-term, local emission reduction measures versus long-term, large scale emission reductions	Assessment of policy measures related to the federal ozone plan: assessment of the impact of national emission ceilings on ozone, acidification and eutrophication in Belgium
methodology, technique	Cryotrapping-sampling: capture on a liquid nitrogen trap, detection and quantification of semi-volatile and reactive carbonyl compounds formed in terpene oxidation	Assessment of the importance of biogenic versus anthropogenic VOCs in atmospheric chemistry
methodology, technique	SMOGSTOP model	Enhancement of an interpolation method for the automatic air pollution monitoring network
methodology, technique	Ozone regression models for the evaluation of long-term reduction measures	Evaluation of the efficiency of long-term policy measures
model	BELEUROS: tropospheric ozone model, installed at IRCEL in Brussels	Assessment of the impact of policy measures on tropospheric ozone concentration in Belgium and Europe
model	OZON94 & OZON97: modelling the impact of various emission scenario's on peak and background ozone concentrations; comparisons with trends in measurements	Evaluation of the efficiency of long-term policy measures
model	Estimating external costs of the impacts (environmental damage) of tropospheric ozone on human health, forests and crops	Evaluation efficiency policy measures
<b>1.f) UV</b>		
dataset	UV spectral measurements	Monitoring radiation at the surface
methodology, technique, dataset	Aerosol optical depth in the UV at Uccle	Monitoring atmospheric composition
dataset	Timeseries and climatologies of UV spectral irradiances at Uccle	Evaluation of trends and correlations with stratospheric O <sub>3</sub> decrease
model	Radiative transfer model	Predictions of UV index for warning the public of danger
<b>2. BIODIVERSITY</b>		
dataset	Antarctic benthos	Understanding the C-cycle in Antarctic benthos
model	Focal species and the designation and management of marine protected areas: sea- and coastal birds in Belgian marine waters.	
model	Modelling based on regression equations per species	
model	Predictive HABITAT model to link sedimentological and biological data (biodiversity - Antarctica)	
<b>3. CLIMATE CHANGE</b>		
<b>3.a) general</b>		
dataset	Climatology and long-term trends of column abundances of all important atmospheric source gases, natural and anthropogenic combined.	Study of the secular evolution of the composition of the troposphere, within the framework of the UNFCCC and in support of the Kyoto Protocol.
dataset	Contribution to the mass-balance and glacier retreat history in the Altai Mountains, Russia	Mass balance, velocity and ice thickness measurements of Sofiyskiy and Maliy Aktru glaciers in Altai Mountains
dataset	Lake Tanganyika (compilation of old data and acquisition of new ones): fisheries, temperatures, nutrients, meteorological data, biogeochemical monitoring	Climate change study (past, present and future), fisheries and ecology.



Scale	Contact persons		Website
global	De Backer H.	IRM / KMI	<a href="http://www.woudc.org">www.woudc.org</a>
global	Van Roozendaal M.	BIRA / IASB	
local, regional	Peeters J.	KULeuven-PAC	<a href="http://arrhenius.chem.kuleuven.ac.be/labpeeters/labpeeters_nl.html">http://arrhenius.chem.kuleuven.ac.be/labpeeters/labpeeters_nl.html</a>
local	De Backer H.	IRM / KMI	<a href="http://www.ozone.meteo.be/">http://www.ozone.meteo.be/</a>
all	De Muer D.	IRM / KMI	<a href="http://www.ozone.meteo.be/">http://www.ozone.meteo.be/</a>
regional, global	Vinckier C.	KULeuven-PAC	<a href="http://www.fz-juelich.de/icg/icg-ii/CMD_DATA_PANEL/">http://www.fz-juelich.de/icg/icg-ii/CMD_DATA_PANEL/</a>
local, regional, global	Peeters J.	KULeuven-PAC	<a href="http://arrhenius.chem.kuleuven.ac.be/labpeeters/labpeeters_nl.html">http://arrhenius.chem.kuleuven.ac.be/labpeeters/labpeeters_nl.html</a> ; <a href="http://www.fz-juelich.de/icg/icg-ii/CMD_DATA_PANEL/">http://www.fz-juelich.de/icg/icg-ii/CMD_DATA_PANEL/</a>
regional, global	Vinckier C.	KULeuven-PAC	<a href="http://arrhenius.chem.kuleuven.ac.be/fysanal/method_nl.html#stroomhuis">http://arrhenius.chem.kuleuven.ac.be/fysanal/method_nl.html#stroomhuis</a>
national, European	Mensink C.	VITO-TAP	
	Arijs E.	BIRA / IASB	
local, national	Mensink C.	VITO-TAP	
regional, global	Vinckier C.	KULeuven-PAC	
	Passelecq Ch.	FPMS-FLUIDMACH	
national, European	Mensink C.	VITO-TAP	
national, European	Mensink C.	VITO-TAP	<a href="http://www.beleuros.be">http://www.beleuros.be</a>
national, European	Mensink C.	VITO-TAP	<a href="http://www.belspo.be/belspo/home/publ/pub_ostc/mobil/rMD14_nl.pdf">http://www.belspo.be/belspo/home/publ/pub_ostc/mobil/rMD14_nl.pdf</a>
national	Torfs R.	VITO	
local	De Backer H.	IRM / KMI	<a href="http://www.ozone.meteo.be">http://www.ozone.meteo.be</a>
all	De Backer H.	IRM / KMI	<a href="http://www.ozone.meteo.be">http://www.ozone.meteo.be</a>
local	Simon P.C. De Backer H.	BIRA / IASB IRM / KMI	<a href="http://www.bira.be/Scientific/Topics/solaRad/Ground/UVB/html">http://www.bira.be/Scientific/Topics/solaRad/Ground/UVB/html</a> ; <a href="http://www.meteo.be/ozon/uv/">http://www.meteo.be/ozon/uv/</a>
all	De Muer D. De Backer H.	IRM / KMI	<a href="http://www.bira.be/scientific/topics/solarad/ground/UVB.html">http://www.bira.be/scientific/topics/solarad/ground/UVB.html</a> and <a href="http://www.ozone.meteo.be">http://www.ozone.meteo.be</a>
regional	Vincx M.	UGent-MARBIOL	
	Debacker V.	ULg	
regional	Vincx M.	UGent-MARBIOL	
regional	Vincx M.	UGent-MARBIOL	
regional	Mahieu E. Zander R.	ULg-GIRPAS	<a href="http://www.astro.ulg.ac.be/Grech/girpas_f.html">http://www.astro.ulg.ac.be/Grech/girpas_f.html</a> ; <a href="http://unfccc.int">http://unfccc.int</a> ; <a href="http://europa.eu.int/comm/environment/climate/eccp.htm">http://europa.eu.int/comm/environment/climate/eccp.htm</a> ; <a href="http://www.nilu.no/niluweb/services/soge/">http://www.nilu.no/niluweb/services/soge/</a>
regional	Decler H. Pattyn F.	VUB-DG	<a href="http://homepages.vub.ac.be/~fpattyn/altai_res.html">http://homepages.vub.ac.be/~fpattyn/altai_res.html</a>
regional	Descy J.-P./Plisnier P.-D. André L./Plisnier P.-D. Vyverman W./Cocquyt C. Deleersnyder E.	FUNDP-URBO KMMA / MRAC UGent-PAE UCL-ASTR	

## Annex 3: Research products *(continued)*

Type	Name / short description	Application
dataset	Gridded datasets for the Greenland ice sheet: accumulation rate, precipitation rate, surface elevation, ice thickness, bedrock topography (5-10-20 km resolution)	Modeling the Greenland ice sheet
dataset	The deepest part of the GRIP ice core: $\delta D$ and $\delta^{18}O$ , $CO_2$ , $O_2$ , $N_2$ , $CH_4$ concentrations, ice fabrics, $NH_4$ , Cl and dielectric properties measurements	Showing that the central part of the Greenland Ice Sheet has been built up from an ice cap formed in the Eastern mountain range and indicating the original local biotope
dataset	Belgian climatic database (daily extreme temperatures and precipitation) 1954-2000	Evolution of the climate
dataset	Diatom dataset based on a biweekly sampling (February 2002 – end 2004) in Lake Tanganyika	Climate variability modeling for Lake Tanganyika and reconstruction of past productivity in the lake
dataset	$N_2O$ emission factors for Belgian agriculture	National emission inventories (UNFCCC, EEA,...)
dataset	BELFOR metadatabase	Overview of the available data related to meteorological, hydrological and physiological parameters or characteristics of forest sites
dataset	Belgian climatic database (daily extreme temperatures and precipitation) 1954-2000	evolution climate
dataset	SOC stocks for 1950-1970 at the LSU level, calculated for 10 cm depth increments up to 1 m	Greenhouse gas emission inventories (UNFCCC, Kyoto protocol, EEA,...), carbon sinks
dataset	SOC contents in arable land and grassland at the 'commune level' for 1990-2000. These data are a compilation of routine soil fertility analysis	Greenhouse gas emission inventories (UNFCCC, Kyoto protocol, EEA,...), carbon sinks
fact	Knowledge on natural sources of greenhouse gasses	Emission inventories (for UNFCCC, EEA,...)
indicator	'Dielectric properties' measurements in the bottom part of the GRIP ice core and chemical measurements ( $NH_4$ and Cl) within the ice	Showing that physical and chemical properties of ice are indicators of the paleoenvironment (periglacial biotope in the present case)
indicator	Indicator species in phytoplankton (diatoms), sensible to climatic driven changes in lake hydrology, productivity and geochemistry.	Climate variability modeling for Lake Tanganyika and reconstruction of past productivity in the lake
indicator	Refinement of Ba-use as a proxy for carbon export in the Southern Ocean	Quantification of carbon storage and mineralisation in the oceanic intermediate and deepwaters
Instrument	Isotope Ratio Mass Spectrometer	Process-oriented studies
Inventory	C-Stocks, $N_2O$ from agriculture, $CH_4$ from landfills	Greenhouse gas emission inventories (UNFCCC, Kyoto protocol, EEA,...), carbon sinks
inventory	C-stocks found in different forest compartments	Carbon pools in different Belgian forest ecosystems
inventory	GIS-based inventory system for GHG fluxes from terrestrial ecosystems.	Greenhouse gas emission inventories (UNFCCC, Kyoto protocol, EEA,...), carbon sinks
map	Information on the correlation between climate variability in East Africa and Pacific ocean climate and oceanic conditions (El Niño)	Forecasting of climate conditions in East Africa useful for agriculture, fisheries or health...
map	Two original maps of East Africa showing teleconnections between vegetation and surface temperature with Pacific Ocean temperature 6 months earlier	Forecasting ecological conditions in East Africa (useful for agriculture, fisheries or wild life)
map	Baikal Lake: methane emission maps from the lake surface to the atmosphere	Emission inventories (UNFCCC, EEA,...)
map	Maps of Belgium depicting SOC stocks for 1950, 1990 and 2000	Greenhouse gas emission inventories (UNFCCC, Kyoto protocol, EEA,...), carbon sinks
methodology	CAT	Understanding complex model results
methodology, indicator	Development of silicon isotopes measurements	Proxy validation and quantification of phytoplankton (diatoms) efficiency
methodology, technique	Emission measurement of GHG from terrestrial ecosystems	Refinement of emission factors, IPCC Emission Factor Database, 2006 IPCC Guidelines
methodology, technique	Prediction of methane release in the atmosphere from gas hydrates	emission inventories (UNFCCC, EEA,...)
model	MoBiDic at 2 dimensions: latitude-altitude, atmosphere + ocean + inlandis + vegetation	
model	ICE2D-HO	Development of a two-dimensional higher-order flowline model for glacier and ice sheet ice flow simulation
model	Sea-ice ocean general circulation models: CLIO and ORCALIM	Climate change and climate variability
model	Hydrodynamic model of Lake Tanganyika (SLIM = Simple Limnological Model)	Prediction fishing areas and understanding past climates
model	ECO-HYDRO: integrating climate and weather data, hydrodynamics, nutrient availability, primary production, and geochemical indicators for predicting upwelling and internal waves from wind pattern and velocity	Interpretation of lake sediments and past climate conditions (last 1500 years) and understanding future changes of the lake conditions
model	Coupled atmosphere-sea ice-ocean general circulation model	Climate change scenarios
model	LOVECLIM: fully coupled ECBILT-VECODE-CLIO-LOCH-AGISM Earth system model of intermediate complexity	Evolution of climate and sea-level changes over the period 1500-2000 in response to both natural and anthropogenic forcings, projections for the future and exploration of the threat of possible rapid climate and sea-level changes

Scale	Contact persons		Website
regional	Huybrechts Ph.	VUB-DG	<a href="http://homepages.vub.ac.be/~phuybrec/research.html">http://homepages.vub.ac.be/~phuybrec/research.html</a>
regional	Lorrain R. Souchez R. Tison J.L.	ULB-GLACIOL	<a href="ftp://ftp.ngdc.noaa.gov/paleo/icecore/greenland/summit/grip/isotopes/isobas.txt">ftp://ftp.ngdc.noaa.gov/paleo/icecore/greenland/summit/grip/isotopes/isobas.txt</a>
local	Tricot C.	IRM / KMI	
local	Vyverman W. Cocquyt C.	UGent-PAE	
regional	Boeckx P. Van Cleemput O.	UGent-ISOFYS	<a href="http://ftbwww.uGent.be/isofys">http://ftbwww.uGent.be/isofys</a>
national	Lemeur R.	UGent-PLANTECO	<a href="http://www.vito.be/belfor">http://www.vito.be/belfor</a> (remark : metadatabase only accessible for project partners)
local	Tricot C.	IRM / KMI	
national	Van Orshoven J.	KULeuven-LFNL	
national	Van Wesemael B.	UCL-GEOG	
global	De Batist M.	UGent-RCMG	
regional	Souchez R. Tison J.L.	ULB-GLACIOL	
local	Vyverman W. Cocquyt C.	UGent-PAE	
regional	André L Dehairs F.	KMMA / MRAC VUB-ANCH	
regional	Boeckx P. Van Cleemput O.	UGent-ISOFYS	<a href="http://ftbwww.uGent.be/isofys">http://ftbwww.uGent.be/isofys</a>
national	Boeckx P. Van Cleemput O.	UGent-ISOFYS	<a href="http://ftbwww.ugent.be/isofys">http://ftbwww.ugent.be/isofys</a> , <a href="http://ftbwww.ugent.be/CASTEC">http://ftbwww.ugent.be/CASTEC</a>
national	Lemeur R.	UGent-PLANTECO	<a href="http://www.vito.be/belfor/belfor5_en.htm">http://www.vito.be/belfor/belfor5_en.htm</a>
national	Van Wesemael B.	UCL-GEOG	
regional	Descy J.-P./Plisnier P.-D. André L./Plisnier P.-D. Vyverman W./Cocquyt C. Deleersnyder E.	FUNDP-URBO KMMA / MRAC UGent-PAE UCL-ASTR	
regional	Descy J.-P./Plisnier P.-D. André L./Plisnier P.-D. Vyverman W./Cocquyt C. Deleersnyder E.	FUNDP-URBO KMMA / MRAC UGent-PAE UCL-ASTR	
regional	De Batist M.	UGent-RCMG	
national	Van Orshoven J.	KULeuven-LFNL	
global	Deleersnijder E.	UCL-ASTR	
regional	André L.	KMMA / MRAC	
regional	Boeckx P. Van Cleemput O.	UGent-ISOFYS	<a href="http://ftbwww.uGent.be/isofys">http://ftbwww.uGent.be/isofys</a>
regional	De Batist M.	UGent-RCMG	
global	Berger A. Loutre M.-F.	UCL-ASTR	<a href="http://www.astr.ucl.ac.be/tools/mobidic.html">http://www.astr.ucl.ac.be/tools/mobidic.html</a>
all	Decler H. Pattyn F.	VUB-DG	<a href="http://homepages.vub.ac.be/~fpattyn/2dmodel.html">http://homepages.vub.ac.be/~fpattyn/2dmodel.html</a>
global	Deleersnijder E. Goosse H.	UCL-ASTR	<a href="http://www.astr.ucl.ac.be/tools/clio.html">http://www.astr.ucl.ac.be/tools/clio.html</a> <a href="http://www.lodyc.jussieu.fr/opa/">http://www.lodyc.jussieu.fr/opa/</a>
regional	Deleersnijder E. Naithani J.	UCL-ASTR	
regional, global	Descy J.-P./Plisnier P.-D. André L./Plisnier P.-D. Vyverman W./Cocquyt C. Deleersnyder E.	FUNDP-URBO KMMA / MRAC UGent-PAE UCL-ASTR	
global	Fichefet T.	UCL-ASTR	
global	Fichefet T.	UCL-ASTR	<a href="http://www.astr.ucl.ac.be/research/MILMO/description.html">www.astr.ucl.ac.be/research/MILMO/description.html</a>

## Annex 3: Research products *(continued)*

Type	Name / short description	Application
model	Sea ice model and a three-dimensional Earth system model of intermediate complexity, which are currently used by several European laboratories	Climate studies
model	Melt-and-runoff model for the Greenland ice sheet	Prediction of surface mass balance of the Greenland ice sheet and contribution to sea level change
model	The Huybrechts 3D model of the Greenland ice sheet	Simulation of the Greenland ice sheet in relation to climate change; prediction of volume and sea level change; interpretation of ice cores
model	DYE 3 model for multiple ice deformation processes at the ice/bedrock interface of the Greenland ice sheet	Showing how deep ice behaves at the base of ice sheets and can have implications for long-term chronology from dynamical models.
model	DeNitrification-DeComposition model	GHG inventories at the regional scale
model	CARAIB	Study of the carbon cycle in the terrestrial biosphere and especially the contribution of land ecosystems to atmospheric CO <sub>2</sub> sequestration
model	Descriptive models for the energy budget, the hydrological cycle, the carbon and nutrient cycles in Belgian forest ecosystems	Prediction of changes in these pools and fluxes under a series of realistic climate scenarios
model	3 D atmospheric mesoscale model: MAR (Modèle Atmosphérique Régional) for climatology (horizontal grid size between 10 and 40 km)	Determination of climatic elements (temperature, wind, precipitations...) at a regional scale. Application : study of past or future regional climatology; interactions between polar katabatic winds and the ice in polar regions.
model, map, algorithm, imagery, biophysical product	C-Fix methodology for quantification of carbon fluxes in terrestrial ecosystems integrating satellite observation (e.g. VEGETATION) and ecosystem models. Products generated: maps, images, graphs of the important components of carbon cycle (mass productivity) in forest ecosystems from continental to global scale	Quantification of C-fluxes components in forest ecosystems, including C-fluxes from soils, assessment of the implementation of the Kyoto Protocol.
strategy	EISMINT	Intercomparison project of ice sheet models
indicator	SOC indicators for agricultural land by the OECD	Greenhouse gas emission inventories (UNFCC, Kyoto Protocol, EEA,...), carbon sinks; soil quality monitoring
model	Sea ice model and a three-dimensional Earth system model of intermediate complexity, which are currently used by several European laboratories	Climate studies
model	Nested climate model	Regional climate predictions
model	EFOBEL aboveground biomass calculated from the Walloon and Flanders forest inventories.	Greenhouse gas emission inventories (UNFCC, Kyoto Protocol, EEA,...), carbon sinks
<b>3.b) Antarctica</b>		
dataset	Antarctica: East Queen Maud Land / Enderby Land Glaciological Folio	Delivery of subglacial topography measurements in the Sør Rondane Mountains for compilation of glaciological folio edited by NIPR (Japan)
dataset	Contribution to VELMAP: international database on Antarctic ice dynamics	Inventory of ice speeds of Antarctic outlet glaciers and ice streams (e.g. Shirase Glacier) obtained from field measurements and radar interferometry
dataset	EPICA dating DML ice core	Dating and calculation of particle paths of the EPICA deep ice core in Dronning Maud Land by numerical ice sheet modelling: inclusion of ICE3D-HO model in the Huybrechts model for the Antarctic ice sheet
dataset	McCall Glacier, North Alaska, USA: ice thickness measurements	Ice thickness measurements within the framework of international Arctic research
dataset	Gridded datasets for the Antarctic ice sheet: accumulation rate, precipitation rate, surface elevation, ice thickness, bedrock topography (5-10-20 km resolution)	Modeling the Antarctic ice sheet
dataset	Lake Popplewell, isotopic, ionic and gas concentration profiles from a perennially frozen lake of the Dry Valleys	Indicating that, contrary to many others, this type of Antarctic lakes has been frozen from top to bottom and is still completely frozen.
dataset	Lake Vostok deep ice properties (mainly stable isotopes) - detailed investigation	Showing that folding and intermixing of ice has occurred in the basal part of the Ice Sheet; finding very old ice with a proper chronology in the Vostok core is thus very unlikely
dataset	Marine ice at Hells Gate Ice Shelf (HGIS) and Nansen Ice Sheet (NIS): salinity, isotopic and ionic records, and texture of the ice	Indicating that a significant part of these Antarctic ice shelves have been formed in the water column below
dataset	Beacon Valley, data on the 8 million year old ice (oldest in the world) buried (preserved) in East Antarctica	Indicating the relative stability of the East Antarctic Ice Sheet since the Miocene
dataset	Diatom dataset for East Antarctic ice free oases, including the Larsemann Hills, the Vestfold Hills, the Windmill Islands, the Rauer Islands and the Bolingen Islands	Climate change and biodiversity studies of protists, development of inference models to reconstruct climate change
dataset, map	Contribution to BEDMAP: international database on Antarctic subglacial topography	Ice thickness measurements in Dronning Maud Land, Antarctica by Belgian Antarctic Expeditions and participation in International Antarctic expeditions
indicator	Molecular markers for lakes in the Larsemann Hills, the Dry Valleys and the Vestfold Hills	Climate change reconstruction in lake sediment cores
indicator	Biological palaeoecological indicators (pigments) in fossil mats of Antarctic lakes	Reconstruction of past taxonomical composition of the autotrophic organisms in the foodwebs of marine and lacustrine environments in Antarctica

Scale	Contact persons		Website
regional	Fichefet T.	UCL-ASTR	
regional	Huybrechts Ph.	VUB-DG	<a href="http://homepages.vub.ac.be/~phuybrec/research.html">http://homepages.vub.ac.be/~phuybrec/research.html</a>
regional	Huybrechts Ph.	VUB-DG	<a href="http://homepages.vub.ac.be/~phuybrec/research.html">http://homepages.vub.ac.be/~phuybrec/research.html</a>
regional	Lorrain R. Souchez R. Tison J.L.	ULB-GLACIOL	
regional	Boeckx P. Van Cleemput O.	UGent-ISOFYS	<a href="http://ftbwww.ugent.be/isofys">http://ftbwww.ugent.be/isofys</a>
global, regional	Gérard J.-Cl	ULg-LPAP	
national	Lemeur R. Lust N. Ceulemans R. Van Slijcken Laitat E. André P. Gérard J.-C. Remacle Veroustraete F.	UGent-PLANTECO UGent-SOILMAN UA-PLECO IBW FUSAGx-ECOPHYS UCL-EFOR ULg-LPAP ULg VITO-TAP	<a href="http://www.vito.be/belfor/belfor5_en.htm">http://www.vito.be/belfor/belfor5_en.htm</a>
regional	Schayes G.	UCL-ASTR	<a href="http://www.astr.ucl.ac.be/">http://www.astr.ucl.ac.be/</a>
regional, continental, global	Veroustraete F.	VITO-TAP	<a href="http://www.eoworks.com/introduction.htm">http://www.eoworks.com/introduction.htm</a>
all	Decleir H. Pattyn F.	VUB-DG	<a href="http://homepages.vub.ac.be/~phuybrec/eismint.html">http://homepages.vub.ac.be/~phuybrec/eismint.html</a>
national	Van Wesemael B.	UCL-GEOG	
regional	Fichefet T.	UCL-ASTR	
regional	van Ypersele J.-P.	UCL-ASTR	
national	Perrin D.	FUSAGx	
regional	Decleir H. Pattyn F.	VUB-DG	<a href="http://www.nipr.ac.jp">http://www.nipr.ac.jp</a>
regional	Decleir H. Pattyn F.	VUB-DG	<a href="http://homepages.vub.ac.be/~fpattyn/shirase.html">http://homepages.vub.ac.be/~fpattyn/shirase.html</a>
regional	Decleir H. Pattyn F.	VUB-DG	
regional	Decleir H. Pattyn F.	VUB-DG	
regional	Huybrechts Ph.	VUB-DG	<a href="http://homepages.vub.ac.be/~phuybrec/datasets/datasets.html">http://homepages.vub.ac.be/~phuybrec/datasets/datasets.html</a>
regional	Lorrain R.	ULB-GLACIOL	
regional	Lorrain R. Souchez R.	ULB-GLACIOL	
regional	Lorrain R. Souchez R. Tison J.L.	ULB-GLACIOL	
regional	Souchez R. Tison J.L.	ULB-GLACIOL	
regional	Vyverman W. Wilmotte A.	UGent-PAE ULg-CIP	
regional	Huybrechts Ph. Decleir H. Pattyn F.	VUB-DG	<a href="http://www.antarctica.ac.uk/aedc/bedmap/">http://www.antarctica.ac.uk/aedc/bedmap/</a>
regional	Vyverman W. Wilmotte A.	UGent-PAE ULg-CIP	
regional	Vyverman W. Wilmotte A.	UGent-PAE ULg-CIP	

## Annex 3: Research products *(continued)*

Type	Name / short description	Application
indicator	Transfer function	Quantitative moisture balance modeling in East Antarctic lakes
indicator, dataset	Experimental simulation of freezing of carbonate bearing solutions in the basal zone of glaciers or refreezing of meltwaters in contact with rock debris within ice sheets	Indicating that potential secondary processes can affect the palaeoclimatic signal in ice cores
methodology technique	Antarctica: numerical methods in environmental modelling	Development and application of advanced numerical techniques for modelling ice sheets and glaciers
methodology technique	Method for determining the sea ice growth rate and energy fluxes from chemical and isotopic composition of the ice	Indicating the thermal conditions of sea ice formation even in places where no meteorological data are available
methodology technique	Diamond wire saw method for sampling "dirty" ice (heavily loaded with particles and others impurities)	The only way for sampling ice heavily loaded with mineral particles and other impurities
methodology technique	GPS detection method for determining response of ice shelves to tidal pulses	A way to measure the hydrostatic or non hydrostatic effects of tides on ice-shelves
model	Huybrechts' 3D model of the Antarctic ice sheet	Simulation of the Antarctic ice sheet in relation to climate change; prediction of volume and sea level change; interpretation of ice cores
model	Vostok lake ice model for the origin of the deepest part of the Vostok ice core (Antarctica)	Showing how the lake ice present between the lake water and the ice sheet has developed by aggregation and consolidation of small ice crystals nucleated from the lake water (frazil ice)
model	Marine ice production model for quantification of marine ice production in ice shelf rifts	Prediction of ice production in fracture zones (rifts) in ice shelves, preventing the latter of disintegration or strong iceberg calving
model	Climate polar regions, including ocean & sea ice	
strategy	Modeling strategies	Simulations of ice sheets and glaciers for palaeoclimatic reconstructions
<b>3.c) Climate change impact</b>		
model	Model on the relation between the climate, the hydrologie and the chemistry of wet soils	
model	Integrated model for evaluating the effect of climate change on the hydrology and water stocks in hydrological basins	
<b>4. FISHERIES</b>		
map	Thematic map on biological productivity on Lake Tanganyika	To understand fisheries variability and use the lake as a sensible indicator of climate changes
model	Adaptated multidisciplinary ECO-HYDRO model using climate forecasting or scenarios	Managing and forecasting fisheries of Lake Tanganyika and possibly other African Rift Valley lakes
<b>5. MARINE ENVIRONMENT</b>		
<b>5.a) general</b>		
algorithm model	Seasonal evolution of the mesopelagic particulate Ba stock with respiration on organic matter in the twilight zone.	Estimation of organic matter export to the deep sea. Role of the biological pump in response to Climate Change
algorithm model	Seasonally fluctuating proxy signals in biogenic carbonate substrates including the effect of time-base distortion, induced by varying growth rate of the organisms	Reconstruction of historical environmental conditions; Assessment of Global Change (temperature, pollution,...) in the past
algorithm model	Seasonal evolution of the f-ratio (relative importance of new production to total primary production) involving the assimilation rates of various N-nutrients.	Estimation of organic matter export to the deep sea. Role of the biological pump in response to Climate Change
dataset	Contribution to OMEX Phase I and Phase II	
dataset	Contribution to the dataset generated by EROS	
dataset	C inventory	
dataset	C-flux and sea-air exchange	
dataset	Atlantic Ocean: new versus recycled production and nutrient concentration at the NW Iberian Shelf and in the Gulf of Biscay	Input data for f-ratio models; Validation of these models.
dataset	Ascobans	
dataset	1988-2000 time-serie at station 330 of BCZ	
dataset	Long-term dataset on all benthic components (seasonal, monthly information from 1970 until now)	
indicator	Ba-barite as a proxy of export production and twilight zone mineralization of organic matter; Nitrogen Isotope Techniques as a proxy for new production; 234Th-deficit as a proxy for export production.	These compounds are good indicators to estimate organic matter productivity and its export to the deep sea
indicator	Ca, Mg, Sr and d18O in marine carbonates as proxies of SST	These compounds are used in the algorithms/models recalculating global change in the past
indicator methodology, strategy instrument	Socio-economic indicators for different users of the Belgian part of the North Sea, such as fisheries, tourism, recreation, shipping, dredging, sand and gravel exploitation (MARE-DASM: 1998-2002)	<ul style="list-style-type: none"> <li>- Socio-economic indicators for user functions;</li> <li>- Methodology for assessing eco-toxicological effects of accidental oil pollution at sea;</li> <li>- Methodology and economic instrument for recovering ecological damage (ContiGent Validation Method);</li> <li>- Legal assessment of international and national law to recover ecological damage in case of oil pollution accidents at sea</li> </ul>

Scale	Contact persons		Website
regional	Vyverman W. Wilmotte A.	UGent-PAE ULg-CIP	
regional	Lorrain R. Tison J.L.	ULB-GLACIOL	
all	Decleir H. Pattyn F.	VUB-DG	
regional	Souchez R. Tison J.L.	ULB-GLACIOL	
regional	Tison J.L.	ULB-GLACIOL	
regional	Tison J.L.	ULB-GLACIOL	
regional	Huybrechts Ph.	VUB-DG	<a href="http://homepages.vub.ac.be/~phuybrec/research.html">http://homepages.vub.ac.be/~phuybrec/research.html</a>
regional	Souchez R. Tison J.L.	ULB-GLACIOL	
regional	Tison J.L.	ULB-GLACIOL	
regional	Gallée H.	UCL-ASTR	
regional	Decleir H. Pattyn F.	VUB-DG	
	Meire P.	UA-ECOBÉ	
	Smits J.	ULg-CEME	
regional	Descy J.-P./Plisnier P.-D. André L./Plisnier P.-D. Vyverman W./Cocquyt C. Deleersnyder E.	FUNDP-URBO KMMA / MRAC UGent-PAE UCL-ASTR	
regional	Descy J.-P./Plisnier P.-D. André L./Plisnier P.-D. Vyverman W./Cocquyt C. Deleersnyder E.	FUNDP-URBO KMMA / MRAC UGent-PAE UCL-ASTR	
all scales	Baeyens W. Dehairs F.	VUB-ANCH	
all scales	Baeyens W. Dehairs F.	VUB-ANCH	
all scales	Baeyens W. Elskens M.	VUB-ANCH	
	Chou L.	ULB-OCEAN	
	Chou L.	ULB-OCEAN	
	Dehairs F.	VUB-ANCH	
	Dehairs F.	VUB-ANCH	
regional	Baeyens W. Elskens M.	VUB-ANCH	
	Debacker V.	ULg	
	Lancelot C.	ULB-ESA	
regional	Vincx M.	UGent-MARBIOL	
all scales	Baeyens W. Dehairs F.	VUB-ANCH	
all scales	Baeyens W. Dehairs F.	VUB-ANCH	
national / global	Maes F.	UGent	<a href="http://www.maritieminstituut.be">http://www.maritieminstituut.be</a> ; <a href="http://www.ecolas.be">http://www.ecolas.be</a> ; <a href="http://ftbwww.ugent/environmental toxicology">http://ftbwww.ugent/environmental toxicology</a>

## Annex 3: Research products *(continued)*

Type	Name / short description	Application
indicators	Bio-indicators for eutrophication, bio-indicators for oxygen stress, bio-indicators for dredging activities	
map	Limited Atlas of the Belgian Part of the North Sea (2000)	Atlas of user functions
methodology	Tracers of carbon export to the deep sea by the biological pump	Estimation of carbon release in the deep sea, Antarctica
methodology technique	Various chemical analysis and numerical data analysis methodologies	
model	Nitrogen assimilation and regeneration model: Balance of N-fluxes during phytoplankton growth	More accurate estimates of new production including associated uncertainties.
model	SWAMCO: biogeochemical hydrodynamic model with sea-ice interaction	Prediction of CO <sub>2</sub> -uptake in the Southern Ocean and the estimation of atmospheric CO <sub>2</sub> concentration next century
model	Ocean carbon cycle LOCH	
model	Prognostic models of the global ocean carbon cycle	
model	MAR	
model	In MARE-DASM (1998-2002): contribution of MUMM to the development of a predictive model in case of oil pollution in the Belgian part of the North Sea	Improvement of the prediction of oil slicks after accidental pollution at sea
<b>5.b) eutrophication</b>		
dataset	Atmospheric deposition data for the MUMM and for eutrophication models.	Prediction of eutrophication and marine pollution.
indicators	Eutrophication	Algal bloom
model	3D complex model for Phaeosystis blooms	Algal bloom
model	Predictive model of harmful algal blooms in response to nutrient reduction scenarios (OD-MIRO & 3D-MIRO&CO)	Algal bloom
dataset	North Sea and Scheldt estuary nutrient distributions and dynamics	Estimation of productivity in a coastal and estuarine ecosystem; Better understanding of eutrophication
<b>6. NATURE PROTECTION AND BIODIVERSITY</b>		
indicator	STADIV index for quantifying functional status and stability of ecosystems	Estimates of ecological value of grasslands
model	Model for predicting impact of local species extinction for ecosystem processes	Estimating consequences of diversity loss for sustainability
<b>7. WATER</b>		
model	Model on the relation between the climate, the hydrologie and the chemistry of wet soils	
model	Integrated model for evaluating the effect of climate change on the hydrology and water stocks in hydrological basins	
model	EPIC-GRID - catchment hydrological model	Simulation, on a daily time step, of quantitative and qualitative fluxes up to groundwater table and to surface water: prediction of global change impacts on the hydrological cycle

Note: The information in this table is primarily based on the data provided by Belgian scientists during the assessment and integration process.



Scale	Contact persons		Website
regional	Vincx M.	UGent-MARBIOL	
national	Maes F.	UGent	<a href="http://www.martieminstituut.be">www.martieminstituut.be</a>
regional	Dehairs F. André L.	VUB-ANCH KMMA-MRAC	
	Van Grieken R.	UA-MiTAC	
all scales	Baeyens W. Elskens M.	VUB-ANCH	
regional	Lancelot C Goosse H. Dehairs F. André L. Frankignoulle M.	ULB-ESA UCL-ASTR VUB-ANCH KMMA / MRAC ULg-OCEANCHEM	
	Mouchet A.	ULg	
global	Mouchet A.	ULg	
	Gallée H.	UCL-ASTR	
national / global	Maes F.	MUMM	<a href="http://www.martieminstituut.be">www.martieminstituut.be</a> ; <a href="http://www.mumm.ac.be">www.mumm.ac.be</a>
regional	Van Grieken R.	UA-MiTAC	<a href="http://chem-www.uia.ac.be/u/vgrieken/">http://chem-www.uia.ac.be/u/vgrieken/</a>
	Lancelot C.	ULB-ESA	
	Lancelot C./Billen G.	ULB-ESA	
	Lancelot C.	ULB-ESA	
regional	Baeyens W. Brion N.	VUB-ANCH	
national	Nijs I.	UA-PLECO	<a href="http://bio-www.uia.ac.be/bio/pleco/THEMES/themes.html">http://bio-www.uia.ac.be/bio/pleco/THEMES/themes.html</a>
all scales	Nijs I.	UA-PLECO	<a href="http://bio-www.uia.ac.be/bio/pleco/THEMES/themes.html">http://bio-www.uia.ac.be/bio/pleco/THEMES/themes.html</a>
	Meire P.	UA-ECOBE	
	Smitz J.	ULg-CEME	
	Sohier C. Dautrebande S.	FUSAGxUHAGx	ex. of application : <a href="http://earth.esa.int/Disaster/flood/Belgium/Decide_details_algo.htm">http://earth.esa.int/Disaster/flood/Belgium/Decide_details_algo.htm</a>

## Annex 4: From research to policy: examples of programmes and organizations involved

GLOBAL CHANGE RESEARCH PROGRAMMES		Website
Belgium	BELSPO research programmes	<a href="http://belspo.be">http://belspo.be</a>
European Union	Climate Interactions, Resources and Carbon Links to Europe (CIRCLE) European Project on Ice Coring in Antarctica (EPICA) 6th Framework Programme (FP6) Interreg III programme Biodiversity of Microbial Mats in Antarctica (MICROMAT)	<a href="http://www.esf.org/esf_article.php?activity=1&amp;article=85&amp;domain=3">http://www.esf.org/esf_article.php?activity=1&amp;article=85&amp;domain=3</a> <a href="http://fp6.cordis.lu/fp6/home.cfm">http://fp6.cordis.lu/fp6/home.cfm</a> <a href="http://europa.eu.int/comm/regional_policy/interreg3/index_en.htm">http://europa.eu.int/comm/regional_policy/interreg3/index_en.htm</a> <a href="http://www.nerc-bas.ac.uk/public/mlsd/micromat/">http://www.nerc-bas.ac.uk/public/mlsd/micromat/</a>
International	Antarctic benthic deep-sea biodiversity (ANDEEP) Ecology of the Antarctic Ice Zone (SCAR-EASIZ) European Science Foundation (ESF) Transport and chemical transformation of trace constituents in the troposphere over Europe (EUROTRAC) Global Ocean Observing System (GOOS) International Oceanographic Data and Information Exchange (IODE) International programme on biodiversity research (DIVERSITAS) Network for the Detection of Stratospheric Change (NDSC) World Climate Research Programme (WCRP): SPARC, CLIVAR, CliC, ... International Geosphere-Biosphere Programme (IGBP)	<a href="http://www.esf.org/">http://www.esf.org/</a> <a href="http://www.gsf.de/eurotrac/">http://www.gsf.de/eurotrac/</a> <a href="http://ioc.unesco.org/goos/">http://ioc.unesco.org/goos/</a> <a href="http://ioc3.unesco.org/iode/">http://ioc3.unesco.org/iode/</a> <a href="http://www.diversitas-international.org/">http://www.diversitas-international.org/</a> <a href="http://www.ndsc.ncep.noaa.gov/">http://www.ndsc.ncep.noaa.gov/</a> <a href="http://www.wmo.ch/web/wcrp/wcrp-home.html">http://www.wmo.ch/web/wcrp/wcrp-home.html</a> <a href="http://www.igbp.kva.se/cgi-bin/php/frameset.php">http://www.igbp.kva.se/cgi-bin/php/frameset.php</a>
Other	Programme National sur l'Environnement Côtier (PNEC) Signals in Antarctica of past Global Changes (SAGES)	<a href="http://www.cnrs.fr/cw/dossiers/doseau/recher/program/pnec.html">http://www.cnrs.fr/cw/dossiers/doseau/recher/program/pnec.html</a> <a href="http://bsauasc.nbs.ac.uk:8080/~nma/testsite/Science/Programmes/sages/">http://bsauasc.nbs.ac.uk:8080/~nma/testsite/Science/Programmes/sages/</a>

RESEARCH OUTPUTS		Website
<b>Synthesis</b>		
Belgium	BELSPO final reports of research projects, workshops Magazines (Mens, ...) Cluster reports e.g. Carbo-Europe EUROTRAC synthesis reports	<a href="http://belspo.be">http://belspo.be</a> <a href="http://www.carboeurope.org/">http://www.carboeurope.org/</a> <a href="http://www.gsf.de/eurotrac/">http://www.gsf.de/eurotrac/</a>
International	International Geosphere-Biosphere Programme (IGBP) - synthesis reports, proceedings, ...	<a href="http://www.igbp.kva.se/cgi-bin/php/frameset.php">http://www.igbp.kva.se/cgi-bin/php/frameset.php</a>
United Nations	IPCC special / methodology reports	<a href="http://www.ipcc.ch">http://www.ipcc.ch</a>
<b>Scientific assessments</b>		
Belgium	Belgian global change research 1990 – 2002 : Assessment and integration report	<a href="http://belspo.be">http://belspo.be</a>
European Union	Impact of aviation on the atmosphere Research in the Stratosphere The contribution of EASOE and SESAME to our current understanding of the ozone layer Advances in our understanding of the ozone layer during THESEO (1996-2000)	<a href="http://www.ozone-sec.ch.cam.ac.uk">http://www.ozone-sec.ch.cam.ac.uk</a> <a href="http://www.ozone-sec.ch.cam.ac.uk/">http://www.ozone-sec.ch.cam.ac.uk/</a> <a href="http://www.ozone-sec.ch.cam.ac.uk/">http://www.ozone-sec.ch.cam.ac.uk/</a>
Other	Millennium Ecosystem Assessment (MA) European Climate Assessment & Dataset (ECA&D) Global Monitoring for Environment and Security - Global Atmospheric Observations (GMES-GATO) Intergovernmental Panel on Climate Change (IPCC) Scientific Assessments of the scientific, technical and socio-economic information relevant for the understanding of the risk of human-induced climate change Aviation and the Global Atmosphere Antarctic Ice Cap Assessment Towards cleaner air for Europe - Science, Tools and Applications (EUROTRAC 2) UNEP/WMO scientific assessment on O <sub>3</sub> depletion WCRP-SPARC/IOC/GAW Vertical assessment of trends distribution of ozone 1998 IGBP An Integration and Synthesis of a Decade of Tropospheric Chemistry Research A synthesis of a decade of research into global changes that occurred in the Earth System in the past (PAGES). An overview of the role of the ocean carbon cycle in global change (JGOFS) Global Change and the Earth System: A Planet Under Pressure UNECE ICP Forest - the International Co-operative Programme on Assessment and Monitoring of Air Pollution Effects on Forests	<a href="http://www.millenniumassessment.org/en/index.htm">http://www.millenniumassessment.org/en/index.htm</a> <a href="http://www.knmi.nl/samenw/eca/index.html">http://www.knmi.nl/samenw/eca/index.html</a> <a href="http://www.gmes-cca.co.uk/">http://www.gmes-cca.co.uk/</a> <a href="http://www.ipcc.ch/pub/reports.htm">http://www.ipcc.ch/pub/reports.htm</a> <a href="http://www.gsf.de/eurotrac/">http://www.gsf.de/eurotrac/</a> <a href="http://www.al.noaa.gov/WWWHD/pubdocs/Assessment98.html">http://www.al.noaa.gov/WWWHD/pubdocs/Assessment98.html</a> <a href="http://www.wmo.ch/web/arep/gaw/o3reports.html">http://www.wmo.ch/web/arep/gaw/o3reports.html</a> <a href="http://www.igbp.kva.se/cgi-bin/php/frameset.php">http://www.igbp.kva.se/cgi-bin/php/frameset.php</a> <a href="http://www.pages.unibe.ch/">http://www.pages.unibe.ch/</a> <a href="http://www.pages.unibe.ch/">http://www.pages.unibe.ch/</a> <a href="http://www.uib.no/jgofs/jgofs.html">http://www.uib.no/jgofs/jgofs.html</a> <a href="http://www.igbp.kva.se/cgi-bin/php/frameset.php">http://www.igbp.kva.se/cgi-bin/php/frameset.php</a> <a href="http://www.icp-forests.org/Index.htm">http://www.icp-forests.org/Index.htm</a>
<b>Mixed assessments</b>		
Belgium-regional	MIRA-S and MIRA-T	<a href="http://www2.vmm.be">http://www2.vmm.be</a>
Other	North Sea Quality Status report (OSPAR)	<a href="http://www.ospar.org/">http://www.ospar.org/</a>

## Annex 4: From research to policy: examples ... *(continued)*

USERS		Website
<b>International research institutes</b>		
European Union	Joint Research Centre (JRC)	<a href="http://www.jrc.it/">http://www.jrc.it/</a>
Other	International Institute for Applied Systems Analysis (IIASA)	<a href="http://www.iiasa.ac.at/">http://www.iiasa.ac.at/</a>
<b>Public research institutes</b>		
Belgium	Vlaamse Instelling voor Technologisch Onderzoek (VITO)	<a href="http://www.vito.be">http://www.vito.be</a>
	Institut de Conseil et d'Etudes en Développement Durable (ICEDD)	<a href="http://www.icedd.be/icedd/index.html">http://www.icedd.be/icedd/index.html</a>
<b>Platforms</b>		
Belgium-federal	Biodiversity - Platform	<a href="http://www.biodiversity.be/bbpf/">http://www.biodiversity.be/bbpf/</a>
European Union	EPBRS (European Platform on Biodiversity Research Strategy)	<a href="http://www.epbrs.org/">http://www.epbrs.org/</a>
<b>General public</b>		
	Students	
	Teachers	
<b>NGOs</b>		
	Bond Beter Leefmilieu (BBL)	<a href="http://www.bondbeterleefmilieu.be/">http://www.bondbeterleefmilieu.be/</a>
	Inter-Environnement Bruxelles (IEB)	<a href="http://www.ieb.be/">http://www.ieb.be/</a>
	Ligue Belge pour la Protection des Oiseaux	<a href="http://www.protectiondesoiseaux.be/">http://www.protectiondesoiseaux.be/</a>
	Natuurpunt	<a href="http://www.natuurpunt.be/">http://www.natuurpunt.be/</a>
	Royal Society of Zoology Antwerp	<a href="http://www.br.fgov.be/cgi-bin/BIODIV/instit.pl?file=instit.pl&amp;instit_id=63">http://www.br.fgov.be/cgi-bin/BIODIV/instit.pl?file=instit.pl&amp;instit_id=63</a>
	Greenpeace	<a href="http://www.greenpeace.org/">http://www.greenpeace.org/</a>
	World Wildlife Fund (WWF)	<a href="http://www.worldwildlife.org/">http://www.worldwildlife.org/</a>
	The international polar foundation	<a href="http://www.polarfoundation.org">http://www.polarfoundation.org</a>
	ASOC (Antarctic and Southern Ocean Coalition) and its Belgian Partners	<a href="http://www.asoc.org/">http://www.asoc.org/</a>
	European Environmental Bureau	<a href="http://www.eeb.org/">http://www.eeb.org/</a>
<b>Private Sector</b>		
	Energy providers	
	Fisheries	
	private consultancy offices (e.g., 3E, Ecolas, Haecon)	
	SGS Depauw & Stokoe	
	Solvay	
	BioSearch Italia S.P.A.	
	Genencor International bv	
	Merck Sharp & Dohme de Espana	
	Zand extractie en baggermaatschappijen (e.g., Decloedt, NHM)	
<b>Societal organizations</b>		
Belgium	Beroepsfederatie van Belgische invoerders en producenten van zeegranulaten (Zeegra vzw)	
	Rederscentrale	<a href="http://www.rederscentrale.be/">http://www.rederscentrale.be/</a>
	Vlaamse Vissersbond	
European Union	European Dredging Association	<a href="http://www.european-dredging.info/in.html">http://www.european-dredging.info/in.html</a>
<b>Advisory councils</b>		
Belgium-federal	Federal Council for Sustainable Development (FCSD, CFDD-FRDO)	<a href="http://www.belspo.be/frdocfdd/">http://www.belspo.be/frdocfdd/</a>
	Health Council	<a href="http://www.environment.fgov.be/index.html">http://www.environment.fgov.be/index.html</a>
	Belgian National Committee on Antarctic Research	<a href="http://www.naturalsciences.be/amphi/cnbra.htm">http://www.naturalsciences.be/amphi/cnbra.htm</a>
Belgium-regional	Conseil de l'Environnement de la Région Bruxelles-Capitale (CERBC)	
	Conseil Wallon de l'Environnement pour le Développement Durable (CWEDD)	<a href="http://www.cwedd.be/">http://www.cwedd.be/</a>
	MINA Council	<a href="http://www.mina.vlaanderen.be">http://www.mina.vlaanderen.be</a>
	Vision groups of the Colourful Flanders Project	<a href="http://www.kleurrijkvlaanderen.be/showpage.asp?iPageID=3">http://www.kleurrijkvlaanderen.be/showpage.asp?iPageID=3</a>
European Union	European Environmental Advisory Councils (EEAC)	<a href="http://www.eeac-network.org/">http://www.eeac-network.org/</a>
International	Global Biodiversity Information Facility (GBIF)	<a href="http://www.gbif.org/">http://www.gbif.org/</a>
	UN Commission for Sustainable Development (CSD)	<a href="http://www.un.org/esa/sustdev/csd/csd13/csd13.htm">http://www.un.org/esa/sustdev/csd/csd13/csd13.htm</a>
Other	Service de la Recherche, des Etudes et du Traitement de l'Information sur l' Environnement (SERTIE, France)	
<b>Scientific committees</b>		
Belgium-federal	National Global Change Committee of The Royal Academies for Science and the Arts of Belgium (RASAB)	<a href="http://www.kvab.be/">http://www.kvab.be/</a>

## Annex 4: From research to policy: examples ... (continued)

USERS	Website
<b>Scientific committees</b>	
	National Oceanology Committee of The Royal Academies for Science and the Arts of Belgium (RASAB) <a href="http://www.kvab.be/">http://www.kvab.be/</a>
European Union	Scientific Committees of the European Science Foundation (ESF) <a href="http://www.esf.org/">http://www.esf.org/</a> External Advisory Group for the Key Action 'Global Change, Climate and Biodiversity' <a href="http://europa.eu.int/comm/research/fp5/eag-global1.html">http://europa.eu.int/comm/research/fp5/eag-global1.html</a>
International	(a group of experts on) Global Change and the Antarctic (GLOCHANT) <a href="http://www.antcrc.utas.edu.au/scar/">http://www.antcrc.utas.edu.au/scar/</a> Council of Managers of National Antarctic Programs (COMNAP) <a href="http://www.comnap.aq/">http://www.comnap.aq/</a> Intergovernmental Oceanographic Commission (IOC) <a href="http://ioc.unesco.org">http://ioc.unesco.org</a> International Council for the Exploration of the Sea (ICES) <a href="http://www.ices.dk/">http://www.ices.dk/</a> Scientific Committee on Antarctic Research (SCAR) <a href="http://www.scar.org/">http://www.scar.org/</a> Scientific Committee on Oceanic Research (SCOR) <a href="http://www.jhu.edu/~scor/">http://www.jhu.edu/~scor/</a> Scientific Committees of the International Geosphere-Biosphere Programme) (IGBP) <a href="http://www.igbp.kva.se">http://www.igbp.kva.se</a> Subglacial Antarctic Lake Exploration (SALE) <a href="http://salegos-scar.montana.edu/">http://salegos-scar.montana.edu/</a> International Council of Scientific Unions (ICSU) <a href="http://www.icsu.org/">http://www.icsu.org/</a> Group of Experts on the Scientific Aspects of Marine Environmental Protection (GESAMP) <a href="http://gesamp.imo.org/">http://gesamp.imo.org/</a>
Other	Natural Environmental Research Council (NERC, UK) <a href="http://www.nerc.ac.uk/">http://www.nerc.ac.uk/</a> French National Centre for Scientific Research (CNRS, France) <a href="http://www.cnrs.fr/">http://www.cnrs.fr/</a>
<b>Policy preparing fora</b>	
Belgium	Local governments (provinces, city councils, ...) <a href="http://www.nirond.be/nederlands/1_index_nl.html">http://www.nirond.be/nederlands/1_index_nl.html</a> Parliamentary Working Groups <a href="http://www.environment.fgov.be">http://www.environment.fgov.be</a> Belgian Agency for Radiactive Waste and enriched Fissile Material (NIRAS) Co-ordination Committee for International Environmental Policy (CCIM-CCPIE) <a href="http://www.belgium.be/eportal/application?languageParameter=nl&amp;pageid=charterDetailPage&amp;navid=3648">http://www.belgium.be/eportal/application?languageParameter=nl&amp;pageid=charterDetailPage&amp;navid=3648</a> Federal Public Service for Defence <a href="http://www.health.fgov.be">http://www.health.fgov.be</a> <a href="http://www.ciddd.fgov.be/">http://www.ciddd.fgov.be/</a>  Federal Department of the Environment <a href="http://www.belgium.be/eportal/application?languageParameter=en&amp;pageid=charterPodPage&amp;navid=10008">http://www.belgium.be/eportal/application?languageParameter=en&amp;pageid=charterPodPage&amp;navid=10008</a> Interdepartmental Commission for Sustainable Development (CIDD-ICDO) <a href="http://mrv.wallonie.be/dgrne/">http://mrv.wallonie.be/dgrne/</a> Federal Public Service of Sustainable Development <a href="http://www2.vlaanderen.be/ned/sites/economie/afd-nat_nijkdommen_energie/menu.htm">http://www2.vlaanderen.be/ned/sites/economie/afd-nat_nijkdommen_energie/menu.htm</a> <a href="http://www.mina.be/">http://www.mina.be/</a> Direction Générale des Ressources naturelles et de l'Environnement (DGRNE) <a href="http://www.vmm.be/">www.vmm.be/</a> <a href="http://www.vlm.be/Start.htm">http://www.vlm.be/Start.htm</a> Network for Atmospheric Pollution Administration for Natural Resources and Energy  Flemish Environmental Administration (AMINAL) Flemish Environment Agency (VMM) Flemish Land Agency (VLM)
European Union	Directorate General Environment <a href="http://europa.eu.int/comm/dgs/environment/index_en.htm">http://europa.eu.int/comm/dgs/environment/index_en.htm</a> EC Working groups EU Councils European Council Working Party International Environment – Climate Change (WPIE-CC) <a href="http://www.eea.eu.int/">http://www.eea.eu.int/</a> European Environment Agency (EEA)
International	Antarctic Treaty Consultative Meeting (ATCM) <a href="http://www.scar.org/Treaty">http://www.scar.org/Treaty</a> Antarctic Treaty System (ATS) <a href="http://www.asoc.org/general/ats.htm">http://www.asoc.org/general/ats.htm</a> Subsidiary Body on Scientific and Technological Advice of the Convention on Biological Diversity (CBD/SBSTA) <a href="http://www.biodiv.org/">http://www.biodiv.org/</a> Commission of the Convention for the Protection of the Marine Environment of the North-East Atlantic - OSPAR commissie <a href="http://www.ospar.org/">http://www.ospar.org/</a> Committee for Environmental Protection – Madrid Protocol (CEP) <a href="http://www.cep.aq/default.asp?casid=5075">http://www.cep.aq/default.asp?casid=5075</a> International Maritime Organization (IMO) <a href="http://www.imo.org">http://www.imo.org</a> Organisation for Economic Co-operation and Development (OECD) <a href="http://www.oecd.org/">http://www.oecd.org/</a> Subsidiary Body on Scientific and Technological Advice of the United Nations Framework Convention on Climate Change (UNFCC/SUBSTA) <a href="http://www.unfccc.de/">http://www.unfccc.de/</a>
Other	Department of Fisheries in Zambia (DOF) <a href="http://africa.msu.edu/PLEA/tafiri.htm">http://africa.msu.edu/PLEA/tafiri.htm</a> Tanzanian Fisheries Research Institute (TAFIRI) Working groups linked to the implementation of the Biodiversity Convention
<b>Policy instruments (legislation)</b>	
see Annex 5	

**Note:** Examples listed refer to the figure in the introductory chapter (p. 23)

## Annex 5: Policies and regulations related to global change issues

GLOBAL CHANGE ISSUES		Website
<b>Air quality</b>		
United Nations	<p>AGENDA 21</p> <p>Chapter 9 - Protection of the atmosphere</p> <p>Convention on Long-range Transboundary Air Pollution (CLRTAP) (1979)</p> <p>Protocol on Further Reduction of Sulphur Emissions (Oslo Protocol) (1995)</p> <p>Protocol concerning the Control of Nitrogen Oxides or their Transboundary Fluxes (Sofia Protocol) (1988)</p> <p>Protocol concerning the Control of Emissions of Volatile Organic Compounds or their Transboundary Fluxes (Geneva Protocol) (1991)</p> <p>Protocol on Long-term Financing of the Cooperative Programme for Monitoring and Evaluation of the Long-range Transmission of Air Pollutants in Europe (EMEP) (1984)</p> <p>Protocol to Abate Acidification, Eutrophication and Ground-level Ozone (multi-effect protocol - Göteborg Protocol) (1999)</p>	<p><a href="http://www.United Nations.org/esa/sustdev/documents/agenda21/index.htm">http://www.United Nations.org/esa/sustdev/documents/agenda21/index.htm</a></p> <p><a href="http://www.unece.org/env/lrtap/">http://www.unece.org/env/lrtap/</a></p>
European Union	<p>Sixth Environment Action Programme 'Environment 2010: Our future, Our choice'</p> <p>Clean Air For Europe (CAFE) (COM(2001)245)</p> <p>Air Quality Framework Directive (Framework Directive 96/62/EC)</p> <p>The first Daughter Directive relating to limit values for sulphur dioxide, nitrogen dioxide and oxides of nitrogen, particulate matter and lead in ambient air (1999/30/EC)</p> <p>The first Daughter Directive relating to limit values for benzene and carbon monoxide in ambient air (2000/69/EC)</p> <p>The third Daughter Directive relating to ozone (2002/3/EC)</p> <p>Directive on National Emission Ceilings for certain atmospheric pollutants (2001/81/EC)</p>	<p><a href="http://europa.eu.int/comm/environment/newprg/index.htm">http://europa.eu.int/comm/environment/newprg/index.htm</a></p> <p><a href="http://europa.eu.int/comm/environment/air/cale/">http://europa.eu.int/comm/environment/air/cale/</a></p> <p><a href="http://europa.eu.int/comm/environment/air/ambient.htm">http://europa.eu.int/comm/environment/air/ambient.htm</a></p> <p><a href="http://europa.eu.int/comm/environment/air/ceilings.htm">http://europa.eu.int/comm/environment/air/ceilings.htm</a></p>
Belgium-federal	<p>Federal Plan to Control Acidification and Tropospheric Ozone 2000-2003</p> <p>National ozone plan 2004-2007</p>	<p><a href="http://www.environment.fgov.be/Root/settakE.htm">http://www.environment.fgov.be/Root/settakE.htm</a></p>
Belgium-regional	<p>Le Plan wallon de l'Air. Programme d'Action pour la Qualité de l'Air en Région wallonne à l'horizon 2010 (2003)</p> <p>Plan voor structurele verbetering van de luchtkwaliteit en de strijd tegen de opwarming van het klimaat (2002 – 2010) - Brussels-Capital Region</p> <p>Milieubeleidsplan 2003-2007 - Verontreiniging door fotochemische stoffen (Flemish Region)</p>	<p><a href="http://air.wallonie.be/pwa_intro.htm">http://air.wallonie.be/pwa_intro.htm</a></p> <p><a href="http://www.ibgebim.be/nederlands/pdf/Air/PLANAC_complet_nl.pdf">http://www.ibgebim.be/nederlands/pdf/Air/PLANAC_complet_nl.pdf</a></p> <p><a href="http://www.milieubeleidsplan.be/plan/thema_fotochemisch.htm">http://www.milieubeleidsplan.be/plan/thema_fotochemisch.htm</a></p>
<b>Stratospheric ozone</b>		
United Nations	<p>AGENDA 21</p> <p>Chapter 9 - Protection of the atmosphere</p> <p>Vienna Convention for the Protection of the Ozone Layer</p> <p>Montreal Protocol on Substances that deplete the Ozone Layer and its Amendments and Adjustments</p>	<p><a href="http://www.un.org/esa/sustdev/documents/agenda21/index.htm">http://www.un.org/esa/sustdev/documents/agenda21/index.htm</a></p> <p><a href="http://www.unep.org/ozone/treaties.shtml">http://www.unep.org/ozone/treaties.shtml</a></p>
European Union	<p>Regulation (EC) No 2037/2000 on Substances that Deplete the Ozone Layer</p>	<p><a href="http://europa.eu.int/comm/environment/ozone/community_action.htm">http://europa.eu.int/comm/environment/ozone/community_action.htm</a></p>
Belgium-regional	<p>Milieubeleidsplan 2003-2007 - Verdunning van de ozonlaag</p> <p>Le Plan wallon de l'Air. Programme d'Action pour la Qualité de l'Air en Région wallonne à l'horizon 2010 (2003)</p> <p>Plan voor structurele verbetering van de luchtkwaliteit en de strijd tegen de opwarming van het klimaat (2002 – 2010) - Brussels-Capital Region</p>	<p><a href="http://www.milieubeleidsplan.be/plan/_down/thema_ozonlaag.pdf">http://www.milieubeleidsplan.be/plan/_down/thema_ozonlaag.pdf</a></p> <p><a href="http://air.wallonie.be/pwa_intro.htm">http://air.wallonie.be/pwa_intro.htm</a></p> <p><a href="http://www.ibgebim.be/nederlands/pdf/Air/PLANAC_complet_nl.pdf">http://www.ibgebim.be/nederlands/pdf/Air/PLANAC_complet_nl.pdf</a></p>
<b>Climate change</b>		
United Nations	<p>United Nations Framework Convention on Climate Change (UNFCCC)</p> <p>Article 2 - Objectives</p> <p>Article 5 - Research and systematic observation</p> <p>Kyoto Protocol</p> <p>Article 3.2 - Quantified emission limitation and reduction commitments: reduction commitments</p> <p>Article 3.3 - Quantified emission limitation and reduction commitments - demonstrable progress</p> <p>Article 10 - Continuing to advance the implementation of existing commitments</p>	<p><a href="http://www.unfccc.de/">http://www.unfccc.de/</a></p>
European Union	<p>Council Regulation (EEC) N° 2080/92-Community aid scheme for forestry measures in agriculture under Regulation</p> <p>Sixth Environment Action Programme 'Environment 2010: Our future, Our choice'</p> <p>European Climate Change Programme (2000) (COM(2001)580)</p> <p>Monitoring Mechanism of Community CO<sub>2</sub> and other Greenhouse</p>	<p><a href="http://europa.eu.int/comm/environment/climat/aid_schemes.pdf">http://europa.eu.int/comm/environment/climat/aid_schemes.pdf</a></p> <p><a href="http://europa.eu.int/comm/environment/newprg/index.htm">http://europa.eu.int/comm/environment/newprg/index.htm</a></p> <p><a href="http://europa.eu.int/comm/environment/climat/eccp.htm">http://europa.eu.int/comm/environment/climat/eccp.htm</a></p> <p><a href="http://europa.eu.int/comm/environment/climat/greenhouse_monitoring.htm">http://europa.eu.int/comm/environment/climat/greenhouse_monitoring.htm</a></p>
Belgium-federal	<p>National CO<sub>2</sub> programme</p> <p>National Belgian Programme to reduce CO<sub>2</sub> emissions (1994)</p>	<p><a href="http://www.environment.fgov.be/Root/settakE.htm">http://www.environment.fgov.be/Root/settakE.htm</a></p>

## Annex 5: Policies and regulations related to global change issues *(continued)*

GLOBAL CHANGE ISSUES		Website
<b>Climate change</b>		
Belgium-regional	Environmental Policy Plan 1997-2001 - the Flemish CO <sub>2</sub> /RUE policy plan Flemish Climate Policy Programme 2002-2005 Plan d'Environnement pour le Développement Durable en Région wallonne Le Plan wallon de l'Air. Programme d'Action pour la Qualité de l'Air en Région wallonne à l'horizon 2010 (2003)	<a href="http://www2.vlaanderen.be/ned/sites/economie/energie/energiesparen/vlaamsklimaatplan.htm">http://www2.vlaanderen.be/ned/sites/economie/energie/energiesparen/vlaamsklimaatplan.htm</a> <a href="http://air.wallonie.be/pwa_intro.htm">http://air.wallonie.be/pwa_intro.htm</a>
<b>Antarctica</b>		
International	Antarctic Treaty System Environmental Protection to the Antarctic Treaty (Madrid Protocol)	<a href="http://www.scar.org/Treaty/treaty_.htm">http://www.scar.org/Treaty/treaty_.htm</a>
<b>Nature Protection and Biodiversity</b>		
United Nations	AGENDA 21 Chapter 15 - Conservation of biological diversity Convention on Biological Diversity (CBD) Convention on International Trade in Endangered Species of Wild Fauna and Flora (CITES)	<a href="http://www.un.org/esa/sustdev/documents/agenda21/index.htm">http://www.un.org/esa/sustdev/documents/agenda21/index.htm</a> <a href="http://www.biodiv.org/">http://www.biodiv.org/</a> <a href="http://www.cites.org">http://www.cites.org</a>
European Union	Biodiversity Action Plans in the areas of Conservation of Natural Resources, Agriculture, Fisheries, and Development and Economic Co-operation Council Directive 92/43/EEC of 21 May 1992 on the conservation of natural habitats and of wild fauna and flora (Habitats Directive) Ministerial Conference on the Protection of Forests in Europe (MCFPE) Second Ministerial Conference on the Protection of Forests in Europe (Helsinki, 1993) Common Agricultural Policy (CAP) Council Regulation (EC) No 1257/1999 of 17 May 1999 on support for rural development from the European Agricultural Guidance and Guarantee Fund and amending and repealing certain Regulations Sixth Environment Action Programme 'Environment 2010: Our future, Our choice' Thematic strategy on the sustainable use of natural resources	<a href="http://europa.eu.int/comm/environment/biodiversity/index_en.htm">http://europa.eu.int/comm/environment/biodiversity/index_en.htm</a> <a href="http://europa.eu.int/comm/environment/nature/habdir.htm">http://europa.eu.int/comm/environment/nature/habdir.htm</a> <a href="http://www.minconf-forests.net/">http://www.minconf-forests.net/</a> <a href="http://europa.eu.int/scadplus/leg/en/lvb/l60002.htm">http://europa.eu.int/scadplus/leg/en/lvb/l60002.htm</a> <a href="http://europa.eu.int/comm/agriculture/rur/leg/1257_en.pdf">http://europa.eu.int/comm/agriculture/rur/leg/1257_en.pdf</a> <a href="http://europa.eu.int/comm/environment/newprg/">http://europa.eu.int/comm/environment/newprg/</a> <a href="http://europa.eu.int/comm/environment/natres/">http://europa.eu.int/comm/environment/natres/</a>
<b>Water</b>		
United Nations	AGENDA 21 Chapter 18 - Protection of the quality and supply of freshwater resources: application of integrated approaches to the development, management and use of water resources	<a href="http://www.un.org/esa/sustdev/documents/agenda21/index.htm">http://www.un.org/esa/sustdev/documents/agenda21/index.htm</a>
European Union	Water Framework Directive Common Implementation strategy (2000/60/EC) EC Nitrates Directive (91/676/EC)	<a href="http://europa.eu.int/comm/environment/water/index.html">http://europa.eu.int/comm/environment/water/index.html</a>
<b>Marine environment</b>		
United Nations	AGENDA 21 Chapter 17 - Protection of the oceans, all kinds of seas, including enclosed and semi-enclosed seas, and coastal areas and the protection, rational use and development of their living resources United Nations Convention on the Law of the Sea (UNCLOS), art.117 - 120 International Conferences for the protection of the North Sea London Declaration (2 <sup>nd</sup> North Sea Conference) Bergen Declaration (5 <sup>th</sup> North Sea Conference) Convention for the Protection of the Marine Environment of the North-East Atlantic (OSPAR) Strategy to Combat Eutrophication Convention on the Prevention of Marine Pollution by Dumping of Wastes and Other Matter	<a href="http://www.un.org/esa/sustdev/documents/agenda21/index.htm">http://www.un.org/esa/sustdev/documents/agenda21/index.htm</a> <a href="http://www.un.org/Depts/los/index.htm">http://www.un.org/Depts/los/index.htm</a> <a href="http://odin.dep.no/md/nsc/index-b-n-a.html">http://odin.dep.no/md/nsc/index-b-n-a.html</a> <a href="http://www.ospar.org/">http://www.ospar.org/</a> <a href="http://www.ospar.org/eng/html/sap/eutstrat.htm">http://www.ospar.org/eng/html/sap/eutstrat.htm</a> <a href="http://www.imo.org/Conventions/contents.asp?topic_id=258&amp;doc_id=681">http://www.imo.org/Conventions/contents.asp?topic_id=258&amp;doc_id=681</a>
European Union	Sixth Environment Action Programme 'Environment 2010: Our future, Our choice' Towards a strategy to protect and conserve the marine environment	<a href="http://europa.eu.int/comm/environment/newprg/">http://europa.eu.int/comm/environment/newprg/</a> <a href="http://europa.eu.int/eur-lex/en/com/pdf/2002/com2002_0539en01.pdf">http://europa.eu.int/eur-lex/en/com/pdf/2002/com2002_0539en01.pdf</a>
Belgium-federal	Law on the protection of the marine environment under Belgian jurisdiction (MMM)	<a href="http://www.mumm.ac.be/NL/Management/Law/mmm.php">http://www.mumm.ac.be/NL/Management/Law/mmm.php</a>
<b>Land use</b>		
European Union	Integrated Coastal Zone Management (ICZM)	<a href="http://europa.eu.int/comm/environment/iczm/home.htm">http://europa.eu.int/comm/environment/iczm/home.htm</a> <a href="http://europa.eu.int/comm/environment/land_use/index_en.htm">http://europa.eu.int/comm/environment/land_use/index_en.htm</a>
<b>Agriculture and Forestry</b>		
European Union	Sixth Environment Action Programme 'Environment 2010: Our future, Our choice' Soil protection Common Agricultural Policy Monitoring of forests and environmental interactions in the Community Counteracting deterioration of environmental quality in rural areas EC agro-environment directive EC 1257/99 on sustainable practices	<a href="http://europa.eu.int/comm/environment/newprg/index.htm">http://europa.eu.int/comm/environment/newprg/index.htm</a> <a href="http://europa.eu.int/comm/environment/soil/index.htm">http://europa.eu.int/comm/environment/soil/index.htm</a> <a href="http://europa.eu.int/eur-lex/en/lif/ind/en_analytical_index_03.html">http://europa.eu.int/eur-lex/en/lif/ind/en_analytical_index_03.html</a> <a href="http://europa.eu.int/comm/environment/nature/forest-regulations.htm">http://europa.eu.int/comm/environment/nature/forest-regulations.htm</a>

## Annex 5: Policies and regulations related to global change issues *(continued)*

GLOBAL CHANGE ISSUES		Website
<b>Sustainable Development</b>		
United Nations	AGENDA 21 Johannesburg Plan of Implementation	<a href="http://www.un.org/esa/sustdev/documents/agenda21/index.htm">http://www.un.org/esa/sustdev/documents/agenda21/index.htm</a> <a href="http://www.un.org/esa/sustdev/documents/WSSD_POI_PD/English/POIToc.htm">http://www.un.org/esa/sustdev/documents/WSSD_POI_PD/English/POIToc.htm</a>
European Union	European Union Sustainable Development Strategy	<a href="http://europa.eu.int/comm/environment/eussd/index.htm">http://europa.eu.int/comm/environment/eussd/index.htm</a>
Belgium-federal	Federal Plan for Sustainable Development 2000-2004	<a href="http://www.cidd.fgov.be/pub/rapports.stm">http://www.cidd.fgov.be/pub/rapports.stm</a>
Belgium-regional	Flemish Environmental Policy Plans MINA-plan 2 (1997-2001) MINA-plan 3 (2002-2007) Milieubeleidsplan 2003-2007	<a href="http://www.mina.vlaanderen.be">http://www.mina.vlaanderen.be</a>

**Note:** This table provides an overview of policies and regulations in the areas covered by this report. It is primarily based on the data provided by Belgian scientists during the assessment and integration process. In most of these policy areas, Belgian scientists were involved in the policy preparation.

## Annex 6: Belgian research institutions

Institution	Contact	Website
<b>Federal Scientific Institutions</b>		
<b>BIRA/IASB</b>	<b>Belgisch Instituut voor Ruimte-Aëronomie / Institut d'Aéronomie Spatiale de Belgique (Belgian Institute for Space Aeronomy)</b>	de Mazière M., Muller J.-F.
<a href="http://www.bira.be">http://www.bira.be</a>		
<b>IRM/KMI</b>	<b>Institut Royal Météorologique / Koninklijk Meteorologisch Instituut (Royal Meteorological Institute)</b>	De Backer H., Tricot C.
<a href="http://www.meteo.be/IRM-KMI">http://www.meteo.be/IRM-KMI</a>		
<b>IRSNB/KBIN</b>	<b>Institut Royal des Sciences Naturelles de Belgique / Koninklijk Belgisch Instituut voor Natuurwetenschappen (Royal Belgian Institute of Natural Sciences)</b>	
<a href="http://www.naturalsciences.be">http://www.naturalsciences.be</a>		
Invertebrates <b>MUMM</b>	Invertebrates Management Unit of the North Sea Mathematical Models	Grootaert P., Willenz Ph. Pichot G.
<a href="http://www.naturalsciences.be/science/organigram/invertebres">http://www.naturalsciences.be/science/organigram/invertebres</a> <a href="http://www.mumm.ac.be/EN/index.php">http://www.mumm.ac.be/EN/index.php</a>		
<b>KMMA/MRAC</b>	<b>Koninklijk Museum voor Midden-Afrika / Musée Royal d'Afrique Centrale (Royal Museum for Central Africa)</b>	
<a href="http://www.africamuseum.be">http://www.africamuseum.be</a>		
<b>GEO</b>	Geology and Mineralogy	André L.
<a href="http://www.africamuseum.be/research/geology">http://www.africamuseum.be/research/geology</a>		
<b>Universities</b>		
<b>FPMS</b>	<b>Faculté Polytechnique de Mons</b>	
<b>FLUIDMACH</b>	Groupe Mécanique	Passelecq Ch., Hanton J.
<a href="http://www.fpms.ac.be">http://www.fpms.ac.be</a> <a href="http://www.fpms.ac.be/fr/teaching_units/tu_meca_fluides.html">http://www.fpms.ac.be/fr/teaching_units/tu_meca_fluides.html</a>		
<b>FUNDP</b>	<b>Facultés Universitaires Notre-Dame de la Paix</b>	
<b>URBO</b>	Unité de Recherches en Biologie des Organismes	Descy J.-P.
<a href="http://www.fundp.ac.be">http://www.fundp.ac.be</a> <a href="http://www.fundp.ac.be/urbo/index.html">http://www.fundp.ac.be/urbo/index.html</a>		
<b>FUSAGx</b>	<b>Faculté Universitaire des Sciences Agronomiques de Gembloux</b>	
<b>ECOPHYS</b>	Unité de Biologie végétale - Ecophysiology des arbres forestiers	Laitat E.
<a href="http://www.fsagx.ac.be/ecophys/index.htm">http://www.fsagx.ac.be/ecophys/index.htm</a>		
<b>UHAGx</b>	Unité de Hydrologie et Hydraulique agricole	Dautrebande S., Sohier C.
<a href="http://www.cref.be/Recherche/UnitDesc.asp?ldUnit=FUSAGx021300">http://www.cref.be/Recherche/UnitDesc.asp?ldUnit=FUSAGx021300</a>		
<b>KULeuven</b>	<b>Katholieke Universiteit Leuven</b>	
<b>H&amp;EG</b>	Hydrogeology & Engineering Geology	Dassargues A.
<b>PAC</b>	Division for Physical and Analytical Chemistry	Peeters J., Vinckier C.
<b>LFNL</b>	Laboratory fo Forest, Nature and Landscape Research	Van Orshoven J.
<b>LSWM</b>	Laboratory for Soil en Water Management	Feyen J.
<a href="http://www.kuleuven.ac.be">http://www.kuleuven.ac.be</a> <a href="http://www.kuleuven.ac.be/geology/hsg/H&amp;EG/H&amp;EG-intro.html">http://www.kuleuven.ac.be/geology/hsg/H&amp;EG/H&amp;EG-intro.html</a> <a href="http://arhenius.chem.kuleuven.ac.be/fysanal/fysanal_en.html">http://arhenius.chem.kuleuven.ac.be/fysanal/fysanal_en.html</a> <a href="http://www.agr.kuleuven.ac.be/lbh/lbnl/index-eng.htm">http://www.agr.kuleuven.ac.be/lbh/lbnl/index-eng.htm</a> <a href="http://www.agr.kuleuven.ac.be/lbh/lwb">http://www.agr.kuleuven.ac.be/lbh/lwb</a>		
<b>UA</b>	<b>Universiteit Antwerpen</b>	
<b>DECO</b>	Laboratory of Animal Ecology	Mathysen E.
<b>ECOBE</b>	Ecosystem Management Research Group	Meire P., Verheyen R.
<b>EFB</b>	Ecofysiologie en Biochemie	Blust R.
<b>MiTAC</b>	Micro and Trace Analysis Centre	Van Grieken R.
<b>Phar</b>	Laboratory of Biomolecular Mass Spectrometry	Claeys M.
<b>PLECO</b>	Research Group of Plant and Vegetation Ecology	Ceulemans R., Nijls I.
<a href="http://www.uia.ac.be">http://www.uia.ac.be</a> <a href="http://www.uia.ac.be/bio/deco">http://www.uia.ac.be/bio/deco</a> <a href="http://www.uia.ac.be/main.asp?c=">http://www.uia.ac.be/main.asp?c="</a> ECOBE <a href="http://143.129.203.3/nl/onderzoek/dept/bio/efb.htm">http://143.129.203.3/nl/onderzoek/dept/bio/efb.htm</a> <a href="http://www.uia.ac.be/chem/en/index.html">http://www.uia.ac.be/chem/en/index.html</a> <a href="http://www.uia.ac.be/main.asp?c=">http://www.uia.ac.be/main.asp?c="</a> MASSS <a href="http://www.uia.ac.be/bio/pleco">http://www.uia.ac.be/bio/pleco</a>		
<b>UCL</b>	<b>Université catholique de Louvain</b>	
<b>ASTR</b>	Institut d'Astronomie et de Géophysique G. Lemaître	Berger A., Deleersnijder E., Fichefet Th., Schayes G., van Ypersele J.-P.
<a href="http://www.ucl.ac.be">http://www.ucl.ac.be</a> <a href="http://www.astr.ucl.ac.be">http://www.astr.ucl.ac.be</a>		
<b>ECOL</b>	Unité d'Ecologie et de Biogéographie	Le Boulangé E., Baguette M.
<b>EFOR</b>	Unité des Eaux et des Forêts	André P.
<b>GEOG</b>	Unité de Géographie	Geist H., Lambin E., Van Wesemael B.
<a href="http://www.ecol.ucl.ac.be">http://www.ecol.ucl.ac.be</a> <a href="http://www.efor.ucl.ac.be">http://www.efor.ucl.ac.be</a> <a href="http://www.geo.ucl.ac.be/UNITES/GEOG/index.html">http://www.geo.ucl.ac.be/UNITES/GEOG/index.html</a>		
<b>GEOI</b>	Unité de Géologie	Seret G.
<a href="http://www.geo.ucl.ac.be/UNITES/GEOI/index.html">http://www.geo.ucl.ac.be/UNITES/GEOI/index.html</a>		
<b>UGent</b>	<b>Universiteit Gent</b>	
<b>INW</b>	Institute for Nuclear Sciences	Maenhaut W.
<a href="http://www.ugent.be">http://www.ugent.be</a> <a href="http://aiwww.ugent.be/Onderzoeksbeleid/techno2002/EN/WE1-WE08V04.htm">http://aiwww.ugent.be/Onderzoeksbeleid/techno2002/EN/WE1-WE08V04.htm</a>		
<b>ISOFYS</b>	Department of Applied Analytical and Physical Chemistry, Laboratory of Applied Physical Chemistry	Boeckx P, Van Cleemput O.
<a href="http://fltbwww.UGent.be/isofys">http://fltbwww.UGent.be/isofys</a>		
<b>MARBIOL</b>	Marine Biology Section	Vincx M.
<b>OC</b>	Department of Organic Chemistry	Van Langenhove H.
<b>PAE</b>	Protistologie en Aquatische Ecologie	Vyverman W., Cocquyt Ch.
<a href="http://www.marinebiology.ugent.be">http://www.marinebiology.ugent.be</a> <a href="http://fltbwww.ugent.be/departments/index.php?department=LA11">http://fltbwww.ugent.be/departments/index.php?department=LA11</a> <a href="http://aiwww.rug.ac.be/Onderzoeksbeleid/techno2002/NL/WE1-WE11V10.htm">http://aiwww.rug.ac.be/Onderzoeksbeleid/techno2002/NL/WE1-WE11V10.htm</a>		
<b>PLANTECO</b>	Laboratory of Plant Ecology	Lemeur R., Vandewalle I.
<b>PP</b>	Department of Plant Production	Reheul D., Behaeghe T.
<b>RCMG</b>	Renard Centre of Marine Geology	De Batist M.
<b>SOILMAN</b>	Department of Soil Management and Soil Care	Hofman G.
<a href="http://allserv.rug.ac.be/planteco">http://allserv.rug.ac.be/planteco</a> <a href="http://fltbwww.UGent.be/vakgroepen/index.php?vakgroep=LA02">http://fltbwww.UGent.be/vakgroepen/index.php?vakgroep=LA02</a> <a href="http://allserv.rug.ac.be/~jphenrie">http://allserv.rug.ac.be/~jphenrie</a> <a href="http://www.soilman.ugent.be">http://www.soilman.ugent.be</a>		



## Annex 6: Belgian research institutions *(continued)*

Institution	Contact	Website
<b>Universities</b>		
<b>ULB</b>	<b>Université Libre de Bruxelles</b>	
BIOMAR	Centre Interuniversitaire de Biologie Marine	<a href="http://www.ulb.ac.be">http://www.ulb.ac.be</a>
ESA	Ecologie des Systèmes Aquatiques	<a href="http://www.ulb.ac.be/sciences/biomar/index.html">http://www.ulb.ac.be/sciences/biomar/index.html</a>
GLACIOL	Glaciologie Polaire	<a href="http://www.ulb.ac.be/rech/inventaire/unites/ULB115.html">http://www.ulb.ac.be/rech/inventaire/unites/ULB115.html</a>
GMMA	Groupe de Microbiologie des Milieux Aquatiques	<a href="http://www.ulb.ac.be/rech/inventaire/unites/ULB182.html">http://www.ulb.ac.be/rech/inventaire/unites/ULB182.html</a>
OCEAN	Laboratoire d'Océanographie Chimique et Géochimie des Eaux	<a href="http://www.ulb.ac.be/rech/inventaire/unites/ULB115.html">http://www.ulb.ac.be/rech/inventaire/unites/ULB115.html</a>
		<a href="http://www.ulb.ac.be/sciences/dste/ocean">http://www.ulb.ac.be/sciences/dste/ocean</a>
SPECAT	Unité de Spectroscopie de l'Atmosphère	<a href="http://www.ulb.ac.be/rech/inventaire/unites/ULB587.html">http://www.ulb.ac.be/rech/inventaire/unites/ULB587.html</a>
<b>ULg</b>	<b>Université de Liège</b>	<a href="http://www.ulg.ac.be">http://www.ulg.ac.be</a>
BOT	Institut de Botanique	<a href="http://www.ulg.ac.be/facsc">http://www.ulg.ac.be/facsc</a>
CEME	Centre d'Etude et de Modélisation de l'Environnement	
CIP	Centre d'Ingénierie des Protéines	<a href="http://www.ulg.ac.be/cingprot">http://www.ulg.ac.be/cingprot</a>
ECOHYD	Unité d'Ecohydrodynamique	<a href="http://modb.oce.ulg.ac.be/ECOHYD/welcome.htm">http://modb.oce.ulg.ac.be/ECOHYD/welcome.htm</a>
GIRPAS	Groupe Infrarouge de Physique Atmosphérique et Solaire	<a href="http://sunset.astro.ulg.ac.be/girpas/girpasf.html#CONT">http://sunset.astro.ulg.ac.be/girpas/girpasf.html#CONT</a>
LGIH	Laboratory of Engineering Geology, Hydrogeology and Geophysical Prospecting	<a href="http://www.lgih.ulg.ac.be">http://www.lgih.ulg.ac.be</a>
LPAP	Laboratoire de Physique Atmosphérique et Planétaire	<a href="http://www.astro.ulg.ac.be/GRech/lpap_f.html">http://www.astro.ulg.ac.be/GRech/lpap_f.html</a>
OCEANBIO	Laboratoire d'Océanologie	<a href="http://www.ulg.ac.be/oceanbio">http://www.ulg.ac.be/oceanbio</a>
OCEANCHEM	Chemical Oceanography Unit	<a href="http://www.ulg.ac.be/oceanbio/co2">http://www.ulg.ac.be/oceanbio/co2</a>
URAP	Unité de Recherche Argiles et Paléoclimats	<a href="http://www.ulg.ac.be/urap">http://www.ulg.ac.be/urap</a>
<b>UMH</b>	<b>Université de Mons-Hainaut</b>	<a href="http://www.umh.ac.be">http://www.umh.ac.be</a>
FS	Service d'Informatique Générale	<a href="http://sinfo.umh.ac.be/equipes.htm">http://sinfo.umh.ac.be/equipes.htm</a>
<b>VUB</b>	<b>Vrije Universiteit Brussel</b>	<a href="http://www.vub.ac.be">http://www.vub.ac.be</a>
ANCH	Laboratorium voor Analytische Scheikunde	<a href="http://we.vub.ac.be/dsch">http://we.vub.ac.be/dsch</a>
DG	Department of Geography	<a href="http://www.vub.ac.be/DGGF">http://www.vub.ac.be/DGGF</a>
ECOL	Laboratorium voor Ecologie en Systematiek	<a href="http://we.vub.ac.be/~ecol">http://we.vub.ac.be/~ecol</a>
<b>Regional Institutes</b>		
<b>CELINE/IRCEL</b>	<b>Cellule Interrégionale de l'Environnement / Intergewestelijke Cel voor het Leefmilieu (Interregional Cell for the Environment)</b>	<a href="http://www.irceline.be">http://www.irceline.be</a>
<b>CLO</b>	<b>Centrum voor Landbouwkundig Onderzoek (Agricultural Research Centre)</b>	<a href="http://www.clo.fgov.be">http://www.clo.fgov.be</a>
DFE	Departement voor Fytotechnie en Ecofysiologie (Department of Crop Husbandry and Ecophysiology)	<a href="http://www.clo.fgov.be/dfe">http://www.clo.fgov.be/dfe</a>
<b>IBW</b>	<b>Instituut voor Bosbouw en Wildbeheer (Belgian Institute for Forestry and Game Management)</b>	<a href="http://www.ibw.vlaanderen.be">http://www.ibw.vlaanderen.be</a>
<b>VITO</b>	<b>Vlaamse Instelling voor Technologisch Onderzoek (Flemish Institute for Technological Research)</b>	<a href="http://www.vito.be/english">http://www.vito.be/english</a>
TAP	Remote Sensing and Atmospheric Processes	<a href="http://www.vito.be/milieu/teledetectie.htm">http://www.vito.be/milieu/teledetectie.htm</a>

**Note:** The institutions listed here are those which are mentioned in this report

## Annex 7: Acronyms and abbreviations

Name	Description	Website
<b>ACE</b>	Atmospheric Chemistry Experiment (ATMOS)	<a href="http://www.ace.uwaterloo.ca/">http://www.ace.uwaterloo.ca/</a>
<b>ACE-2 and -3</b>	Aerosol Characterisation Experiments 2 and 3 (IGBP-IGAC)	
<b>ACSYS</b>	Arctic Climate System Study	<a href="http://acsys.npolar.no/">http://acsys.npolar.no/</a>
<b>ACVT</b>	Atmospheric Chemistry Validation Team	<a href="http://www.sciamachy-validation.org/sv/reindex.html?acvt.html">http://www.sciamachy-validation.org/sv/reindex.html?acvt.html</a>
<b>AD</b>	Anno Dominus	
<b>ADEOS</b>	Advanced Earth Observing Satellite	<a href="http://www.eorc.nasda.go.jp/ADEOS/">www.eorc.nasda.go.jp/ADEOS/</a>
<b>AGCM</b>	Atmospheric General Circulation Model	<a href="http://www.metoffice.com">www.metoffice.com</a>
<b>AGISM</b>	Antarctic and Greenland Ice Sheets Model	
<b>AMICS</b>	Antarctic ice-sheet dynamics and climatic change: Modelling and Ice Composition Studies	<a href="http://gopher.ulb.ac.be/~fpattyn/amics/welcome.html">http://gopher.ulb.ac.be/~fpattyn/amics/welcome.html</a>
<b>AMINAL</b>	Flemish Environmental Administration (Administratie Milieu-, Natuur-, Land- en Waterbeheer van het Ministerie van de Vlaamse Gemeenschap)	<a href="http://www.mina.be/">http://www.mina.be/</a>
<b>AMORE</b>	Advanced modelling and research on eutrophication	
<b>ANRE</b>	Flemish Administration for Natural Resources and Energy	<a href="http://www2.vlaanderen.be/ned/sites/economie/energie/">http://www2.vlaanderen.be/ned/sites/economie/energie/</a>
<b>ANTAR</b>	Belgian Scientific Research Programme on the Antarctic	<a href="http://www.belspo.be/antar/">http://www.belspo.be/antar/</a>
<b>AOGCM</b>	Atmosphere-Ocean General Circulation Model	<a href="http://www.metoffice.com/research/hadleycentre/models/modeltypes.html">www.metoffice.com/research/hadleycentre/models/modeltypes.html</a>
<b>AOTn</b>	Accumulated ozone concentrations in excess of n ppbv	
<b>AR4</b>	4 <sup>th</sup> Assessment Report of the IPCC	<a href="http://www.ipcc.ch">www.ipcc.ch</a>
<b>ASOC</b>	Antarctic and Southern Ocean Coalition	<a href="http://www.asoc.org/">http://www.asoc.org/</a>
<b>ASPECTS</b>	Atmosphere-Soil-Plant Exchange of Carbon in Temperate Sylvae	
<b>ATCM</b>	Antarctic Treaty Consultative Meeting	<a href="http://www.scar.org/Treaty">http://www.scar.org/Treaty</a>
<b>ATLAS</b>	Atmospheric Laboratory for Applications and Science	<a href="http://www.gfcc.msfc.nasa.gov/atlas.html">http://www.gfcc.msfc.nasa.gov/atlas.html</a>
<b>ATMOS</b>	Atmospheric Trace Molecule Spectroscopy	<a href="http://atmos.jpl.nasa.gov/atmos">http://atmos.jpl.nasa.gov/atmos</a>
<b>AVHRR</b>	Advanced Very High Resolution Radiometer	
<b>BASCOE</b>	Belgian Assimilation System of Chemical Observations from ENVISAT	<a href="http://www.bascoe.oma.be/index.html">http://www.bascoe.oma.be/index.html</a>
<b>BBL</b>	Bond Beter Leefmilieu Vlaanderen vzw (Belgium)	<a href="http://www.bondbeterleefmilieu.be/">http://www.bondbeterleefmilieu.be/</a>
<b>BCZ</b>	Belgian coastal zone	
<b>BEDMAP</b>	Antarctic Bed Mapping	<a href="http://www.antarctica.ac.uk/aedc/bedmap/">http://www.antarctica.ac.uk/aedc/bedmap/</a>
<b>BELCANTO</b>	Belgian research on Carbon uptake in the Antarctic Ocean	<a href="http://www.ulg.ac.be/oceanbio/antar/antar5/frame3/objectives.htm">http://www.ulg.ac.be/oceanbio/antar/antar5/frame3/objectives.htm</a>
<b>BELEUROS</b>	European Operational Smog Model adapted to Belgium	<a href="http://www.beleuros.be/">http://www.beleuros.be/</a>
<b>BELFOR</b>	Belgian Forest ecosystems	<a href="http://www.vito.be/belfor/">http://www.vito.be/belfor/</a>
<b>BELSP0</b>	Belgian Federal Science Policy Office	<a href="http://www.belspo.be">http://www.belspo.be</a>
<b>BIBEX</b>	Biomass Burning Experiment	<a href="http://www.mpch-mainz.mpg.de/bibex.html">http://www.mpch-mainz.mpg.de/bibex.html</a>
<b>BIOGEST</b>	Biogas Transfer in Estuaries	<a href="http://www.ulg.ac.be/oceanbio/biogest/">http://www.ulg.ac.be/oceanbio/biogest/</a>
<b>BP</b>	Before Present	
<b>CAFE</b>	Clean Air For Europe	<a href="http://europa.eu.int/comm/environment/air/cale/">http://europa.eu.int/comm/environment/air/cale/</a>
<b>CALMARS</b>	Calcareous Marine Skeletons	<a href="http://www.vub.ac.be/calmar/">http://www.vub.ac.be/calmar/</a>
<b>CARAIB</b>	Carbon Assimilation In the Biosphere	<a href="http://gain.unh.edu/Structure/Intercomparison/EMDI/models/caraib.html">http://gain.unh.edu/Structure/Intercomparison/EMDI/models/caraib.html</a>
<b>CASTEC</b>	Carbon Sequestration in Terrestrial Ecosystems	<a href="http://allserv.rug.ac.be/~cvclemp/">http://allserv.rug.ac.be/~cvclemp/</a>
<b>CAT</b>	Constituent-oriented Age Theory	
<b>CBD</b>	Convention on Biological Diversity	<a href="http://www.biodiv.org/">http://www.biodiv.org/</a>
<b>CCBS</b>	Committee on Capacity Building in Science	<a href="http://www.icsu.org/1_icsuinscience/CAPA.html">http://www.icsu.org/1_icsuinscience/CAPA.html</a>
<b>CCCC</b>	Role of Oceanic Production and Dissolution of Calcium Carbonate in Climate Change	<a href="http://www.ulb.ac.be/sciences/dste/ocean/carbonate/indexW.html">http://www.ulb.ac.be/sciences/dste/ocean/carbonate/indexW.html</a>
<b>CCN</b>	Cloud Condensation Nuclei	
<b>CCPIE-CCIM</b>	Co-ordination Committee for International Environmental Policy (Comité de Coordination de la Politique Internationale de l'Environnement - Coördinatiecomité Internationaal Milieubeleid)	<a href="http://www.environment.fgov.be">http://www.environment.fgov.be</a>
<b>CDM</b>	Clean Development Mechanism (UNFCCC)	<a href="http://cdm.unfccc.int/">http://cdm.unfccc.int/</a>
<b>CDR</b>	Committee on Disaster Reduction	<a href="http://www.icsu.org/about/structure/IIb/cdr.html">http://www.icsu.org/about/structure/IIb/cdr.html</a>
<b>CEC</b>	Cation Exchange Capacity	
<b>CEOS</b>	Committee on Earth Observation Satellites	<a href="http://www.ceos.org/">http://www.ceos.org/</a>
<b>CEP</b>	Committee of Environmental Protection	<a href="http://www.cep.aq/default.asp?casid=5075">http://www.cep.aq/default.asp?casid=5075</a>
<b>CERBC-RLBHG</b>	Environmental Council of the Region of Brussels Capital (Conseil de l'Environnement de la Région de Bruxelles-Capitale - Raad voor het Leefmilieu van het Brussels Hoofdstedelijk Gewest)	<a href="http://www.cerbc.be/FR/frame_tt.htm">http://www.cerbc.be/FR/frame_tt.htm</a>
<b>CFC</b>	Chlorofluorocarbon	
<b>CFDD-FRDO</b>	Federal Council for Sustainable Development (Conseil Fédéral du Développement Durable - Federale Raad voor Duurzame Ontwikkeling)	<a href="http://www.belspo.be/frdocfdd/">http://www.belspo.be/frdocfdd/</a>
<b>CGCM</b>	Coupled General Circulation Model	<a href="http://www.ccmma.bc.ec.gc.ca/models/cgcm1.shtml">http://www.ccmma.bc.ec.gc.ca/models/cgcm1.shtml</a>
<b>CGCM1</b>	First Generation Coupled General Circulation Model	<a href="http://www.ccmma.bc.ec.gc.ca/models/cgcm1.shtml">http://www.ccmma.bc.ec.gc.ca/models/cgcm1.shtml</a>
<b>CIDD-ICDO</b>	Commission Interdépartementale du Développement Durable-Interdepartementale Commissie Duurzame Ontwikkeling (Interdepartmental Commission for Sustainable Development)	<a href="http://www.cidd.fgov.be/">http://www.cidd.fgov.be/</a>
<b>CIRA</b>	COSPAR International Reference Atmosphere	<a href="http://badc.nerc.ac.uk/data/cira/">http://badc.nerc.ac.uk/data/cira/</a>
<b>CIRCLE</b>	Climate Interactions, Resources and Carbon Links to Europe	<a href="http://www.ipy.org/concept/ideas/national/idea080.pdf">www.ipy.org/concept/ideas/national/idea080.pdf</a>
<b>CITES</b>	Convention on International Trade in Endangered Species of Wild Fauna and Flora	<a href="http://www.cites.org/">http://www.cites.org/</a>
<b>cliC</b>	Climate and Cryosphere	<a href="http://clm.npolar.no/">http://clm.npolar.no/</a>
<b>CLIMBEL</b>	Climate change and instruments for emissions abatement in Belgium : an interdisciplinary analysis	<a href="http://www.core.ucl.ac.be/climneg/Home.htm">http://www.core.ucl.ac.be/climneg/Home.htm</a>
<b>CLIMLAKE</b>	Climate variability as recorded in Lake Tanganyika	<a href="http://www.fundp.ac.be/urbo/climlake_gb.html">http://www.fundp.ac.be/urbo/climlake_gb.html</a>
<b>CLIMNEG</b>	Climate change, international negotiations and Belgian strategies	<a href="http://www.climneg.be">http://www.climneg.be</a>
<b>CLIMOD</b>	Climate Modelling	<a href="http://www.climate.be/popwork/introclim.html">http://www.climate.be/popwork/introclim.html</a>
<b>CLIO</b>	Coupled Large-scale Ice Ocean	<a href="http://www.astr.ucl.ac.be/tools/clio.html">http://www.astr.ucl.ac.be/tools/clio.html</a>
<b>CLIVAR</b>	Climate variability and predictability	<a href="http://www.clivar.org/">http://www.clivar.org/</a>
<b>CLO</b>	Agricultural Research Centre of the Flemish Community (Centrum voor Landbouwkundig Onderzoek)	<a href="http://www.clo.fgov.be/">www.clo.fgov.be/</a>
<b>CLRTAP</b>	Convention on Long-Range Transboundary Air Pollution	<a href="http://www.unece.org/env/lrtap/">http://www.unece.org/env/lrtap/</a>

## Annex 7: Acronyms and abbreviations (continued)

Name	Description	Website
<b>CMDL</b>	Climate Monitoring and Diagnostics Laboratory	<a href="http://www.cmdl.noaa.gov/">http://www.cmdl.noaa.gov/</a>
<b>CMLAG</b>	Ministry of Small Traders and Agriculture (Belgium)	<a href="http://cmlag.fgov.be/">http://cmlag.fgov.be/</a>
<b>CMS</b>	Convention on the Conservation of Migratory Species	<a href="http://www.unep-wcmc.org/cms/">http://www.unep-wcmc.org/cms/</a>
<b>CNRS</b>	French National Centre for Scientific Research (Centre National de la Recherche Scientifique)	<a href="http://www.cnrs.fr/">http://www.cnrs.fr/</a>
<b>CODATA</b>	Committee on Data for Science and Technology	<a href="http://www.icsu.org/about/structure/IIb/codata.html">http://www.icsu.org/about/structure/IIb/codata.html</a>
<b>COPs</b>	Conference of the Parties	<a href="http://unfccc.int/cop3/">http://unfccc.int/cop3/</a>
<b>CORINAIR</b>	Core Inventory of Air emissions	<a href="http://etc-ae.eionet.eu.int/etc-ae/index.htm">http://etc-ae.eionet.eu.int/etc-ae/index.htm</a>
<b>COSPAR</b>	Committee on Space Research	<a href="http://www.cosparhq.org/">http://www.cosparhq.org/</a>
<b>COST</b>	European Co-operation in the field of Scientific and Technical Research	<a href="http://cost.cordis.lu/src/home.cfm">http://cost.cordis.lu/src/home.cfm</a>
<b>CRA</b>	Agricultural Research Centre of the Walloon Region (Centre Wallon de Recherches Agronomiques)	<a href="http://www.cra.wallonie.be/">http://www.cra.wallonie.be/</a>
<b>CSA</b>	Canadian Space Agency	<a href="http://www.space.gc.ca/asc/eng/default.asp">http://www.space.gc.ca/asc/eng/default.asp</a>
<b>CSIRO</b>	Commonwealth Scientific and Industrial Research Organisation (Australia)	<a href="http://www.csiro.au/">http://www.csiro.au/</a>
<b>CSM</b>	Climate System Model	
<b>CWEDD</b>	Walloon Environmental Council for Sustainable Development (Conseil Wallon de l'Environnement pour le Développement Durable)	<a href="http://environnement.wallonie.be/cgi/dgme/plateforme_dgme/generateur/sites/modules_ntl/visiteur/cwedd/index-2.html">http://environnement.wallonie.be/cgi/dgme/plateforme_dgme/generateur/sites/modules_ntl/visiteur/cwedd/index-2.html</a>
<b>DGRNE</b>	General Directorate of Natural Resources and the Environment of Wallony (Direction Générale des Ressources Naturelles et de l'Environnement)	<a href="http://mrw.wallonie.be/dgme/">http://mrw.wallonie.be/dgme/</a>
<b>DGTRE</b>	General Directorate for Technology, Research and Energy of Wallony (Direction Générale des Technologies, de la Recherche et de l'Energie)	<a href="http://mrw.wallonie.be/dgtre/">mrw.wallonie.be/dgtre/</a>
<b>DIVERSITAS</b>	an international programme of biodiversity science	<a href="http://www.diversitas-international.org/">http://www.diversitas-international.org/</a>
<b>DM</b>	Dry Matter	
<b>DML</b>	Dronning Maud Land	
<b>DMS</b>	Dimethyl Sulphide	
<b>DNA</b>	Deoxyribonucleic Acid	
<b>DOAS</b>	Differential Optical Absorption Spectroscopy	
<b>DOE</b>	Department of Energy (USA)	<a href="http://www.doe.gov/engine/content.do">http://www.doe.gov/engine/content.do</a>
<b>DSCD</b>	Differential Slant Column Density	
<b>DU</b>	Dobson Unit	
<b>DYE 3</b>	Icecore Greenland	
<b>6EAP</b>	Sixth Environment Action Programme (EU)	<a href="http://europa.eu.int/comm/environment/newprg/">http://europa.eu.int/comm/environment/newprg/</a>
<b>EASOE</b>	European Arctic Stratospheric Ozone Experiment	<a href="http://badc.nerc.ac.uk/data/easoe/">http://badc.nerc.ac.uk/data/easoe/</a>
<b>EC</b>	European Commission	<a href="http://europa.eu.int/comm/index_en.htm">http://europa.eu.int/comm/index_en.htm</a>
<b>EC</b>	Electrical Conductivity	
<b>ECA&amp;D</b>	European Climate Assessment & Dataset	<a href="http://www.knmi.nl/samenw/eca/index.html">http://www.knmi.nl/samenw/eca/index.html</a>
<b>ECBILT</b>	Atmospheric model built at the KNMI (the Netherlands)	<a href="http://www.knmi.nl/onderzk/CKO/doc/ecbilt/ecbilt.html">http://www.knmi.nl/onderzk/CKO/doc/ecbilt/ecbilt.html</a>
<b>ECHAM4</b>	Current version of the climate model developed from the ECMWF atmospheric model and a comprehensive parameterisation package developed at Hamburg	<a href="http://ipcc-ddc.cru.uea.ac.uk/cru_data/examine/echam4_info.html">http://ipcc-ddc.cru.uea.ac.uk/cru_data/examine/echam4_info.html</a>
<b>ECO-HYDRO</b>	Eco-hydrodynamic model	
<b>ECMWF</b>	European Centre for Medium range Weather Forecasts	<a href="http://www.ecmwf.int/">http://www.ecmwf.int/</a>
<b>EEA</b>	European Environment Agency	<a href="http://www.eea.eu.int/">http://www.eea.eu.int/</a>
<b>EEAC</b>	European Environmental Advisory Councils	<a href="http://www.eaac-network.org/">http://www.eaac-network.org/</a>
<b>EEB</b>	European Environmental Bureau	<a href="http://www.eeb.org">http://www.eeb.org</a>
<b>EF</b>	Emission Factor	
<b>EFISCEN</b>	European Forest Information Scenario model	<a href="http://agrifor.ac.uk/hb/4c3701607bdc93fcc662fc89bf3bdb2.html">http://agrifor.ac.uk/hb/4c3701607bdc93fcc662fc89bf3bdb2.html</a>
<b>EFOBEL</b>	Evolution des Forêts Belges - computing model of carbon sequestration in forests	<a href="http://www.bib.fsagx.ac.be/library/base/text/v8n1/27.pdf">http://www.bib.fsagx.ac.be/library/base/text/v8n1/27.pdf</a>
<b>EISMINT</b>	European Ice Sheet Modelling Initiative (EISMINT)	<a href="http://www.esf.org/eismint">http://www.esf.org/eismint</a>
<b>EMEP</b>	Co-operative programme for monitoring and evaluation of the long-range transmissions of air pollutants in Europe (CLRTAP)	<a href="http://www.emep.int/">http://www.emep.int/</a>
<b>EMPA</b>	Swiss Federal Laboratories for Materials Testing and Research	<a href="http://www.empa.ch/plugin/template/empa/704/*/--/l=1">http://www.empa.ch/plugin/template/empa/704/*/--/l=1</a>
<b>ENSO</b>	El Niño Southern Oscillation	
<b>ENSO-CHILI</b>	A continuous holocene record of ENSO variability in Southern Chile	<a href="http://allserv.rug.ac.be/~fcharlet/ENSO_chile.htm">http://allserv.rug.ac.be/~fcharlet/ENSO_chile.htm</a>
<b>ENVISAT</b>	Environmental Satellite	<a href="http://envisat.esa.int/">http://envisat.esa.int/</a>
<b>EORCU</b>	European Ozone Research Coordinating Unit	<a href="http://www.ozone-sec.ch.cam.ac.uk/">http://www.ozone-sec.ch.cam.ac.uk/</a>
<b>EPB</b>	European Polar Board	<a href="http://www.esf.org">http://www.esf.org</a>
<b>EPBRS</b>	European Platform for Biodiversity Research Strategy	<a href="http://www.bioplatform.info/EPBRS.htm">http://www.bioplatform.info/EPBRS.htm</a>
<b>EPICA</b>	European Project for Ice Coring in Antarctica	<a href="http://www.esf.org/esf_article.php?activity=1&amp;article=85&amp;domain=3">http://www.esf.org/esf_article.php?activity=1&amp;article=85&amp;domain=3</a>
<b>EPIC-GRID</b>	a catchment hydrological model	<a href="http://styx.esrin.esa.it/cliff/Partners/UnivGemb.html">http://styx.esrin.esa.it/cliff/Partners/UnivGemb.html</a>
<b>ERA</b>	European Research Area	<a href="http://europa.eu.int/comm/research/era/index_en.html">http://europa.eu.int/comm/research/era/index_en.html</a>
<b>EROS</b>	European River Ocean System	
<b>ERS-2</b>	European Remote Sensing Satellite-2	
<b>ESA</b>	European Space Agency	<a href="http://www.esa.int">http://www.esa.int</a>
<b>ESAC</b>	Experimental study of atmospheric changes	<a href="http://www.oma.be/ESACII/Home.html">www.oma.be/ESACII/Home.html</a>
<b>ESF</b>	European Science Foundation	<a href="http://www.esf.org">http://www.esf.org</a>
<b>ESM</b>	Earth System Model	
<b>ESSP</b>	Earth System Science Partnership	<a href="http://www.ess-p.org/">http://www.ess-p.org/</a>
<b>EU</b>	European Union	<a href="http://europa.eu.int/">http://europa.eu.int/</a>
<b>EUMETSAT</b>	European Organisation for the Exploitation of Meteorological Satellites	<a href="http://www.eumetsat.de/">www.eumetsat.de/</a>
<b>EURECA</b>	European Retrievable Carrier	<a href="http://www.esa.int">http://www.esa.int</a>
<b>EUREKA</b>	pan-European network for market-oriented, industrial R&D	<a href="http://www.eureka.be">http://www.eureka.be</a>
<b>EUROCORES</b>	ESF Collaborative Research Programmes	<a href="http://www.esf.org/">http://www.esf.org/</a>
<b>EUROS</b>	European Operational Smog model	
<b>EUROTRAC</b>	The EUREKA project on the transport and chemical transformation of trace constituents in the troposphere over Europe	<a href="http://www.gsf.de/eurotrac/">http://www.gsf.de/eurotrac/</a>
<b>EUROTRAC-AEROSOL</b>	Composition and Size Evolution of the Secondary Aerosol	<a href="http://aerosol.web.psi.ch/">http://aerosol.web.psi.ch/</a>

## Annex 7: Acronyms and abbreviations *(continued)*

Name	Description	Website
<b>EUROTRAC-LACTOZ</b>	Laboratory Studies of Chemistry Related to Tropospheric Ozone	
<b>FAO</b>	Food and Agriculture Organization of the United Nations	<a href="http://www.fao.org/">www.fao.org/</a>
<b>FIRS</b>	Forest Information from Remote Sensing	<a href="http://www.vtt.fi/tte/research/tte1/tte14/proj/firs/">http://www.vtt.fi/tte/research/tte1/tte14/proj/firs/</a>
<b>FNRS</b>	National Fund for Scientific Research of the French Community (Fonds National de la Recherche Scientifique)	<a href="http://www.fnrs.be">http://www.fnrs.be</a>
<b>FP</b>	Framework Programme (EU)	
<b>FP6</b>	Sixth Framework Programme (EU)	<a href="http://fp6.cordis.lu/fp6/home.cfm">http://fp6.cordis.lu/fp6/home.cfm</a>
<b>FTIR</b>	Fourier Transform Infrared	
<b>FWO</b>	Fund for Scientific Research of Flanders (Fonds voor Wetenschappelijk Onderzoek - Vlaanderen)	<a href="http://sun.fwo.be">http://sun.fwo.be</a>
<b>GBIF</b>	Global Biodiversity Information Facility	<a href="http://www.gbif.org">http://www.gbif.org</a>
<b>GCM</b>	General Circulation Model	
<b>GEISA</b>	Management and Study of Atmospheric Spectroscopic Information (Gestion et Etude des Informations Spectroscopiques Atmosphériques)	<a href="http://ara.lmd.polytechnique.fr/public/products/GEISA/alexei_index.html">http://ara.lmd.polytechnique.fr/public/products/GEISA/alexei_index.html</a>
<b>GESAMP</b>	Group of Experts on the Scientific Aspects of Marine Environmental Protection	<a href="http://gesamp.imo.org/">http://gesamp.imo.org/</a>
<b>GFDL</b>	Geophysical Fluid Dynamics Laboratory	<a href="http://www.gfdl.gov/">http://www.gfdl.gov/</a>
<b>GHG</b>	Greenhouse Gas	
<b>GIS</b>	Geographical Information System	
<b>GISM</b>	Greenland Ice-Sheet Model	
<b>GISP</b>	Greenland Ice Sheet Project	<a href="http://nsidc.org/data/gisp_grip/index.html">http://nsidc.org/data/gisp_grip/index.html</a>
<b>GLOCHANT</b>	Global Change and the Antarctic	<a href="http://glochant.glochant_home.htm">GLOCHANT/glochant_home.htm</a>
<b>GMES</b>	Global Monitoring for Environment and Security	<a href="http://gmes.jrc.it/">http://gmes.jrc.it/</a>
<b>GMES-GATO</b>	GMES - Global Atmospheric Observations.	<a href="http://www.gmes-cca.co.uk">http://www.gmes-cca.co.uk</a>
<b>GNP</b>	Gross National Product	
<b>GOME</b>	Global Ozone Monitoring Experiment	<a href="http://earth.esa.int/services/esa_doc/doc_gom.html">http://earth.esa.int/services/esa_doc/doc_gom.html</a>
<b>GOMOS</b>	Global Ozone Monitoring by Occultation of Stars	<a href="http://envisat.esa.int/instruments/gomos/">http://envisat.esa.int/instruments/gomos/</a>
<b>GPS</b>	Global Positioning System	
<b>GRIP</b>	Greenland Ice Core Project	<a href="http://nsidc.org/data/gisp_grip/index.html">http://nsidc.org/data/gisp_grip/index.html</a>
<b>GSMA</b>	Molecular Spectroscopy and Atmospheric Applications Group (Groupe de Spectrométrie Moléculaire et Atmosphérique)	<a href="http://www.univ-reims.fr/Labos/GSMA/">http://www.univ-reims.fr/Labos/GSMA/</a>
<b>GWP</b>	Global Warming Potential	
<b>HadCM</b>	Hadley Centre Coupled Model	<a href="http://www.met-office.gov.uk/research/hadleycentre/models/modeltypes.html">http://www.met-office.gov.uk/research/hadleycentre/models/modeltypes.html</a>
<b>HadCM2</b>	Coupled atmosphere - ocean general circulation model	<a href="http://www.metoffice.com/research/hadleycentre/models/HadCM2.html">http://www.metoffice.com/research/hadleycentre/models/HadCM2.html</a>
<b>HALOE</b>	Halogen Occultation Experiment	<a href="http://haloedata.larc.nasa.gov/home.html">http://haloedata.larc.nasa.gov/home.html</a>
<b>HCFC</b>	Hydrochlorofluorocarbon	
<b>HDO</b>	Deuterated water vapour	
<b>HFC</b>	Hydrofluorocarbon	
<b>HGIS</b>	Hells Gate Ice Shelf	
<b>HITRAN</b>	High-resolution Transmission molecular absorption database	<a href="http://cfa-www.harvard.edu/hitran/">http://cfa-www.harvard.edu/hitran/</a>
<b>HSSW</b>	High Salinity Shelf Water	
<b>IASI</b>	Infrared Atmospheric Sounding Interferometer	
<b>IBGE</b>	The Brussels Institute for Management of the Environment (Institut Bruxellois pour la Gestion de l'Environnement - Brussels Instituut voor Milieubeheer)	<a href="http://www.ibgebim.be/">www.ibgebim.be/</a>
<b>ICDO-CIDD</b>	Interdepartmental Commission for Sustainable Development (Interdepartementale Commissie Duurzame Ontwikkeling - Commission Interdépartementale du Développement Durable)	<a href="http://www.icdo.fgov.be/">http://www.icdo.fgov.be/</a>
<b>ICE3D HO</b>	3D higher-order ice-sheet model	<a href="http://homepages.vub.ac.be/~fpattyn/3dmodel.html">homepages.vub.ac.be/~fpattyn/3dmodel.html</a>
<b>ICEDD</b>	Institut de Conseil et d'Etudes en Développement Durable	<a href="http://www.iwallon.be">http://www.iwallon.be</a>
<b>ICES</b>	Council for the Exploration of the Sea	<a href="http://www.ices.dk/">http://www.ices.dk/</a>
<b>ICP Forests</b>	International Co-operative Programme on Assessment and Monitoring of Air Pollution Effects on Forests	<a href="http://www.icp-forests.org/Index.htm">http://www.icp-forests.org/Index.htm</a>
<b>ICSU</b>	International Council of Scientific Unions	<a href="http://http://www.icsu.org/">http://http://www.icsu.org/</a>
<b>ICZM</b>	Integrated Coastal Zone Management	
<b>IEB</b>	Inter-Environnement Bruxelles (Belgium)	<a href="http://www.ieb.be/">http://www.ieb.be/</a>
<b>IGAC</b>	International Global Atmospheric Chemistry (IGBP)	<a href="http://www.igac.noaa.gov/">http://www.igac.noaa.gov/</a>
<b>IGACO</b>	Integrated Global Atmospheric Chemistry Observations	
<b>IGBP</b>	International Geosphere-Biosphere Programme	<a href="http://www.igbp.kva.se">http://www.igbp.kva.se</a>
<b>IGFA</b>	International Group of Funding Agencies for Global Change Research	<a href="http://www.geo.ucl.ac.be/LUCC/outreach/funding/world/IGFA.HTML">http://www.geo.ucl.ac.be/LUCC/outreach/funding/world/IGFA.HTML</a>
<b>IGOS</b>	Integrated Global Observing Strategy	<a href="http://www.igospartners.org/">http://www.igospartners.org/</a>
<b>IHDP</b>	International Human Dimensions Programme on Global Environmental Change	<a href="http://www.ihdp.uni-bonn.de/">http://www.ihdp.uni-bonn.de/</a>
<b>IIASA</b>	International Institute for Applied Systems Analysis	<a href="http://www.iiasa.ac.at/">http://www.iiasa.ac.at/</a>
<b>IMAGES</b>	Intermediate Model for the Annual and Global Evolution of Species	<a href="http://www.ucar.edu/communications/acronyms/1.html">http://www.ucar.edu/communications/acronyms/1.html</a>
<b>IMG</b>	Interferometric Monitor for Greenhouse	
<b>Interreg</b>	Interreg North Sea Programme	<a href="http://www.interregnorthsea.org/">http://www.interregnorthsea.org/</a>
<b>IOC</b>	Intergovernmental Oceanographic Commission	<a href="http://ioc.unesco.org/">http://ioc.unesco.org/</a>
<b>IPCC</b>	Intergovernmental Panel on Climate Change	<a href="http://www.ipcc.ch">http://www.ipcc.ch</a>
<b>IPCC SAR</b>	IPCC Second Assessment Report	<a href="http://www.ipcc.ch/">http://www.ipcc.ch/</a>
<b>IPCC SRES</b>	IPCC Special Report on Emission Scenarios	<a href="http://www.ipcc.ch/">http://www.ipcc.ch/</a>
<b>IPCC SYR</b>	IPCC Climate Change 2001: Synthesis Report	<a href="http://www.ipcc.ch/">http://www.ipcc.ch/</a>
<b>IPCC TAR</b>	IPCC Third Assessment Report - Climate Change 2001	<a href="http://www.ipcc.ch/">http://www.ipcc.ch/</a>
<b>IPSL</b>	Institut Pierre-Simon Laplace (France)	<a href="http://www.ipsl.jussieu.fr/">http://www.ipsl.jussieu.fr/</a>
<b>ISW</b>	Ice Shelf Water	
<b>IUFRO</b>	International Union of Forestry Research Organisations	<a href="http://www.iufro.org/">http://www.iufro.org/</a>
<b>IWT</b>	Flemish Institute for the promotion of Innovation through Science and Technology (Instituut voor de aanmoediging van Innovatie door Wetenschap en Technologie in Vlaanderen)	<a href="http://www.iwt.be">http://www.iwt.be</a>

## Annex 7: Acronyms and abbreviations *(continued)*

Name	Description	Website
<b>JGOFS</b>	Joint Global Ocean Flux Study	<a href="http://www.uib.no/jgofs/jgofs.html">http://www.uib.no/jgofs/jgofs.html</a>
<b>JRC</b>	Joint Research Centre (EC)	<a href="http://www.jrc.it/">http://www.jrc.it/</a>
<b>ka, kyr</b>	thousand years	
<b>KNMI</b>	Royal Dutch Meteorological Institute (Koninklijk Nederlands Meteorologisch Instituut)	<a href="http://www.knmi.nl/">http://www.knmi.nl/</a>
<b>LACTOZ</b>	Laboratory Studies of Chemistry Related to Tropospheric Ozone	
<b>LAQUAN</b>	Late Quarternary climate history of coastal Antarctic environments: a multi-proxy approach	<a href="http://www.laquan.ugent.be">www.laquan.ugent.be</a>
<b>LBA</b>	Large-scale Biosphere-Atmosphere Experiment in Amazonia	<a href="http://lba-ecology.gsfc.nasa.gov/lbaeco">http://lba-ecology.gsfc.nasa.gov/lbaeco</a>
<b>LGM</b>	Last Glacial Maximum	
<b>LIA</b>	Little Ice Age	
<b>LOCH</b>	an off-line three-dimensional (3-D) reaction-transport model of the marine carbon cycle	
<b>LOCH-API</b>	3-D Global Oceanic Carbon Cycle Model - Hamburg Max Planck Institute	
<b>LOCH-LUN</b>	3-D Global Oceanic Carbon Cycle Model - Louvain-La-Neuve	
<b>LOICZ</b>	Land-Ocean Interactions in the Coastal Zone (IGBP)	<a href="http://www.nioz.nl/loicz/">http://www.nioz.nl/loicz/</a>
<b>LOVECLIM</b>	Three-dimensional atmosphere-vegetation-sea-ice-ocean model with a model of the oceanic carbon cycle and with thermo-mechanical models of the Greenland and Antarctic ice sheets.	<a href="http://www.belspo.be/belspo/fedra/proj.asp?en&amp;COD=EV/09">www.belspo.be/belspo/fedra/proj.asp?en&amp;COD=EV/09</a>
<b>LPMA</b>	Laboratoire de Physique Moléculaire et Applications (France)	<a href="http://www.lpma.jussieu.fr/">http://www.lpma.jussieu.fr/</a>
<b>LRTAP</b>	Convention on Long-range Transboundary Air Pollution	<a href="http://www.unepce.org/env/lrtap/">http://www.unepce.org/env/lrtap/</a>
<b>LSU</b>	Land Surface Unit	
<b>LUCC</b>	Land Use and Cover Change (IGBP)	<a href="http://www.geo.ucl.ac.be/LUCC/">http://www.geo.ucl.ac.be/LUCC/</a>
<b>LUCF</b>	Land Use Change and Forestry	
<b>MAESTRO</b>	Measurements of Aerosol Extinction in the Stratosphere and Troposphere Retrieved by Occultation	<a href="http://www.space.gc.ca/asc/eng/csa_sectors/space_science/atmospheric/scisat/maestro.asp">http://www.space.gc.ca/asc/eng/csa_sectors/space_science/atmospheric/scisat/maestro.asp</a>
<b>MA</b>	Millennium Ecosystem Assessment	<a href="http://www.millenniumassessment.org/en/index.aspx">http://www.millenniumassessment.org/en/index.aspx</a>
<b>MAR</b>	Regional Atmospheric Model (Modèle Atmosphérique Régional)	
<b>MARE-DASM</b>	Marine Resources Damage Assessment and Sustainable Management of the North Sea	<a href="http://www.belspo.be/belspo/fedra/proj.asp?en&amp;COD=MN/DD1/007">www.belspo.be/belspo/fedra/proj.asp?en&amp;COD=MN/DD1/007</a>
<b>masl</b>	meters above sea level	
<b>MAST</b>	Monterey Area Ship Track	
<b>MAST</b>	Marine Science and Technology Programme (EU)	<a href="http://www.cordis.lu/mast/home.html">http://www.cordis.lu/mast/home.html</a>
<b>MCFPE</b>	Ministerial Conference on the Protection of Forests in Europe	<a href="http://www.minconf-forests.net/">www.minconf-forests.net/</a>
<b>METAGP</b>	Modelling Ecosystem Trace Gas Emissions	<a href="http://www.geo.ucl.ac.be/metagp/">http://www.geo.ucl.ac.be/metagp/</a>
<b>METOP-1</b>	Meteorological Operational satellite-2 (EUMETSAT)	
<b>MICROMAT</b>	Biodiversity of Microbial Mats in Antarctica	<a href="http://www.nerc-bas.ac.uk/mlsd/micromat/">http://www.nerc-bas.ac.uk/mlsd/micromat/</a>
<b>MILMO</b>	Modelling the evolution of climate and sea level over the Third Millennium	<a href="http://www.climate.be/research/MILMO/">http://www.climate.be/research/MILMO/</a>
<b>MINA</b>	Environment and Nature Council of Flanders (AMINAL)	<a href="http://www.mina.vlaanderen.be">http://www.mina.vlaanderen.be</a>
<b>MIPAS</b>	Michelson Interferometer for Passive Atmospheric Sounding	
<b>MIRA-S</b>	Report on the environment and nature in Flanders: scenario's (Milieu- en Natuurrapport: scenario's)	<a href="http://www2.vmm.be">http://www2.vmm.be</a>
<b>MIRA-T</b>	Report on the environment and nature in Flanders: themes (Milieu- en Natuurrapport: thema's)	<a href="http://www2.vmm.be">http://www2.vmm.be</a>
<b>MIRO&amp;CO</b>	3-Dimensional coupled physical-biological model	<a href="http://www.igbp.kva.se/obe/OBE_PS10.pdf">http://www.igbp.kva.se/obe/OBE_PS10.pdf</a>
<b>MoBidiC</b>	Bidimensional Climate Model (Modèle Bidimensionnel Climatique)	<a href="http://www.climate.be">www.climate.be</a>
<b>MOPITT</b>	Monitoring of Pollution In The Troposphere	
<b>MOZART</b>	Model of Ozone And Related Trace species	<a href="http://www.ucar.edu/communications/quarterly/winter99/MOZART.html">http://www.ucar.edu/communications/quarterly/winter99/MOZART.html</a>
<b>MRI</b>	Meteorological Research Institute (Japan)	<a href="http://www.mri-jma.go.jp/">http://www.mri-jma.go.jp/</a>
<b>MSA</b>	Methanesulfonic Acid	
<b>NADIR</b>	NILU Atmospheric Database for Interactive Retrieval	<a href="http://www.nilu.no/index.cfm?lan_id=3">http://www.nilu.no/index.cfm?lan_id=3</a>
<b>NAO</b>	North Atlantic Oscillation	
<b>NASA</b>	National Aeronautics and Space Administration (USA)	<a href="http://www.nasa.gov/">http://www.nasa.gov/</a>
<b>NCAR</b>	National Center for Atmospheric Research (USA)	<a href="http://www.ncar.ucar.edu/ncar/">http://www.ncar.ucar.edu/ncar/</a>
<b>NDSC</b>	Network for the Detection of Stratospheric Change	<a href="http://www.ndsc.ncep.noaa.gov/">http://www.ndsc.ncep.noaa.gov/</a>
<b>NEC</b>	National Emissions Ceilings	
<b>NEE</b>	Net Ecosystem Exchange	
<b>NEP</b>	Net Ecosystem Production	
<b>NERC</b>	Natural Environmental Research Council (UK)	<a href="http://www.nerc.ac.uk/">http://www.nerc.ac.uk/</a>
<b>NGO</b>	Non-Governmental Organisation	
<b>NH</b>	Northern Hemisphere	
<b>NILU</b>	Norwegian Institute for Air Research	<a href="http://www.nilu.no/">http://www.nilu.no/</a>
<b>NIPR</b>	National Institute of Polar Research (Japan)	<a href="http://www.nipr.ac.jp/">www.nipr.ac.jp/</a>
<b>NIRAS-</b>	Belgian Agency for Management of Radioactive Waste and Enriched Fissile	<a href="http://www.nirond.be/">http://www.nirond.be/</a>
<b>ONDRAF</b>	Materials (Nationale Instelling voor Radioactief Afval en Verrijkte Splijtingstoffen - Organisme National des Déchets Radioactifs et des Matières Fissiles Enrichies)	
<b>NIS</b>	Nansen Ice Sheet	
<b>NOAA</b>	National Oceanic and Atmospheric Administration (USA)	<a href="http://www.noaa.gov/">http://www.noaa.gov/</a>
<b>NPLS</b>	non-linear partial least squares regression	
<b>NPP</b>	Net Primary Production	
<b>nss</b>	non-sea salt	
<b>NSTF</b>	North Sea Task Force	
<b>NVOC</b>	Non-methane Volatile Organic Compounds	
<b>OBCM</b>	Oceanic Biogeochemical Climate Model	
<b>ODP</b>	Ozone Depletion Potential	
<b>OECD</b>	Organisation for Economic Co-operation and Development	<a href="http://www.oecd.org">www.oecd.org</a>
<b>OGCM</b>	Ocean General Circulation Model	
<b>OM</b>	Organic Matter	
<b>OMEX</b>	Ocean Margin Exchange	<a href="http://www.pol.ac.uk/bodc/omex/omex.html">http://www.pol.ac.uk/bodc/omex/omex.html</a>

## Annex 7: Acronyms and abbreviations *(continued)*

Name	Description	Website
<b>OMI</b>	Ozone Monitoring Instrument	
<b>ORA</b>	Occultation Radiometer	
<b>ORCALIM</b>	Ocean parallélisé-Louvain-la-Neuve Ice model	
<b>OSPAR</b>	Convention for the Protection of the Marine Environment of the North-East Atlantic	<a href="http://www.ospar.org/">http://www.ospar.org/</a>
<b>PAGES</b>	Past Global Changes (IGBP)	<a href="http://www.pages.unibe.ch/">http://www.pages.unibe.ch/</a>
<b>PAH</b>	Polycyclic Aromatic Hydrocarbons	
<b>PCM</b>	Parallel Climate Model	
<b>PM</b>	Particulate Matter	
<b>PM<sub>n</sub></b>	Particulate Matter of diameter lower than n micrometers	
<b>POAM-II and -III</b>	Polar Ozone and Aerosol Measurement; second & third phase	
<b>ppbv</b>	parts per billion (volume)	
<b>ppmv</b>	parts per million (volume)	
<b>PRODEX</b>	Scientific programme established to provide funding for the industrial development of scientific instruments or experiments	<a href="http://www.esa.int/export/esaCP/ASE0QUINW9SC_Benefits_0.html">http://www.esa.int/export/esaCP/ASE0QUINW9SC_Benefits_0.html</a>
<b>PSC</b>	Polar Stratospheric Cloud	
<b>PVC</b>	Poly Vinyl Chloride	
<b>R&amp;D</b>	Research and Development	
<b>RASAB</b>	The Royal Academies for Science and the Arts of Belgium	<a href="http://www.kvab.be/english/links.htm">http://www.kvab.be/english/links.htm</a>
<b>RCM</b>	Regional Climate Model	
<b>RIVM</b>	National Institute for Public Health and the Environment (Rijksinstituut voor Volksgezondheid en Milieu - the Netherlands)	<a href="http://www.rivm.nl/">http://www.rivm.nl/</a>
<b>SAFARI</b>	Southern African Regional Science Initiative	<a href="http://safari.gecp.virginia.edu/">http://safari.gecp.virginia.edu/</a>
<b>SAG</b>	Scientific Advisory Group	
<b>SAGE-II</b>	Stratospheric Aerosol and Gas Experiment II	<a href="http://www.sage2.larc.nasa.gov/">http://www.sage2.larc.nasa.gov/</a>
<b>SALE</b>	Subglacial Antarctic Lake Exploration	<a href="http://salegos-scar.montana.edu">http://salegos-scar.montana.edu</a>
<b>SAOZ</b>	Système d'Analyse par Observations Zénithales	
<b>SBSTTA</b>	Subsidiary Body on Scientific, Technical and Technological Advice	<a href="http://www.biodiv.org/convention/sbstta.asp">http://www.biodiv.org/convention/sbstta.asp</a>
<b>SCAR</b>	Scientific Committee on Antarctic Research	<a href="http://www.scar.org/">http://www.scar.org/</a>
<b>SCIAMACHY</b>	Scanning Imaging Absorption Spectrometer for Atmospheric Chartography	<a href="http://envisat.esa.int/instruments/sciamachy/">http://envisat.esa.int/instruments/sciamachy/</a>
<b>SCISAT</b>	Science Satellite	<a href="http://www.space.gc.ca/asc/eng/csa_sectors/space_science/atmospheric/scisat/scisat.asp">http://www.space.gc.ca/asc/eng/csa_sectors/space_science/atmospheric/scisat/scisat.asp</a>
<b>SCOR</b>	Scientific Committee on Oceanic Research	<a href="http://www.jhu.edu/~scor/">http://www.jhu.edu/~scor/</a>
<b>SD</b>	Sustainable Development	
<b>SERTIE</b>	Service de la Recherche, des Etudes et du Traitement de l'Information sur l'Environnement (France)	
<b>SESAME</b>	Second European Stratospheric Arctic and Mid-latitude Experiment	
<b>SH</b>	Southern Hemisphere	
<b>SIFT</b>	Selected Ion Flow Tube	
<b>SISCO</b>	Silica Retention in the Scheldt continuum and its Impact on Coastal Eutrophication	<a href="http://www.ulb.ac.be/sciences/dste/ocean/SISCO/frame.html">http://www.ulb.ac.be/sciences/dste/ocean/SISCO/frame.html</a>
<b>SLIMCAT</b>	3-D chemical transport model	
<b>SMAC</b>	Spectroscopic measurements of atmospheric changes	<a href="http://www.belspo.be/belspo/fedra/prog.asp?nl&amp;COD=GC">www.belspo.be/belspo/fedra/prog.asp?nl&amp;COD=GC</a>
<b>SME</b>	Small and Medium Enterprise	
<b>SMMR</b>	Scanning Multichannel Microwave Radiometer	
<b>SMMR</b>	Scanning Multichannel Microwave Radiometer	
<b>SMOCC</b>	Smoke Aerosols, Clouds, Rainfall and Climate: Aerosols from Biomass Burning	<a href="http://www.mpch-mainz.mpg.de/smocc/">http://www.mpch-mainz.mpg.de/smocc/</a>
<b>SOA</b>	Perturb Regional and Global Climate	
<b>SOA</b>	Secondary Organic Aerosols	
<b>SOC</b>	Soil Organic Carbon	
<b>SOI</b>	Southern Oscillation Index	
<b>SOIREE</b>	Southern Ocean Iron Enrichment Experiment	<a href="http://tracer.env.uea.ac.uk/soiree/">http://tracer.env.uea.ac.uk/soiree/</a>
<b>SOLVE</b>	SAGE III Ozone Loss Validation Experiment	<a href="http://cloud1.arc.nasa.gov/solve/">http://cloud1.arc.nasa.gov/solve/</a>
<b>SPARC</b>	Stratospheric Processes And their Role in Climate	<a href="http://www.aero.jussieu.fr/~sparc/">http://www.aero.jussieu.fr/~sparc/</a>
<b>SPOT</b>	Earth Observation Satellite (Satellite Pour l'Observation de la Terre)	
<b>SPOT4-VGT</b>	Version 4 of SPOT with a vegetation sensor	
<b>SPSD</b>	Scientific Support Plan for a Sustainable Development Policy (Belgium)	<a href="http://www.belspo.be/belspo/home/port_en.stm">http://www.belspo.be/belspo/home/port_en.stm</a>
<b>SSMI</b>	Special Sensor Microwave Imager	
<b>SST</b>	Sea Surface Temperature.	
<b>STADIV</b>	Index for quantifying functional status and stability of ecosystems	
<b>STEREO</b>	Support to the Exploitation and Research in Earth Observation	<a href="http://www.belspo.be/belspo/fedra/prog.asp?nl&amp;COD=SR">http://www.belspo.be/belspo/fedra/prog.asp?nl&amp;COD=SR</a>
<b>SWAMCO</b>	Seawater Microbial Community Model	
<b>sza</b>	solar zenith angle	
<b>TEMIS</b>	Tropospheric Emission Services	
<b>THESEO</b>	Third European Stratospheric Experiment on Ozone	<a href="http://www.nilu.no/projects/theseo2000/">http://www.nilu.no/projects/theseo2000/</a>
<b>TOMS</b>	Total Ozone Mapping Spectrometer	
<b>TSP</b>	Total Suspended Particulate matter	
<b>UARS</b>	Upper Atmosphere Research Satellite	<a href="http://spacelink.nasa.gov/NASA.Projects/Earth.Science/Atmosphere/Upper.Atmosphere.Research.Satellite/">http://spacelink.nasa.gov/NASA.Projects/Earth.Science/Atmosphere/Upper.Atmosphere.Research.Satellite/</a>
<b>UN</b>	United Nations	<a href="http://www.un.org/">http://www.un.org/</a>
<b>UNCCD</b>	United Nations Convention to Combat Desertification	<a href="http://www.unccd.int/main.php">http://www.unccd.int/main.php</a>
<b>UNCED</b>	United Nations Conference on Environment and Development	<a href="http://www.ciesin.org/TG/PI/TREATY/unced.html">http://www.ciesin.org/TG/PI/TREATY/unced.html</a>
<b>UNDP</b>	United Nations Development Programme	<a href="http://www.undp.org/">http://www.undp.org/</a>
<b>UNECE</b>	United Nations Economic Commission for Europe	<a href="http://www.unece.org/env/lrtap/">http://www.unece.org/env/lrtap/</a>
<b>UNEP</b>	United Nations Environment Programme	<a href="http://www.unep.org/">http://www.unep.org/</a>
<b>UNESCO</b>	United Nations Educational, Scientific and Cultural Organization	<a href="http://www.unesco.org/">www.unesco.org/</a>
<b>UNFCCC</b>	United Nations Framework Convention on Climate Change	<a href="http://www.unfccc.de/">http://www.unfccc.de/</a>
<b>USGCRP</b>	US Global Change Research Programme	<a href="http://www.usgcrp.gov/">http://www.usgcrp.gov/</a>
<b>UTLS</b>	Upper Troposphere/Lower Stratosphere	
<b>UV</b>	Ultraviolet	
<b>UV-A</b>	Ultraviolet with wavelengths 315-400 nm	
<b>UV-B</b>	Ultraviolet with wavelengths 280-315 nm	
<b>UV-C</b>	Ultraviolet with wavelengths less than 280 nm	

## Annex 7: Acronyms and abbreviations *(continued)*

Name	Description	Website
<b>UVI</b>	Ultra-Violet Index	
<b>UV-Visible</b>	Ultraviolet with wavelengths 400-800 nm	
<b>VECODE</b>	Vegetation Continuous Description model	
<b>VEGETATION</b>	Scientific support for the exploitation of the 'Vegetation' instrument	<a href="http://www.belspo.be/belspo/fedra/prog.asp?l=en&amp;COD=VG">http://www.belspo.be/belspo/fedra/prog.asp?l=en&amp;COD=VG</a>
<b>VELMAP</b>	Antarctic Ice Velocity Data	<a href="http://nsidc.org/data/velmap/velmap.html">http://nsidc.org/data/velmap/velmap.html</a>
<b>Vintersol</b>	Validation of International Satellites and Study of Ozone Loss	
<b>VLAREM</b>	Flemish Environmental Legislation (Vlaams reglement betreffende de milieuvergunning)	<a href="http://www.mina.be/vlarem.html">http://www.mina.be/vlarem.html</a>
<b>VLM</b>	Flemish Land Agency (Vlaamse Landmaatschappij)	<a href="http://www.vlm.be/Start.htm">http://www.vlm.be/Start.htm</a>
<b>VMM</b>	Flemish Environment Agency (Vlaamse Milieu Maatschappij)	<a href="http://www.vmm.be/">www.vmm.be/</a>
<b>VMR</b>	Volume Mixing Ratio	
<b>VOC</b>	Volatile Organic Compound	
<b>WAIS</b>	West Antarctic Ice Sheet	<a href="http://igloo.gsfc.nasa.gov/wais/">http://igloo.gsfc.nasa.gov/wais/</a>
<b>WCRP</b>	World Climate Research Programme	<a href="http://www.wmo.ch/web/wcrp/wcrp-home.html">http://www.wmo.ch/web/wcrp/wcrp-home.html</a>
<b>WG</b>	Working Group	
<b>WMO</b>	World Meteorological Organization	<a href="http://www.wmo.ch/">http://www.wmo.ch/</a>
<b>WMO GAW</b>	WMO Global Atmosphere Watch	<a href="http://www.wmo.ch/index-en.html">http://www.wmo.ch/index-en.html</a>
<b>WMO-UV</b>	WMO and Ultraviolet Radiation, Scientific Advisory Group	<a href="http://www.srnb.noaa.gov/UV/ssc.html">http://www.srnb.noaa.gov/UV/ssc.html</a>
<b>SAG</b>		
<b>WOUDC</b>	World Ozone and Ultraviolet Radiation Data Centre	<a href="http://www.woudc.org/">http://www.woudc.org/</a>
<b>WPIE/CC</b>	European Council's Working Party on International Environmental Issues - Climate Change	
<b>WRE</b>	World Reduction Emissions	
<b>WWF</b>	World Wide Fund For Nature	<a href="http://www.wwf.be/">http://www.wwf.be/</a>

## Annex 8: Abbreviations for chemical compounds and chemical formulae

Abbreviations			
Name	Description	Name	Description
CFC	Chlorofluorocarbon	NVOC	Non-methane Volatile Organic Compounds
DMS	Dimethyl Sulphide	PVC	Poly Vinyl Chloride
HCFC	Hydrochlorofluorocarbon	SOA	Secondary Organic Aerosols
HFC	Hydrofluorocarbon	SOC	Soil Organic Carbon
MSA	Methanesulfonic Acid	VOC	Volatile Organic Compound

Formulae			
Symbol	Name	Symbol	Name
Al	aluminium	HOBr	hypobromous acid
As	arsenic	HOCl	hypochlorous acid
Br	bromine	HO <sub>x</sub>	radical peroxy (HO) or hydroperoxy (HO <sub>2</sub> )
BrO	bromine monoxide	Hg, Hg <sup>2+</sup>	mercury, mercuric ion
BrONO <sub>2</sub>	bromine nitrate	Mg, Mg <sup>2+</sup>	magnesium, magnesium ion
C	carbon	Mn, Mn <sup>2+</sup>	manganese, manganese ion
Corg	organic carbon	N	nitrogen
<sup>12</sup> C	carbon radioisotope 12	Norg	organic nitrogen
<sup>13</sup> C	carbon radioisotope 13	N <sub>2</sub>	molecular nitrogen
<sup>14</sup> C	carbon radioisotope 14	N <sub>2</sub> O	nitrous oxide
CCl <sub>2</sub> F <sub>2</sub>	chlorofluorocarbon 12 (CFC-12)	N <sub>2</sub> O <sub>4</sub>	dinitrogen tetroxide
CCl <sub>3</sub> F	chlorofluorocarbon 11 (CFC-11)	NH <sub>3</sub>	ammonia
CHClF <sub>2</sub>	hydrochlorofluorocarbon 22 (HCFC-22)	NH <sub>4</sub> <sup>+</sup>	ammonium ion
CH <sub>3</sub> CCl <sub>3</sub>	methyl chloroform	NH <sub>4</sub> NO <sub>3</sub>	ammonium nitrate
CCl <sub>4</sub>	carbon tetrachloride	NO	nitric oxide
CH <sub>4</sub>	methane	NO <sub>2</sub>	nitrogen dioxide
C <sub>2</sub> H <sub>2</sub>	acetylene	NO <sub>x</sub>	total nitrogen oxides
C <sub>2</sub> H <sub>6</sub>	ethane	NO <sub>3</sub> <sup>-</sup>	nitrate ion
CH <sub>2</sub> O	formaldehyde	Ni	nickel
CH <sub>2</sub> O	carbohydrate (simplified formula for organic matter)	O	atomic oxygen
CO	carbon monoxide	<sup>18</sup> O	abundance of the oxygen isotope 18
CO <sub>2</sub> +A22	carbon dioxide	O <sub>2</sub>	molecular oxygen
CO <sub>3</sub> <sup>2-</sup>	carbonate ion	O <sub>3</sub>	ozone
COF <sub>2</sub>	carbonyl fluoride	OCIO	chlorine dioxide
COS	carbonyl sulphide	OH·	hydroxyl radical
Ca, Ca <sup>2+</sup>	calcium, calcium ion	P	phosphorus
CaCO <sub>3</sub>	calcium carbonate	Porg	organic phosphorus
Cd	cadmium	PO <sub>4</sub> <sup>3-</sup>	phosphate ion
Cl, Cl <sup>-</sup>	chlorine, chlorine ion	Pb	lead
ClO	chlorine monoxide radical	<sup>210</sup> Pb	lead radioisotope 210
ClONO <sub>2</sub>	chlorine nitrate	ROOH	alkyl hydroperoxides
Cl <sub>y</sub>	total inorganic chlorine	RO <sub>2</sub>	peroxy radical
Fe	iron	S	sulphur
H, H <sup>+</sup>	hydrogen, hydrogen ion	SF <sub>6</sub>	sulphur hexafluoride
H <sub>2</sub> O <sub>2</sub>	hydrogen peroxide	SO <sub>2</sub>	sulphur dioxide
H <sub>2</sub> SO <sub>4</sub>	sulphuric acid	SO <sub>4</sub> <sup>2-</sup>	sulphate ion
HCN	hydrogen cyanide	Si	silicium
HCO <sub>3</sub> <sup>-</sup>	bicarbonate ion	SiO <sub>2</sub>	silica or silicium dioxide (opal)
HDO	deuterated water vapour	Th	thorium
HF	hydrogen fluoride (hydrofluoric acid)	<sup>234</sup> Th	thorium radioisotope 234
HNO <sub>3</sub>	nitric acid	Zn	zinc



<b>SI (Système Internationale) Units</b>			
<b>Physical quantity</b>	<b>Name</b>	<b>Symbol</b>	
amount of substance	mole	mol	
length	meter	m	
mass	kilogram	kg	
time	second	s	
<b>Prefixes, fractions and multiplication factors of the international system SI</b>			
<b>Fraction</b>	<b>Prefix</b>	<b>Symbol</b>	
10 <sup>-1</sup>	deci	d	
10 <sup>-2</sup>	centi	c	
10 <sup>-3</sup>	milli	m	
10 <sup>-6</sup>	micro	μ	
10 <sup>-9</sup>	nano	n	
10 <sup>-12</sup>	pico	p	
10 <sup>-15</sup>	femto	t	
<b>Multiple</b>	<b>Prefix</b>	<b>Symbol</b>	
10	deca	da	
10 <sup>2</sup>	hecto	h	
10 <sup>3</sup>	kilo	k	
10 <sup>6</sup>	mega	M	
10 <sup>9</sup>	giga	G	
10 <sup>12</sup>	tera	T	
10 <sup>15</sup>	peta	P	
<b>SI-derived and other units</b>			
<b>Physical quantity</b>	<b>Name</b>	<b>Symbol</b>	<b>Definition</b>
pressure	bar	b or bar	
quantity	parts per million (10 <sup>6</sup> )	ppm	
length	micron	μm	
column density	Dobson Unit	DU	2.687*10 <sup>16</sup> ozone molecules per cm <sup>2</sup>
mass	gram	g	
mass	ton, tonne	t	
area	square metre	m <sup>2</sup>	
area	hectare	ha	10,000 m <sup>2</sup>
temperature	degree Celcius	°C	
time	year	yr	
power/radiant flux	watt	W	m <sup>2</sup> .kg.s <sup>-3</sup> (energy per unit time)
content	cubic metre	m <sup>3</sup>	
content	liter	l	
content	parts per billion(10 <sup>9</sup> ) by volume	ppbv	
content	parts per million (10 <sup>6</sup> ) by volume	ppmv	
degree of acidity	potential of Hydrogen	pH	
<b>Special symbols</b>			
<b>Physical quantity</b>	<b>Name</b>	<b>Symbol</b>	
length	diameter	Ø	

## Annex 10: Funding sources for global change research used by Belgian researchers

	Acronym	Website
<b>Belgium</b>		
<i>French Community</i>		
Actions de Recherches Concertées (Concerted Research Actions)	ARC	
Commisariat Général aux Relations Internationales	CGRI	<a href="http://www.wbri.be">http://www.wbri.be</a>
Direction Générale de l'Enseignement non obligatoire et de la Recherche Scientifique	DGENORS	<a href="http://www.enseignement.be">http://www.enseignement.be</a>
Fonds National de la Recherche Scientifique	FNRS	<a href="http://www.fnrs.be">http://www.fnrs.be</a>
<i>Ministry of the Flemish Community</i>		
Administratie Wetenschap en Innovatie (Science and Innovation Administration)	AWI	<a href="http://www.innovatie.vlaanderen.be">http://www.innovatie.vlaanderen.be</a>
Bijzonder Onderzoeksfonds (Special Research Fund)	BOF	
Fonds voor Wetenschappelijk Onderzoek - Vlaanderen (Fund for Scientific Research - Flanders)	FWO	<a href="http://sun.fwo.be">http://sun.fwo.be</a>
Instituut voor de Aanmoediging van Innovatie door Wetenschap en Technologie in Vlaanderen (Institute for the Promotion of Innovation through Science and Technology in Flanders)	IWT	<a href="http://www.iwt.be">http://www.iwt.be</a>
Programma Beleidsgericht Onderzoek	PBO	<a href="http://www.innovatie.vlaanderen.be">http://www.innovatie.vlaanderen.be</a>
Vlaamse landmaatschappij (Flemish Land Agency)	VLM	<a href="http://www.vlm.be">http://www.vlm.be</a>
Geconcerteerde Onderzoeksacties (Concerted Research Actions)	universities	
<i>Federal</i>		
Federal Science Policy	BELSPO	<a href="http://www.belspo.be">http://www.belspo.be</a>
King Léopold III Fund for Nature Exploration and Conservation		
Ministry of Small Traders and Agriculture (before 2002)		<a href="http://cmlag.fgov.be">http://cmlag.fgov.be</a>
National Fund for Scientific Research (before 1992)	FNRS-NFWO	
National Lottery		<a href="http://www.loterie-nationale.be">http://www.loterie-nationale.be</a>
<b>International</b>		
<i>European Union</i>		
COST (European Cooperation in the field of Scientific and Technical Research)	COST	<a href="http://cost.cordis.lu/src/home.cfm">http://cost.cordis.lu/src/home.cfm</a>
European Structural Funds	EU - InterReg	<a href="http://europa.eu.int/comm/regional_policy/index_en.htm">http://europa.eu.int/comm/regional_policy/index_en.htm</a>
European Commission - Framework Programmes	EC- FP	<a href="http://www.cordis.lu/en/src/d_001_en.htm">http://www.cordis.lu/en/src/d_001_en.htm</a>
<i>Other</i>		
European Space Agency - Scientific Experiment Development Programme	ESA-PRODEX	<a href="http://www.esa.int">http://www.esa.int</a>
European Space Agency - Data User Programme	ESA-DUP	<a href="http://dup.esrin.esa.it">http://dup.esrin.esa.it</a>
European organisation for the exploitation of Meteorological Satellites	EUMETSAT	<a href="http://www.eumetsat.de">http://www.eumetsat.de</a>
International Atomic Energy Agency	IAEA	<a href="http://www.iaea.or.at">http://www.iaea.or.at</a>
<b>Various sponsors</b>		
France - Centre National de la Recherche Scientifique	CNRS	<a href="http://www.cnrs.fr">http://www.cnrs.fr</a>
France - Association Amicale des Expéditions Polaires Françaises	AAEPF	<a href="http://www.aaepf.org">http://www.aaepf.org</a>
Germany - Deutsche Forschungsgemeinschaft	DFG	<a href="http://www.dfg.de">www.dfg.de</a>
Italy - Progetto Nazionale di Recerca in Antartide	PNRA	<a href="http://www.pnra.it/index.html">http://www.pnra.it/index.html</a>
Japan - Japan Society for the Promotion of Science	JSPS	<a href="http://www.jsps.org">www.jsps.org</a>
Netherlands - Rijkswaterstaat	RWS	<a href="http://www.verkeerenwaterstaat.nl/?lc=nl">http://www.verkeerenwaterstaat.nl/?lc=nl</a>
New Zealand - Antarctica New Zealand		<a href="http://www.antarcticanz.govt.nz">http://www.antarcticanz.govt.nz</a>
New Zealand - Industrial Research Ltd.	IRL	<a href="http://www.irl.cri.nz">http://www.irl.cri.nz</a>
New Zealand - Royal Society of New Zealand - Marsden Fund	RSNZ	<a href="http://www.rsnz.org/funding/marsden_fund">http://www.rsnz.org/funding/marsden_fund</a>
UK - British Antarctic Survey	BAS	<a href="http://www.antarctica.ac.uk">http://www.antarctica.ac.uk</a>
USA - National Science Foundation	NSF	<a href="http://www.nsf.gov">http://www.nsf.gov</a>
USA - National Aeronautics and Space Administration - Jet Propulsion Laboratory	NASA-JPL	<a href="http://www.jpl.nasa.gov">http://www.jpl.nasa.gov</a>

**Note:** This is a non exhaustive list, primarily based on the data provided by Belgian scientists during the assessment and integration process.

**European Community:**

**1996.** Council Directive 96/62/EC of 27 September 1996 on ambient air quality assessment and management. Official Journal of the European Communities, L 296 , 21/11/1996. pp. 55-63.

**1997.** European Research in the Stratosphere - The contribution of EASOE and SESAME to our current understanding of the ozone layer. EC-Report EUR 16986. European Commission – DGXII. ISBN 92-827-9719-8.

**2001.** European Research in the Stratosphere 1996-2000 – Advances in our understanding of the ozone layer during THESEO. EC-Report EUR 19867. European Commission – DGXII. ISBN 92-894-1398-0.

**2002.** Directive 2002/3/EC of the European Parliament and of the Council of 12 February 2002 relating to ozone in ambient air. Official Journal of the European Communities, L 67, 9/3/2002. pp. 14-30.

**Herzog, H., Caldeira, K. and Adams, E., 2001.** Carbon sequestration via direct injection. In Encyclopedia of Ocean Sciences Vol.1. Eds. Steele, J.H., Thorpe, S.A. and Turekian, K.K. pp. 408-414. Academic Press, London, UK.

**Intergovernmental Panel on Climate Change (IPCC):**

**1995.** IPCC Second Assessment Report: Climate Change 1995 (IPCC SAR)

**1995.** Climate Change 1994: Radiative Forcing of Climate Change and An Evaluation of the IPCC IS92 Emissions Scenarios. Houghton, J.T., Meira Filho, L.G., Bruce, J.P., Lee, H., Callander, B.A. and Haites, E.F. (ed.). Cambridge University Press, UK. ISBN 0521559626, 9780521559621.

**1996.** Revised 1996 IPCC guidelines for national greenhouse gas inventories. Vols 1–3. Houghton, J.T., Meira Filho, L.G., Lim, B., Treanton, K., Mamaty, I., Bonduki, Y., Griggs, D.J. and Callender, B.A. (ed.). IPCC/OECD/IEA. UK Meteorological Office, Bracknell. ([www.ipcc-nggip.iges.or.jp/public/gl/invs1.htm](http://www.ipcc-nggip.iges.or.jp/public/gl/invs1.htm)).

**1999.** Aviation and the Global Atmosphere. Penner J.E., Lister, D., Griggs, D.J., Dokken, D.J. and McFarland, M. Cambridge University Press, Cambridge, UK. ISBN 0 521 66404 7.

**2000.** Emissions Scenarios (IPCC SRES). Nakicenovic, N. and Swart, R. (ed.). Cambridge University Press. Cambridge, UK. ISBN 0 521 80493 0.

**2001.** IPCC Third Assessment Report: Climate Change 2001 (IPCC TAR):

Climate Change 2001: The Scientific Basis. Contribution of Working Group I to the Third Assessment Report of the Intergovernmental Panel on Climate Change. Houghton, J.T., Ding, Y., Griggs, D.J., Noguer, M., van der Linden, P.J., Dai, X., Maskell, K. and Johnson, C.A. (ed.). Cambridge University Press, Cambridge, UK. ISBN 0521 01495 6.

Climate Change 2001: Impacts, Adaptation and Vulnerability. Contribution of Working Group II to the Third Assessment Report of the Intergovernmental Panel on Climate Change. McCarthy, J.J., Canziani, O.F., Leary, N.A., Dokken, D.J. and White, K.S. (ed.). Cambridge University Press, Cambridge, UK. ISBN 0 521 01500 6.

Climate Change 2001: Synthesis Report (IPCC SYR). Contribution of Working Groups I, II, and III to the Third Assessment Report of the Intergovernmental Panel on Climate Change. Watson, R.T. et al (ed.). Cambridge University Press, Cambridge, UK. ISBN 0 521 01507 3.

**Letens, S., Van Orshoven, J., van Wesemael, B. and Muys, B., 2004.** Soil organic and inorganic carbon content of landscape units in Belgium for 1950-1970. Soil Use and Management 20. pp. 40-47.

**Manzani, M., 2001.** La natura dell'Antartide, Springer. pp. 39 and 197.

**Pussinen, A., Schelhaas, M.J., Verkaik, E., Nabuurs, G.J., 2000.** Manual of the EFISCEN Model. European Forest Institute, Joensuu, Finland. (internal report).

**United Nations Economic Commission for Europe (UNECE), 1991.** Protocol concerning the Control of Emissions of Volatile Organic Compounds or their Transboundary Fluxes. UNECE, Geneva, Switzerland, 18 November 1991.

**United Nations Environmental Programme (UNEP), 1998.** Environmental Effects of Ozone Depletion: 1998 Assessment, November 1998. UNEP, Nairobi, Kenya. ISBN 92-807-1724-3.

**Vanongeval, L. et al., 1998.** Vermesting. In: Verbruggen, A. (Ed.). MIRA-T 1998. Milieu- en Natuurrapport Vlaanderen: thema's. Vlaamse Milieu Maatschappij, Brussel, p. 191-206.

**Wollast, R. and Chou, L., 1998.** Distribution and fluxes of calcium carbonate along the continental margin in the Gulf at Biscay. Aquatic Geochem. 4, pp. 369-393.

**Wollast, R. and Mackenzie, F., 1989.** Global biochemical cycles and climate. NATO, ASI series, 285, pp. 453-473.

**World Meteorological Organization (WMO):**

**1999.** Scientific assessment of ozone depletion, 1998. Global Ozone Research and Monitoring Project (GORMP) report no. 44. ISBN 92-807-1722-7.

**2003.** Scientific assessment of ozone depletion, 2002: pursuant to Article 6 of the Montreal Protocol on substances that deplete the Ozone Layer. Global Ozone Research and Monitoring Project (GORMP) report no. 47. ISBN 92-807-2261-1.



## **Belgian global change research 1990-2002 : Assessment and integration report**

**Editors: G. den Ouden - gerard.den.ouden@telenet.be - tel: +32-2-7676803,  
M. Vanderstraeten - BELSPO - vdst@belspo.be - tel: +32-2-2383610**

**Scientific editors: R. Ceulemans, M. De Mazière, I. Nijs, J.-P. Vanderborght,  
R. Wollast, J.-P. van Ypersele, R. Zander**

**Depot nr. D/2004/1191/48**

**Layout: Mainpress**

**Language correction: Kathleen Broman**

**Printed by: Van In, Lier**

**Legal notice**

**A publication from Belgian Federal Science Policy Office, 2004**

**The Belgian Federal Science Policy Office has the mission of maximising Belgium's scientific and cultural potential in the service of policy-makers, scientists, the industrial sector and ordinary citizens: "a policy by science for science". Extracts from this publication may be reproduced provided that the reproduction is not of any commercial nature and tallies with the aforementioned Belgian Federal Science Policy Office mission. The Belgian Government cannot be held responsible for any damage resulting from the use of data contained in this publication.**

BELGIAN SCIENCE POLICY

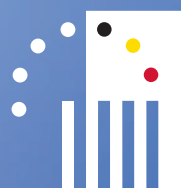

Wetenschapsstraat 8 rue de la Science  
Brussel 1000 Bruxelles  
[www.belspo.be](http://www.belspo.be)